

YASKAWA

REGENERATIVE CONVERTER UNIT D1000

EN

DE



D1000
D1000
D1000
D1000
D1000

Content

- ▶ 02 **About YASKAWA**
A Leader in Inverter Drives Technology
- ▶ 03 **The Power Regenerative Converter Unit**
- ▶ 04 **Discover new Energy Saving Potentials**
- ▶ 05 **Applications**
- ▶ 06 **Package Selection**
- ▶ 08 **Model Code Designation**
- ▶ 09 **D1000 Packages**
- ▶ 10 **Specifications, Parts and Options**
- ▶ 11 **Connection Diagrams and System Components**

Experience and Innovation

Since 1915 YASKAWA has manufactured and supplied products for machine building and industrial automation. Our standard products as well as tailor-made solutions are well known and have a high reputation for outstanding quality and reliability.

YASKAWA is the leading global manufacturer of inverter drives, servo drives, machine controllers, medium voltage inverters, and industrial robots.

We have always been a pioneer in motion control and drive technology, launching product innovations, which optimise the productivity and efficiency of both machines and systems.

Today we produce more than 1.9 million inverters per year. Considering this, YASKAWA is probably the biggest inverter manufacturer in the world.

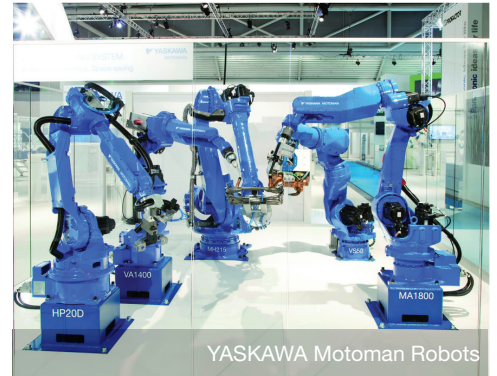

Furthermore, with a yearly production of more than 1 million servo motors and 25,000 robots we offer a wide range of products for drive automation processes in many different industries. YASKAWA technology is used in all fields of machine building and industrial automation.



Wherever You Are – Our Local Support is Near



Employing more than 14,600 people worldwide

More than 1,350 employees in worldwide service network

More than 1,500 employees in Europe

The Power Regenerative Converter Unit

The D1000 regenerative converter unit complements the YASKAWA product range with a low harmonics Active Frontend Solution. Suitable for both regenerative individual drives and systems of inverter drives, servo axis or robots, the D1000 feeds excess braking energy back into the power grid instead of dissipating it as heat.



ENERGY EFFICIENT FOUR-QUADRANT

D1000 saves energy by making excess braking energy available to other consumers in the same grid instead of wasting it as heat. By providing full braking power with 100% duty cycle it allows for shorter machine cycles and can increase production efficiency.

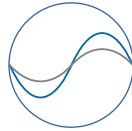

CLEAN POWER

The sinusoidal input current with a total harmonic distortion of less than 5% and a displacement power factor of ~1 minimize losses in grid components like generators and transformers. The higher power quality additionally reduces the potential disturbance of other components.

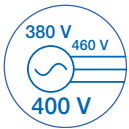

LOCATION INDEPENDENT MACHINE PERFORMANCE

A controlled, boostable DC voltage guarantees the same level of DC voltage independent of the power supply voltage. Connected drives are always supplied with the same DC voltage, making machines invulnerable against locally different power supply conditions and assuring the same machine performance, no matter where it is used.



COOL OPERATION

D1000 does away with braking choppers and resistors, thus saving valuable space and reducing the risk of fire. By not dissipating energy as heat the demand for ventilation is greatly reduced and maintenance, e.g. for resistor cleaning becomes needless.



READY FOR GLOBAL USE

D1000 complies with major global standards such as UL, CE, RoHS and others.



REDUCE COSTS

D1000 reduces the cost for energy and maintenance and quickly pays for itself.



EASY TO HANDLE PACKAGE

D1000 comes in an easy to handle package. Only one material number for all components makes procurement simple and assures completeness and parts compatibility.



Save Energy with Power Regeneration

D1000 is open for various configurations. Usable in one-on-one or multiple unit connection the D1000 provides the flexibility needed to satisfy a broad range of energy efficient and low harmonics applications.

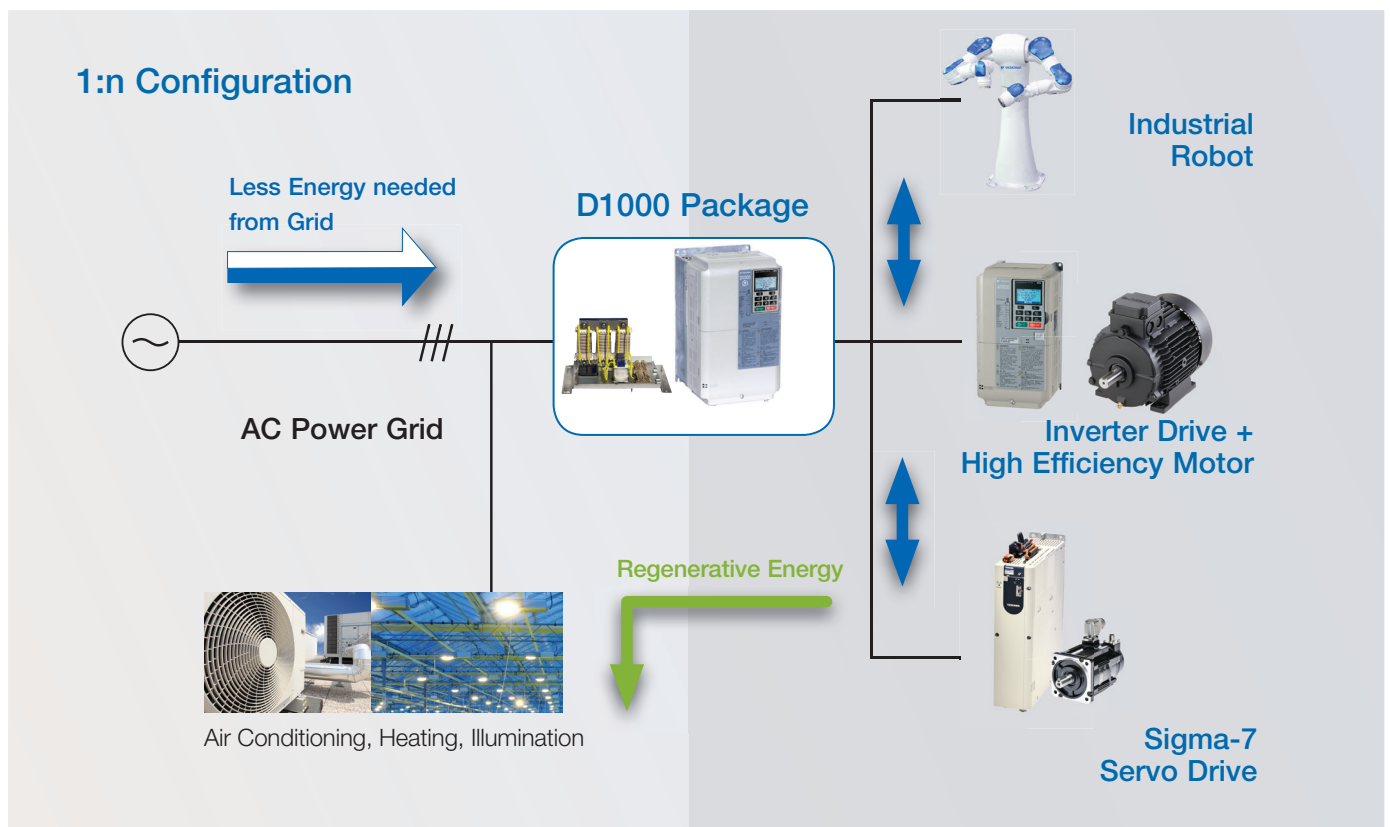

One-on-One System

Typical one-on-one applications like escalators, elevators, pumps or presses have one inverter drive connected to a D1000. Using the D1000 they take great benefit from:

- ▶ Energy cost reduction of complete installation
- ▶ Less space and heat by removed braking resistors
- ▶ Low input current harmonics

Multiple-Unit Connection

Multiple unit systems like winders, transport systems, packaging systems or hoists with inverter drives, servo systems or robots have an interconnected DC bus that is supplied by a single D1000. Energy is shared already in the DC bus, leading to reduced take up from the power grid. In addition to the benefit of one-on-one systems such applications take advantages from:

- ▶ DC bus energy sharing
- ▶ Reduced space compared to multiple drives with built-in active frontend
- ▶ Single point of supply

For a Wide Range of Applications

Using the D1000 Regenerative Converter Unit saves energy and thereby money within a broad range of applications. This includes applications with large-inertia loads, 4-quadrant loads, long-term energy feedback and quick braking.



- ▶ Centrifugal separators
- ▶ Eccentrics

- ▶ Presses

Single Unit Configuration (1:1)

For configurations with only one drive connected to a D1000 the correct D1000 Kit can be selected from the tables below.

200 V Class

Motor Capacity (kW) / Drive Capacity (kW)	D1000 Kit D1KIT2□□□AAAAA
≤4.0	0005
5.5 / 7.5	0010
11 / 15	0020
18.5 / 22	0030
30 / 37	0050
45 / 55	0065
75	0090
90 / 110	0130

400 V Class

Motor Capacity (kW) / Drive Capacity (kW)	D1000 Kit D1KIT4□□□□AB
≤4.0	0005
5.5 / 7.5	0010
11 / 15	0020
18.5 / 22	0030
30	0040
37 / 45	0060
55 / 75	0100
90 / 110	0130
132 / 160	0185
185 / 220	0270
315	0370
450 / 560	0630

Multiple Unit Configuration (1:n)

Selecting the optimal D1000 Kit when multiple units are connected to one D1000 requires an analysis of the application. Find the moments of maximum motoring and regenerative power as shown in the example below, compare them and select the right D1000 kit.

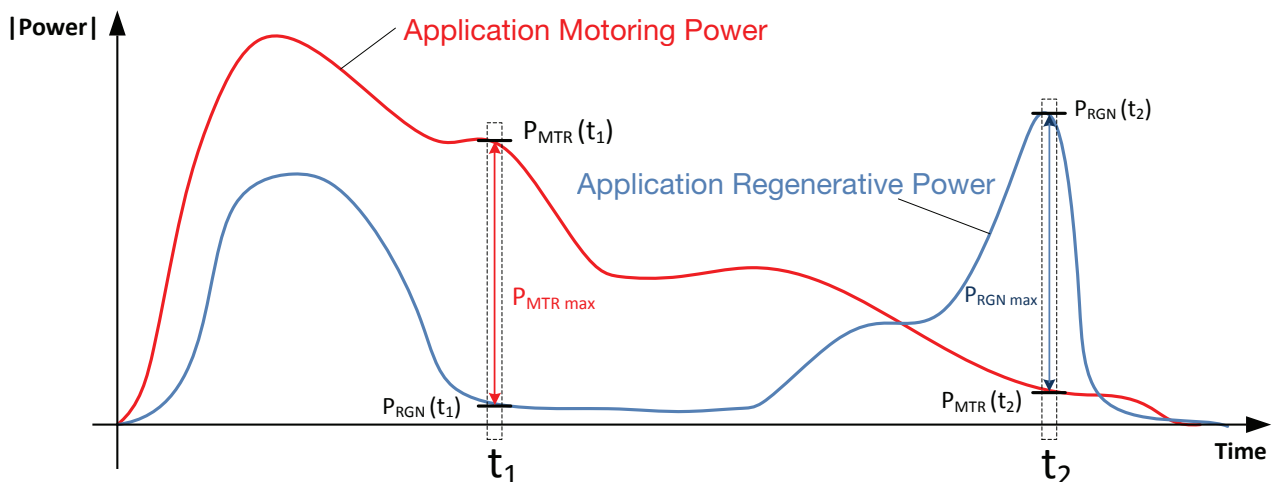

Calculating the Capacity for Multiple Units

Definitions

P = Power [kW]

η = Efficiency

P_{MTR} = Motoring Power

P_{RGN} = Regenerative Power

$$P_{MTR}(t) = \sum_{i=1}^N \frac{P_{motor\ i}(t)}{\eta_{motor\ i} \cdot \eta_{drive\ i}}$$

$$P_{RGN}(t) = \sum_{i=1}^N P_{motor\ i}(t) \cdot \eta_{motor\ i} \cdot \eta_{drive\ i}$$

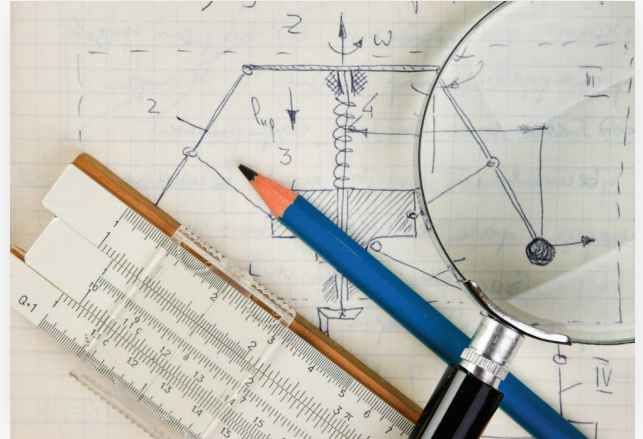

1. Determine the moment (t_1) when the application draws the maximum motoring power from the grid and calculate the power by subtracting the total motoring and regenerative values.

$$P_{MTRmax} = P_{MTR}(t_1) - P_{RGN}(t_1)$$

2. Determine the moment (t_2) when the application returns the maximum regenerative power to the grid, and calculate the power by subtracting the total regenerative and motoring values.

$$P_{RGNmax} = P_{RGN}(t_2) - P_{MTR}(t_2)$$

3. Select a D1000 with a power rating greater than P_{MTRmax} or P_{RGNmax} , whichever is higher.

Notes

- ▶ The minimum D1000 power rating is 1/3 of the total nominal power rating of all devices connected to the DC bus.
- ▶ If the peak power state has a duration of less than 60 seconds, the D1000 overload capability can be taken into account. This requires a closer analysis of the application. For technical assistance please contact YASKAWA Support.
- ▶ If efficiencies are unknown, use a motor efficiency of 0.9 (0.85 for motors <7.5 kW) and a drive efficiency of 0.95.
- ▶ When calculating the motoring or regenerative power, the actual shaft power should be used. This is because some devices like Servopacks can provide up to 300% of nominal power for a short time, which can have significant influence on D1000 selection.
- ▶ When connecting devices to the DC bus that do not have their own precharge circuit there is a limit to the amount of capacitance that can be connected to the D1000. For more information please contact YASKAWA Support.
- ▶ If the interphase imbalance ratio of the power source exceeds 2%, select a D1000 unit one size larger than required by the above calculation.

Model Number Key for the D1000 Package

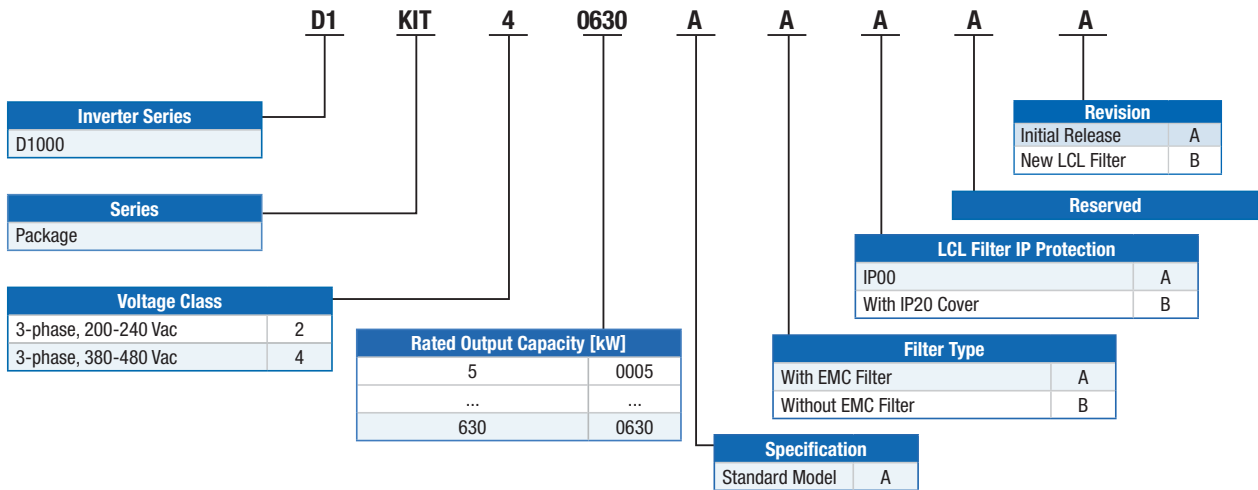

D1000 Package Example



D1000 Packages

D1000 is available in pre-configured packages that include all peripherals required, making the selection and procurement simple and easy.

Package Content

- ▶ D1000 Regenerative Converter Unit
- ▶ EMC Filter (optional)
- ▶ Harmonic filter module or harmonic filter kit

200 V Class

Capacity	Part Number Kit	Part Number		
[kW]	Order Number	D1000 Unit	Input Reactor 1	Harmonic Filter
5	D1KIT20005ABAAA	CIMR-DC2A0005BAA	100-106-071	EJJ710800.KM
10	D1KIT20010ABAAA	CIMR-DC2A0010BAA	100-106-072	EJJ710810.KM
20	D1KIT20020ABAAA	CIMR-DC2A0020BAA	100-106-073	EJJ710820.KM
30	D1KIT20030ABAAA	CIMR-DC2A0030AAA	100-106-074	EJJ710830.KM
50	D1KIT20050ABAAA	CIMR-DC2A0050AAA	100-106-075	EJJ710840.KM
65	D1KIT20065ABAAA	CIMR-DC2A0065AAA	100-106-076	EJJ710850.KM
90	D1KIT20090ABAAA	CIMR-DC2A0090AAA	100-106-077	EJJ710860.KM
130	D1KIT20130ABAAA	CIMR-DC2A0130AAA	100-106-078	EJJ710871.KM

400 V Class

Capacity	Part Number Kit	Part Number			
[kW]	Order Number	D1000 Unit	Harmonic Filter	EMC Filter (optional)	IP20 Cover (optional)
5	D1KIT40005A□□AB	CIMR-DC4A0005BAA	B84143G0008R176	B84143A0020R106	B84143Q0008R176
10	D1KIT40010A□□AB	CIMR-DC4A0010BAA	B84143G0016R176	B84143A0020R106	B84143Q0016R176
20	D1KIT40020A□□AB	CIMR-DC4A0020BAA	B84143G0030R176	B84143A0035R106	B84143Q0016R176
30	D1KIT40030A□□AB	CIMR-DC4A0030AAA	B84143G0043R176	B84143A0065R106	B84143Q0043R176
40	D1KIT40040A□□AB	CIMR-DC4A0040AAA	B84143G0058R176	B84143A0065R106	B84143Q0043R176
60	D1KIT40060A□□AB	CIMR-DC4A0060AAA	B84143G0086R176	B84143B0180S080	-
100	D1KIT40100A□□AB	CIMR-DC4A0100AAA	B84143G0145R176	B84143B0180S080	-
130	D1KIT40130A□□AB	CIMR-DC4A0130AAA	B84143G0210R176	B84143B0400S080	-
185	D1KIT40185A□□AB	CIMR-DC4A0185AAA	B84143G0300R176	B84143B0400S080	-
270	D1KIT40270A□□AB	CIMR-DC4A0270AAA	B84143G0410R176	B84143B1000S080	-
370	D1KIT40370A□□AB	CIMR-DC4A0370AAA	B84143G0560S176	B84143B1000S080	-
630	D1KIT40630A□□AB	CIMR-DC4A0630AAA	B84143G1140S176	B84143B1600S080	-



D1000 Specifications

Operating Environment

- ▶ **Ambient Temperature** -10 to +50 °C (open chassis)
- ▶ **Humidity** 95% RH or less (non condensating)
- ▶ **Storage Temperature** -20 to +60 °C (short-term temperature during transportation)
- ▶ **Altitude** Up to 1000 meters (output derating required above 1000 m, max. 3000 m)
- ▶ **Vibration/Shock**
 - 10 to 20 Hz at 9.8 m/s², 20 to 55 Hz at 5.9 m/s² (2A0005 to 2A0050, 4A0005 to 4A0100)
 - 10 to 20 Hz at 9.8 m/s², 20 to 55 Hz at 2.0 m/s² (2A0065 to 2A0130, 4A0130 to 4A0370)
 - 10 to 20 Hz at 5.9 m/s², 20 to 55 Hz at 2.0 m/s² (4A0630)
- ▶ **Protection Design** IP00/IP20 Open Type enclosure, Indoor use
- ▶ **Standards** UL508C, IEC 61800-5-1, IEC 61800-3, RoHS

Power Ratings

CIMR-DC□A□□□□	200 V Class								400 V Class											
	0005	0010	0020	0030	0050	0065	0090	0130	0005	0010	0020	0030	0040	0060	0100	0130	0185	0270	0370	0630
Maximum Applicable Motor Capacity (kW)	3.7	7.5	15	22	37	55	75	110	3.7	7.5	15	22	30	45	75	110	160	220	315	560
Rated Output Capacity (kW)	5	10	20	30	50	65	90	130	5	10	20	30	40	60	100	130	185	270	370	630
Rated Output Current DC (A)	15	30	61	91	152	197	273	394	8	15	30	45	61	91	152	197	280	409	561	955
Rated Input Current AC (A)	12	29	57	83	140	200	270	400	8	16	30	43	58	86	145	210	300	410	560	1040
Rated Output Voltage (Vdc)	330								660											
Overload Capability	Operation stops after 60 s at 150% of rated output current																			
Rated Voltage	200 to 240 VAC -15 to +10%								380 to 480 VAC -15 to +10%											
Rated Frequency	50/60 Hz ± 2%																			
Input Power Factor	Input power factor of 0.99 min (for rated operation)																			
Output Voltage Accuracy	±5%																			
Carrier Frequency	6				4				6				4				2			
Power Supply Frequency Fault	Operation stops for a deviation of ±6 Hz or more from the rated input frequency																			

Options

Item	Description	Model Code	
Input / Output	▶ Analogue Monitor	2 channel analogue output option -10 to +10 VDC (Res. 1/2048)	AO-A3
	▶ Digital Output	8 channel digital output option 6 photo couplers (48 V, 50 mA or less), 2 relay contact outputs max 250 VAC/30 VDC, 1 A	DO-A3
Communication	▶ Communication Interface Unit	CANopen	under development
		CC-Link	SI-C3
		DeviceNet	SI-N3
		EtherCAT	SI-ES3
		EtherNet/IP	SI-EN3, SI-EN3D
		MECHATROLINK-II	SI-T3
		Modbus/TCP	under development
		POWERLINK	under development
PROFIBUS-DP	SI-P3		
PROFINET	SI-EP3		
Others	▶ 24 V Power Supply	Provides power supply for the control circuit and option boards when main circuit power is off	PS-A10LB PS-A10HB
	▶ USB Copy Unit	USB converter for PC Tool usage and copy unit for easy parameter setup duplication and backup in one	JVOP-181
	▶ IP65 Operator Mounting Frame	Provides a simple way of installing the LCD Remote Operator of the drive on a cabinet wall or door	JVOP-V11001
	▶ Heatsink Outside Mounting Kit	Mount the drive with heatsink outside of the panel	EZZ020800□
	▶ DriveWizard Plus	Software used for parameter management and editing	

Standard Connection Diagram

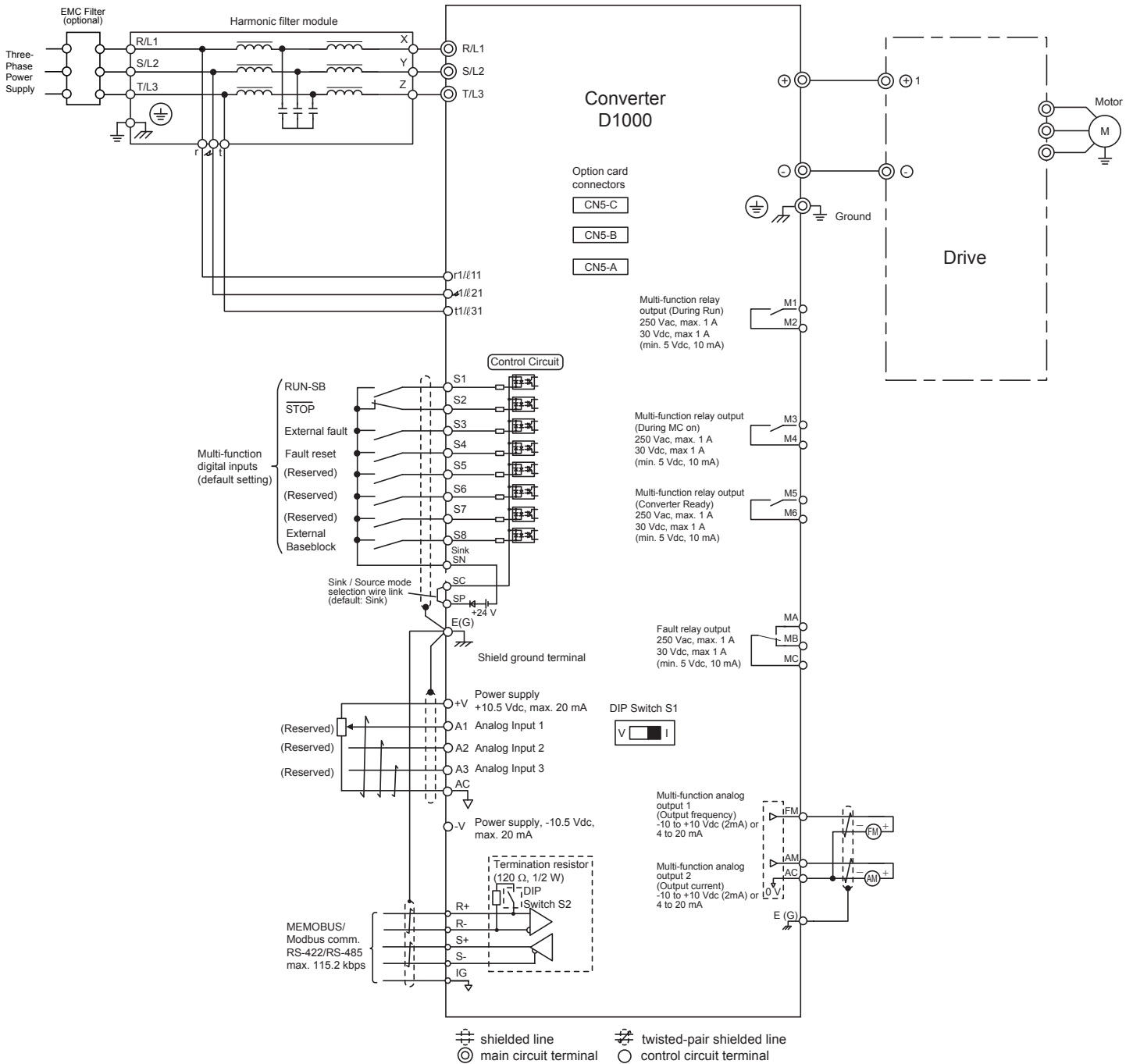

Dimensions for 200 V Models from 5 kW to 130 kW

Typical Connection Diagram

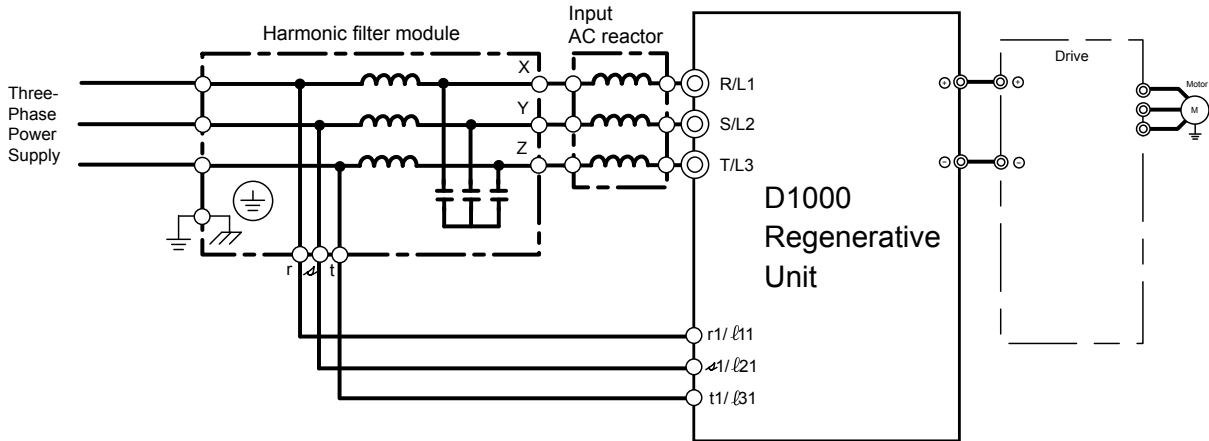

D1000 Regenerative Converter Unit - 200 V Class

Part Number Kit	Part Number	IP	Fig.	Dimensions [mm]								Weight [kg]	
				W	H	D	W1	H1	H2	D1	d		
D1KIT20005ABAAA	CIMR-DC2A0005BAA	20	1	180	300	187	160	284	8	75	M5	5	
D1KIT20010ABAAA	CIMR-DC2A0010BAA			220	365	197	192	335	8	78	M6	8	
D1KIT20020ABAAA	CIMR-DC2A0020BAA	00	1	275	450	258	220	435	7.5	100	M6	21	
D1KIT20030ABAAA	CIMR-DC2A0030AAA			325	550	283	260	535	7.5	110	M6	32	
D1KIT20050ABAAA	CIMR-DC2A0050AAA		2	2	450	705	330	325	680	12.5	130	M10	57
D1KIT20065ABAAA	CIMR-DC2A0065AAA				450	705	330	325	680	12.5	130	M10	61
D1KIT20090ABAAA	CIMR-DC2A0090AAA		3	3	500	800	350	370	773	13	130	M12	85
D1KIT20130ABAAA	CIMR-DC2A0130AAA				500	800	350	370	773	13	130	M12	85

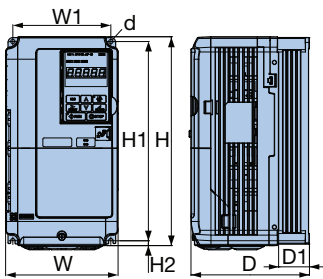

Figure 1

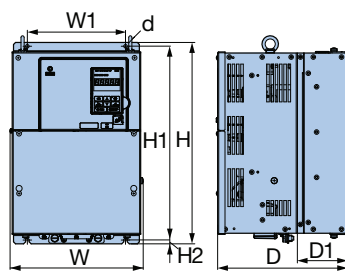

Figure 2

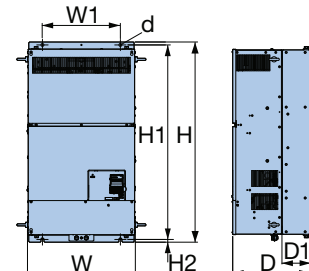

Figure 3

Dimensions for Package Components

AC Input Reactor 1 - 200 V Class

Part Number Kit	Part Number	QTY	Fig.	Dimensions [mm]						Weight [kg]	
				W	H	D	W1	d	d1		
D1KIT20005ABAAA	100-106-071	1	4	160	133	172	160	M6	M4	8.2	
D1KIT20010ABAAA	100-106-072			205	173	179	205	M6	M5	14	
D1KIT20020ABAAA	100-106-073			266	251	238	220	M8	M6	28	
D1KIT20030ABAAA	100-106-074			266	290	260	220	M8	M8	38	
D1KIT20050ABAAA	100-106-075		5	5	330	334	268	270	M10	M8	65
D1KIT20065ABAAA	100-106-076				320	343	306	270	M10	M12	79
D1KIT20090ABAAA	100-106-077				380	382	320	320	M12	M12	102
D1KIT20130ABAAA	100-106-078				445	436	386	420	M12	M12	164

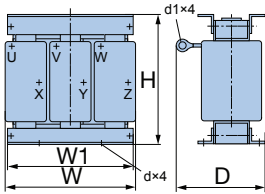

Figure 4*

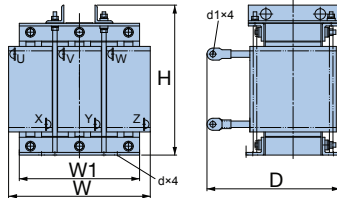

Figure 5*

Harmonic Filter Module - 200 V Class

Part Number Kit	Part Number	Fig.	Dimensions [mm]					Weight [kg]
			W	H	D	W1	d	
D1KIT20005ABAAA	EUJ710800.KM	6	209	176	285	160	M6	6.5
D1KIT20010ABAAA	EUJ710810.KM		209	184	295	160	M6	9
D1KIT20020ABAAA	EUJ710820.KM		232	265	301	203	M8	14
D1KIT20030ABAAA	EUJ710830.KM		260	281	305	220	M8	16
D1KIT20050ABAAA	EUJ710840.KM		290	348	355	250	M10	27
D1KIT20065ABAAA	EUJ710850.KM		290	350	352	254	M10	38
D1KIT20090ABAAA	EUJ710860.KM		290	387	352	254	M10	43
D1KIT20130ABAAA	EUJ710871.KM		350	500	380	290	M10	62

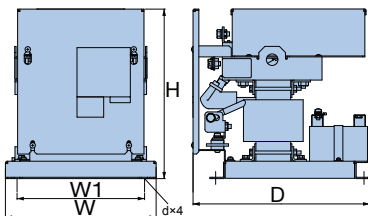

Figure 6*

* Appearance might change with capacity

Dimensions for 400 V Models from 5 kW to 40 kW

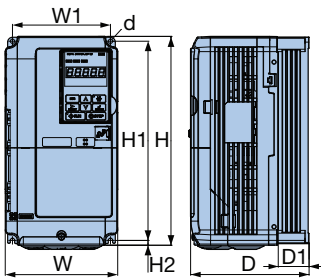

Figure 1

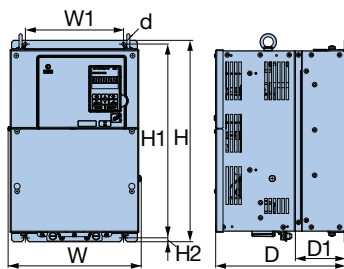

Figure 2

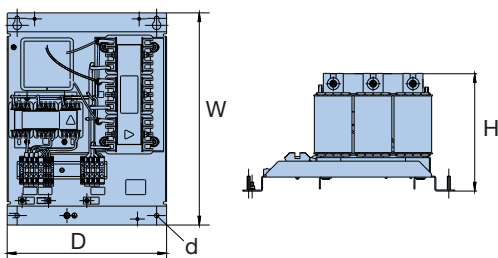

Figure 3*

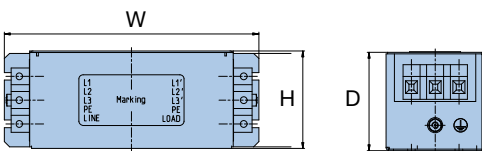

Figure 4*

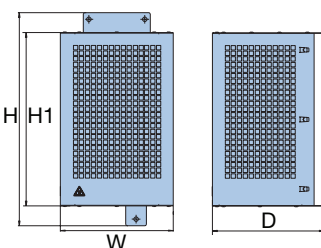
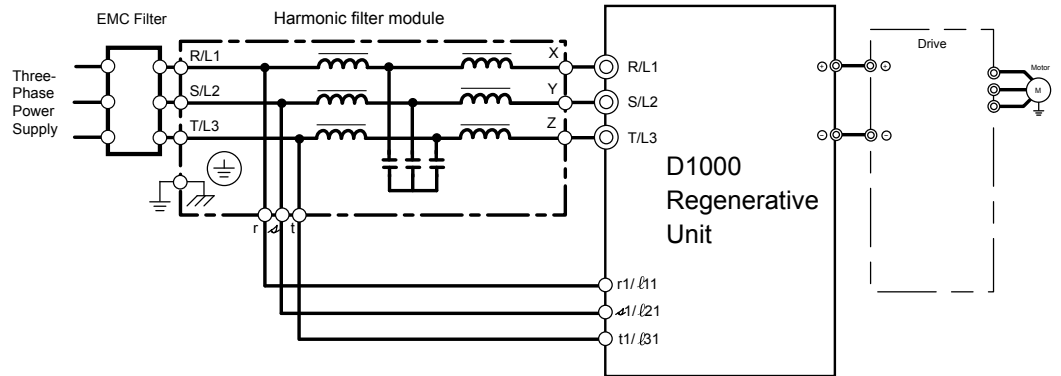

Figure 5*

Typical Connection Diagram



D1000 Regenerative Converter Unit 400 V

Part Number Kit	Part Number	IP	Fig.	Dimensions [mm]							Weight [kg]	
				W	H	D	W1	H1	H2	D1		d
D1KIT40005A□□AB	CIMR-DC4A0005BAA	20	1	180	300	187	160	284	8	75	M5	5
D1KIT40010A□□AB	CIMR-DC4A0010BAA			220	365	197	192	335	8	78	M6	8
D1KIT40020A□□AB	CIMR-DC4A0020BAA	00	2	275	450	258	220	435	7.5	100	M6	21
D1KIT40030A□□AB	CIMR-DC4A0030AAA											
D1KIT40040A□□AB	CIMR-DC4A0040AAA											

Harmonic Filter Module

Part Number Kit	Part Number	Fig.	Dimensions [mm]				Weight [kg]
			W	H	D	d	
D1KIT40005A□□AB	B84143G0008R176	3	386	176 ±5	200	Ø9	9
D1KIT40010A□□AB	B84143G0016R176		426	234 ±5	320		18
D1KIT40020A□□AB	B84143G0030R176		426	236 ±5	320		28
D1KIT40030A□□AB	B84143G0043R176		436	286 ±5	430	Ø9	37
D1KIT40040A□□AB	B84143G0058R176						64

EMC Filter (optional)

Part Number Kit	Part Number	Fig.	Dimensions [mm]			Weight [kg]
			W	H	D	
D1KIT40005A□□AB	B84143A0020R106	4	386	200	202	0.6
D1KIT40010A□□AB						
D1KIT40020A□□AB	B84143A0035R106		426	250	322	0.9
D1KIT40030A□□AB	B84143A0065R106		436	310	432	1.9
D1KIT40040A□□AB						

IP20 Cover (optional)

Part Number Kit	Part Number	Fig.	Dimensions [mm]				Weight [kg]
			W	H	D	H1	
D1KIT40005A□□BAB	B84143Q0008R176	5	202	386	200	314	1.5
D1KIT40010A□□BAB	B84143Q0016R176		322	426	250	354	2.5
D1KIT40020A□□BAB							
D1KIT40030A□□BAB	B84143Q0043R176		432	436	310	364	3.7
D1KIT40040A□□BAB							

* Appearance might change with capacity

Dimensions for 400 V Models from 60 kW to 100 kW

Typical Connection Diagram

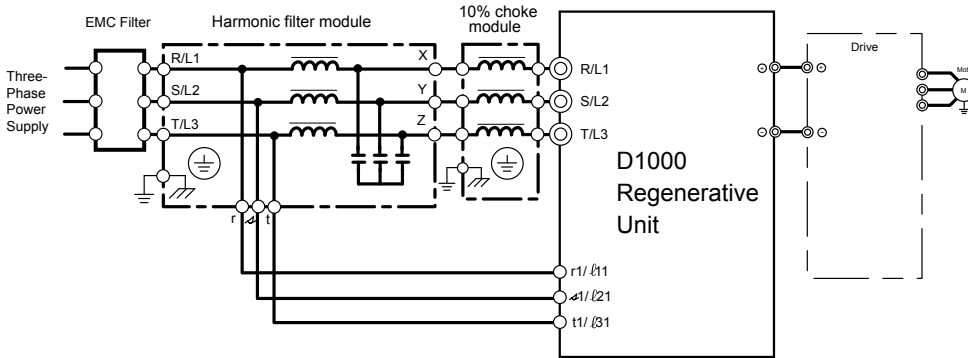

D1000 Regenerative Converter Unit 400 V

Part Number Kit	Part Number	IP	Fig.	Dimensions [mm]							Weight [kg]	
				W	H	D	W1	H1	H2	D1		d
D1KIT40060A□AAB	CIMR-DC4A0060AAA	00	1	325	550	283	260	535	7.5	110	M6	34
D1KIT40100A□AAB	CIMR-DC4A0100AAA			36								

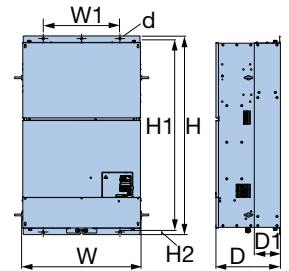

Figure 1

Harmonic Filter Module

Part Number Kit	Part Number	Fig.	Package Component Module	Dimensions [mm]				Weight [kg]
				W	H	D	d	
D1KIT40060A□AAB	B84143G0086R176	2	Harmonic Filter	265	288±5	240	Ø9	20
		3	10%-Choke	149	max. 390	300	Ø15x25	55
D1KIT40100A□AAB	B84143G0145R176	2	Harmonic Filter	328	303±5	240	Ø9	30
		4	10%-Choke	max. 390	max. 405	max. 365	Ø15x25	69

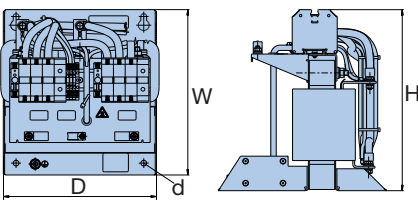

Figure 2*

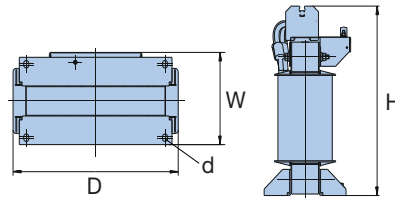

Figure 3

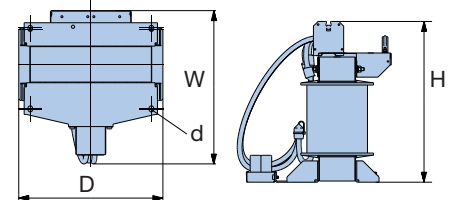

Figure 4

EMC Filter (optional)

Part Number Kit	Part Number	Fig.	Dimensions [mm]			Weight [kg]
			W	H	D	
D1KIT40060AAAAB	B84143B0180S080	5	200	170	110	5.0
D1KIT40100AAAAB						

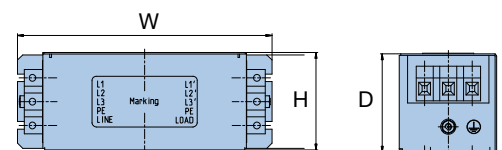

Figure 5

* Appearance might change with capacity

Dimensions for 400 V Models from 130 kW to 185 kW

Typical Connection Diagram

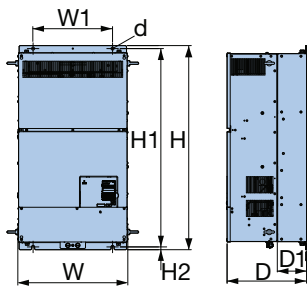
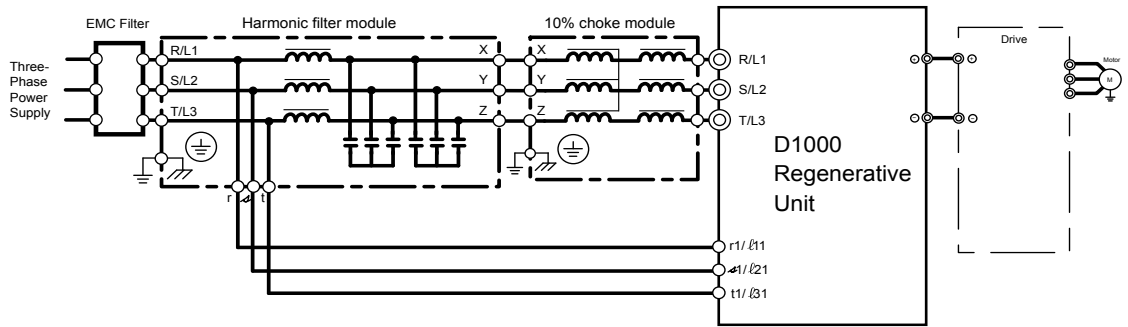

Figure 1

D1000 Regenerative Converter Unit 400 V

Part Number Kit	Part Number	IP	Fig.	Dimensions [mm]							Weight [kg]	
				W	H	D	W1	H1	H2	D1		
D1KIT40130A□AAB	CIMR-DC4A0130AAA	00	1	500	800	350	370	773	13	130	M12	85
D1KIT40185A□AAB	CIMR-DC4A0185AAA											

Harmonic Filter Module

Part Number Kit	Part Number	Fig.	Package Component Module	Dimensions [mm]			Weight [kg]
				W	H	D	
D1KIT40130A□AAB	B84143G0210S176	2	Harmonic Filter	206±3	438	300	39
			10%-Choke	max. 400	max. 445	max. 420	98
D1KIT40185A□AAB	B84143G0300S176	2	Harmonic Filter	216±3	437	300	42
			10%-Choke	max. 550	max. 490	max. 440	149

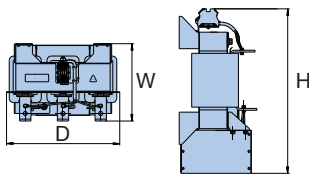

Figure 2*

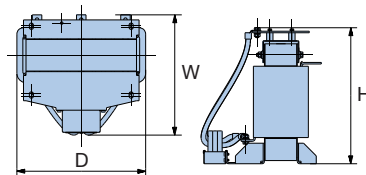

Figure 3

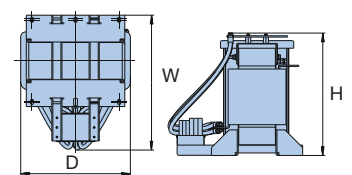

Figure 4

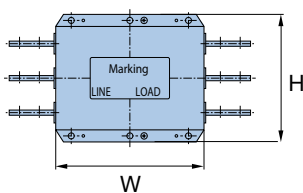

Figure 5

EMC Filter (optional)

Part Number Kit	Part Number	Fig.	Dimensions [mm]			Weight [kg]
			W	H	D	
D1KIT40130AAAAAB	B84143B0400S080	5	290	190	116	7.5
D1KIT40185AAAAAB						

* Appearance might change with capacity

Dimensions for 400 V Models with 270 kW

Typical Connection Diagram

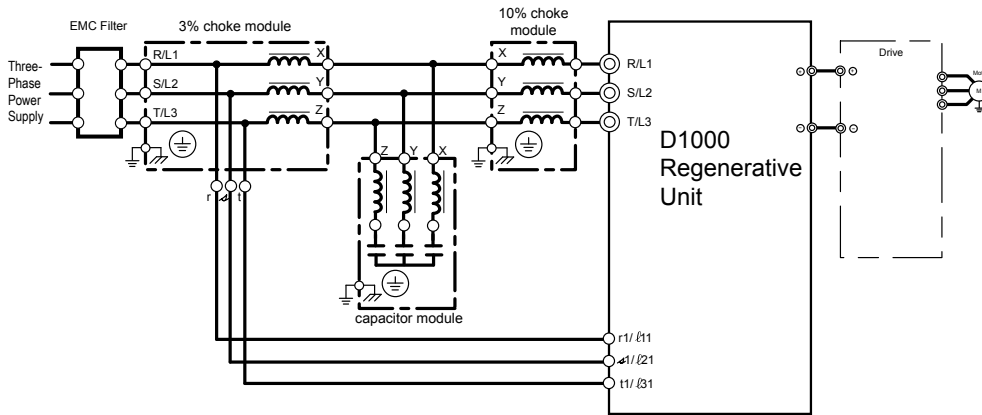

D1000 Regenerative Converter Unit 400 V

Part Number Kit	Part Number	IP	Fig.	Dimensions [mm]								Weight [kg]
				W	H	D	W1	H1	H2	D1	d	
D1KIT40270A□AAB	CIMR-DC4A0270AAA	00	1	370	1140	370	440	1100	15	150	M12	183

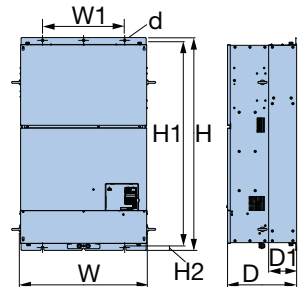

Figure 1

Harmonic Filter Module

Part Number Kit	Part Number	Fig.	Package Component Module	Dimensions [mm]			Weight [kg]
				W	H	D	
D1KIT40270A□AAB	B84143G0410S176	2	3%-Choke	218±3	440±2.5	300	45
		3	Capacitor	281	327	200	12
		4	10%-Choke	401	max. 450	430	163

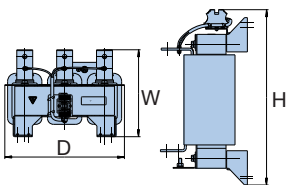

Figure 2

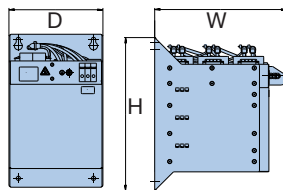

Figure 3

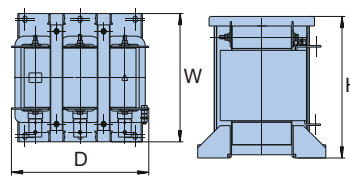

Figure 4

EMC Filter (optional)

Part Number Kit	Part Number	Fig.	Dimensions [mm]			Weight [kg]
			W	H	D	
D1KIT40270AAAAB	B84143B1000S080	5	300	260	140	18.5

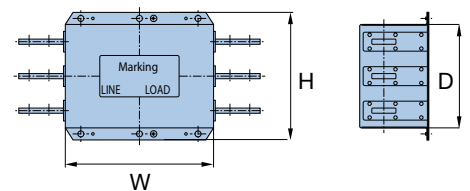
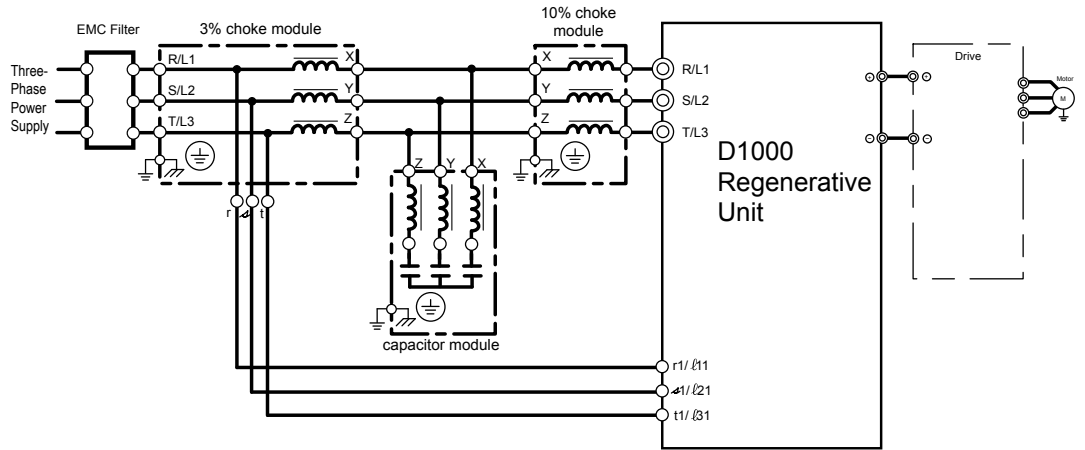

Figure 5

Dimensions for 400 V Models with 370 kW



D1000 Regenerative Converter Unit 400 V

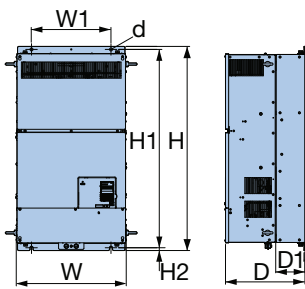

Figure 1

Part Number Kit	Part Number	IP	Fig.	Dimensions [mm]							Weight [kg]	
				W	H	D	W1	H1	H2	D1		d
D1KIT40370A□AAB	CIMR-DC4A0370AAA	00	1	370	1140	370	440	1100	15	150	M12	194

Harmonic Filter Module

Part Number Kit	Part Number	Fig.	Package Component Module	Dimensions [mm]			Weight [kg]
				W	H	D	
D1KIT40370A□AAB	B84143G0560S176	2	3%-Choke	243±3	430±2.5	300	55
		3	Capacitor	409	379	307	25
		4	10%-Choke	351±3	max. 590	max. 520	175

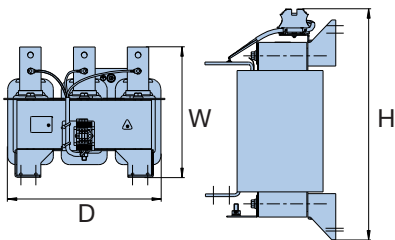

Figure 2

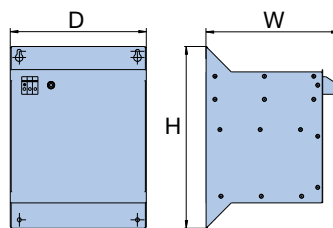

Figure 3

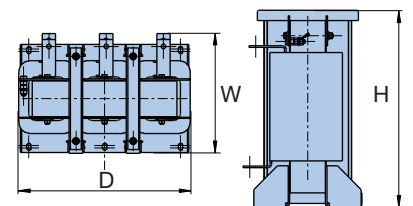

Figure 4

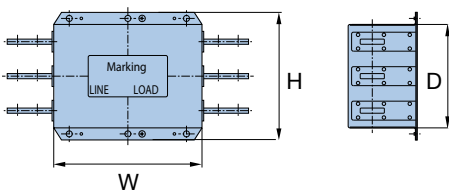
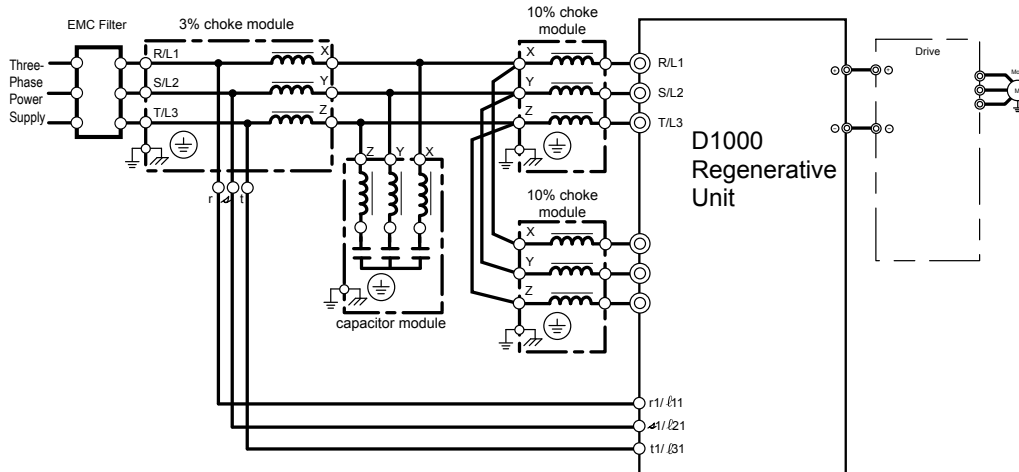

Figure 5

EMC Filter (optional)

Part Number Kit	Part Number	Fig.	Dimensions [mm]			Weight [kg]
			A	B	C	
D1KIT40370AAAAB	B84143B1000S080	5	300	260	140	18.5

Dimensions for 400 V Models with 630 kW



D1000 Regenerative Converter Unit 400 V

Part Number Kit	Part Number	IP	Fig.	Dimensions [mm]							Weight [kg]	
				W	H	D	W1	H1	H2	D1		d
D1KIT40630A□AAB	CIMR-DC4A0630AAA	00	1	1250	1380	370	1100	1345	15	150	M12	413

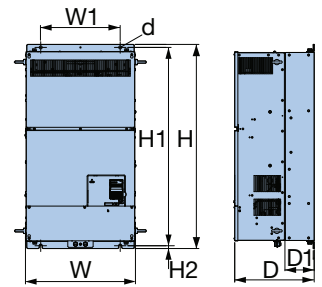

Figure 1

Harmonic Filter Module

Part Number Kit	Part Number	Fig.	Package Component Module	Dimensions [mm]			Weight [kg]
				W	H	D	
D1KIT40630A□AAB	B84143G1140S176	2	3%-Choke	277±3	634.5±2.5	300	90
		3	Capacitor	318	667	307	50
		4	10%-Choke x2	351±3	max. 590	max. 520	175 x2

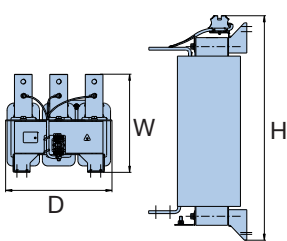

Figure 2

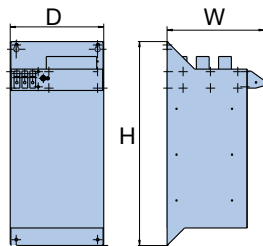

Figure 3

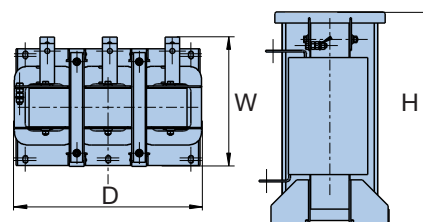

Figure 4

EMC Filter (optional)

Part Number Kit	Part Number	Fig.	Dimensions [mm]			Weight [kg]
			A	B	C	
D1KIT40630AAAAB	B84143B1600S080	5	300	260	210	24.5

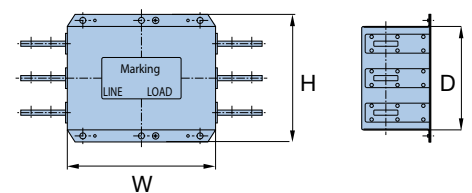

Figure 5



YASKAWA Europe GmbH

Drives & Motion Division
Hauptstr. 185
65760 Eschborn
Germany

Tel: +49 6196 569-500
support@yaskawa.eu.com
www.yaskawa.eu.com