

## $\Sigma$ -7-Series AC Servo Drive $\Sigma$ -7W SERVOPACK with MECHATROLINK-III Communications References RJ-45 Connectors Product Manual

Model: SGD7W-□□□□30A

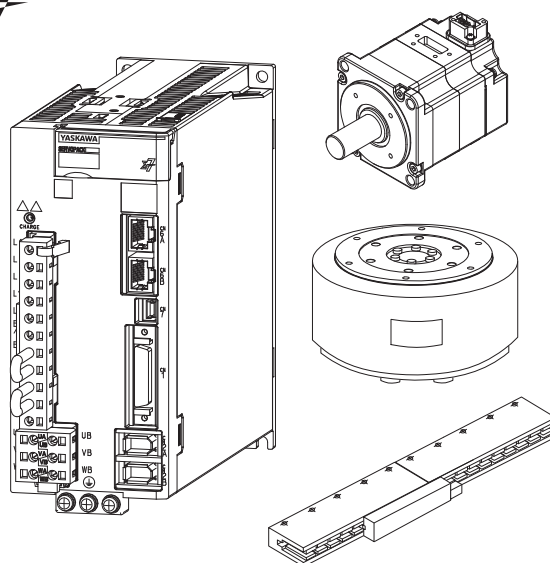

Basic Information on SERVOPACKs	1
Selecting a SERVOPACK	2
SERVOPACK Installation	3
Wiring and Connecting SERVOPACKs	4
Basic Functions That Require Setting before Operation	5
Application Functions	6
Trial Operation and Actual Operation	7
Tuning	8
Monitoring	9
Maintenance	10
Parameter Lists	11
Appendices	12

Copyright © 2014 YASKAWA ELECTRIC CORPORATION

---

All rights reserved. No part of this publication may be reproduced, stored in a retrieval system, or transmitted, in any form, or by any means, mechanical, electronic, photocopying, recording, or otherwise, without the prior written permission of Yaskawa. No patent liability is assumed with respect to the use of the information contained herein. Moreover, because Yaskawa is constantly striving to improve its high-quality products, the information contained in this manual is subject to change without notice. Every precaution has been taken in the preparation of this manual. Nevertheless, Yaskawa assumes no responsibility for errors or omissions. Neither is any liability assumed for damages resulting from the use of the information contained in this publication.

## About this Manual

This manual provides information required to select  $\Sigma$ -7W SERVOPACKs with MECHATROLINK-III Communications References and RJ-45 Connectors for  $\Sigma$ -7-Series AC Servo Drives, and to design, perform trial operation of, tune, operate, and maintain the Servo Drives.

Read and understand this manual to ensure correct usage of the  $\Sigma$ -7-Series AC Servo Drives.

Keep this manual in a safe place so that it can be referred to whenever necessary.

## Outline of Manual

The contents of the chapters of this manual are described in the following table.

Refer to these chapters as required.

Chapter	Chapter Title	Contents
1	Basic Information on SERVOPACKs	Provides information required to select SERVOPACKs, such as SERVOPACK models and combinations with Servomotors.
2	Selecting a SERVOPACK	Provides information required to select SERVOPACKs, such as specifications, block diagrams, dimensional drawings, and connection examples.
3	SERVOPACK Installation	Provides information on installing SERVOPACKs in the required locations.
4	Wiring and Connecting SERVOPACKs	Provides information on wiring and connecting SERVOPACKs to power supplies and peripheral devices.
5	Basic Functions That Require Setting before Operation	Describes the basic functions that must be set before you start servo system operation. It also describes the setting methods.
6	Application Functions	Describes the application functions that you can set before you start servo system operation. It also describes the setting methods.
7	Trial Operation and Actual Operation	Provides information on the flow and procedures for trial operation and convenient functions to use during trial operation.
8	Tuning	Provides information on the flow of tuning, details on tuning functions, and related operating procedures.
9	Monitoring	Provides information on monitoring SERVOPACK product information and SERVOPACK status.
10	Maintenance	Provides information on the meaning of, causes of, and corrections for alarms and warnings.
11	Parameter Lists	Provides information on the parameters.
12	Appendices	Provides information on interpreting panel displays and tables of corresponding SERVOPACK and SigmaWin+ function names.

# Related Documents

The relationships between the documents that are related to the Servo Drives are shown in the following figure. The numbers in the figure correspond to the numbers in the table on the following pages. Refer to these documents as required.

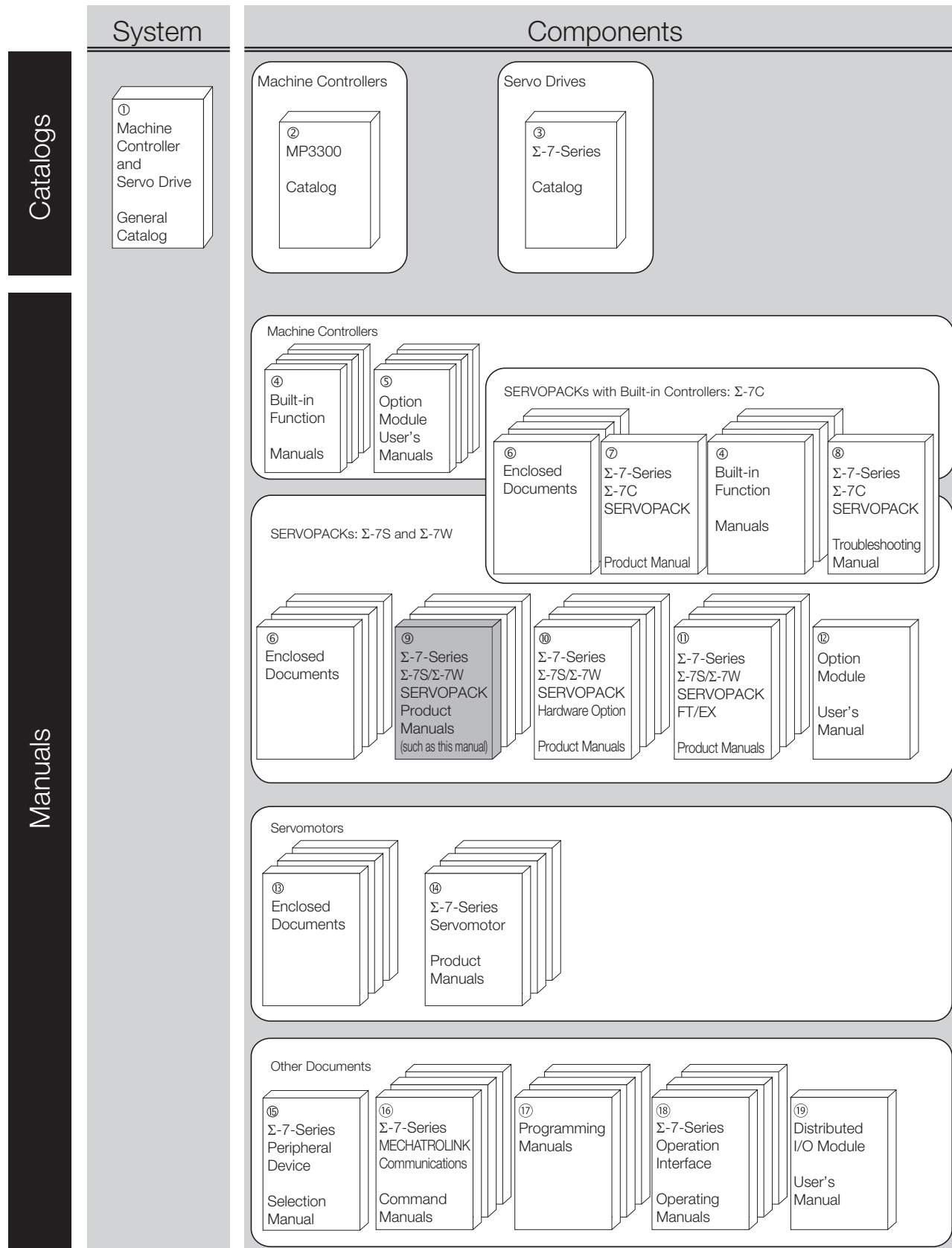

Classification	Document Name	Document No.	Description
① Machine Controller and Servo Drive General Catalog	Machine Controller and AC Servo Drive Solutions Catalog	KAEP S800001 22	Describes the features and application examples for combinations of MP3000-Series Machine Controllers and $\Sigma$ -7-Series AC Servo Drives.
② MP3300 Catalog	Machine Controller MP3300	KAEP C880725 03	Provides detailed information on MP3300 Machine Controllers, including features and specifications.
③ $\Sigma$ -7-Series Catalog	AC Servo Drives $\Sigma$ -7 Series	KAEP S800001 23	Provides detailed information on $\Sigma$ -7-Series AC Servo Drives, including features and specifications.
④ Built-in Function Manuals	$\Sigma$ -7-Series AC Servo Drive $\Sigma$ -7C SERVOPACK Motion Control User's Manual	SIEP S800002 03	Provides detailed information on the specifications, system configuration, and application methods of the Motion Control Function Modules (SVD, SVC4, and SVR4) for $\Sigma$ -7-Series $\Sigma$ -7C SERVOPACKs.
	Machine Controller MP3000 Series Communications User's Manual	SIEP C880725 12	Provides detailed information on the specifications, system configuration, and communications connection methods for the Ethernet communications that are used with MP3000-Series Machine Controllers and $\Sigma$ -7-Series $\Sigma$ -7C SERVOPACKs.
⑤ Option Module User's Manuals	Machine Controller MP2000 Series Communication Module User's Manual	SIEP C880700 04	Provide detailed information on the specifications and communications methods for the Communications Modules that can be mounted to MP3000-Series Machine Controllers and $\Sigma$ -7-Series $\Sigma$ -7C SERVOPACKs.
	Machine Controller MP2000 Series 262IF-01 FL-net Communication Module User's Manual	SIEP C880700 36	
	Machine Controller MP2000 Series 263IF-01 EtherNet/IP Communication Module User's Manual	SIEP C880700 39	
	Machine Controller MP2000 Series I/O Module User's Manual	SIEP C880700 34	Provide detailed information on the specifications and communications methods for the I/O Modules that can be mounted to MP3000-Series Machine Controllers and $\Sigma$ -7-Series $\Sigma$ -7C SERVOPACKs.
	Machine Controller MP2000 Series Analog Input/Analog Output Module AI-01/AO-01 User's Manual	SIEP C880700 26	
	Machine Controller MP2000 Series Counter Module CNTR-01 User's Manual	SIEP C880700 27	

Continued on next page.

Continued from previous page.

Classification	Document Name	Document No.	Description
⑥ Enclosed Documents	Σ-7-Series AC Servo Drive Σ-7S and Σ-7W SERVOPACK Safety Precautions	TOMP C710828 00	Provides detailed information for the safe usage of Σ-7-Series SERVOPACKS.
	Σ-V-Series/Σ-V-Series for Large-Capacity Models/ Σ-7-Series Safety Precautions Option Module	TOBP C720829 00	Provides detailed information for the safe usage of Option Modules.
	Σ-V-Series/Σ-V-Series for Large-Capacity Models/ Σ-7-Series Installation Guide Command Option Module	TOBP C720829 01	Provides detailed procedures for installing the Command Option Module in a SERVOPACK.
	Σ-V-Series/Σ-V-Series for Large-Capacity Models/ Σ-7-Series Installation Guide Fully-closed Module	TOBP C720829 03	Provides detailed procedures for installing the Fully-closed Module in a SERVOPACK.
	Σ-V-Series/Σ-V-Series for Large-Capacity Models/ Σ-7-Series Installation Guide Safety Module	TOBP C720829 06	Provides detailed procedures for installing the Safety Module in a SERVOPACK.
	Σ-V-Series/Σ-V-Series for Large-Capacity Models/ Σ-7-Series Installation Guide INDEXER Module	TOBP C720829 02	Provides detailed procedures for installing the INDEXER Module in a SERVOPACK.
	Σ-V-Series/Σ-V-Series for Large-Capacity Models/ Σ-7-Series Installation Guide DeviceNet Module	TOBP C720829 07	Provides detailed procedures for installing the DeviceNet Module in a SERVOPACK.
⑦ Σ-7-Series Σ-7C SERVOPACK Product Manual	Σ-7-Series AC Servo Drive Σ-7C SERVOPACK Product Manual	SIEP S800002 04	Provides detailed information on selecting Σ-7-Series Σ-7C SERVOPACKS; installing, connecting, setting, testing in trial operation, and tuning Servo Drives; writing, monitoring, and maintaining programs; and other information.
⑧ Σ-7-Series Σ-7C SERVOPACK Troubleshooting Manual	Σ-7-Series AC Servo Drive Σ-7C SERVOPACK Troubleshooting Manual	SIEP S800002 07	Provides detailed troubleshooting information for Σ-7-Series Σ-7C SERVOPACKS.

Continued on next page.

Continued from previous page.

Classification	Document Name	Document No.	Description
⑨ Σ-7-Series Σ-7S/Σ-7W SERVOPACK Product Manuals	Σ-7-Series AC Servo Drive Σ-7S SERVOPACK with MECHATROLINK-III Communications References Product Manual	SIEP S800001 28	Provide detailed information on selecting Σ-7-Series Σ-7S and Σ-7W SERVOPACKs; installing, connecting, setting, testing in trial operation, tuning, monitoring, and maintaining Servo Drives; and other information.
	Σ-7-Series AC Servo Drive Σ-7S SERVOPACK with MECHATROLINK-II Communications References Product Manual	SIEP S800001 27	
	Σ-7-Series AC Servo Drive Σ-7S SERVOPACK with Analog Voltage/Pulse Train References Product Manual	SIEP S800001 26	
	Σ-7-Series AC Servo Drive Σ-7S SERVOPACK Command Option Attachable Type with INDEXER Module Product Manual	SIEP S800001 64	
	Σ-7-Series AC Servo Drive Σ-7S SERVOPACK Command Option Attachable Type with DeviceNet Module Product Manual	SIEP S800001 70	
	Σ-7-Series AC Servo Drive Σ-7S SERVOPACK with MECHATROLINK-III Communications References RJ-45 Connectors Product Manual	SIEP S800001 62	
	Σ-7-Series AC Servo Drive Σ-7W SERVOPACK with MECHATROLINK-III Communications References Product Manual	SIEP S800001 29	
	Σ-7-Series AC Servo Drive Σ-7W SERVOPACK with MECHATROLINK-III Communications References RJ-45 Connectors Product Manual	This manual (SIEP S800001 63)	
⑩ Σ-7-Series Σ-7S/Σ-7W SERVOPACK with Hardware Option Specifications Product Manuals	Σ-7-Series AC Servo Drive Σ-7S/Σ-7W SERVOPACK with Hardware Option Specifica- tions Dynamic Brake Product Manual	SIEP S800001 73	Provide detailed information on Hardware Options for Σ-7-Series SERVOPACKs.
	Σ-7-Series AC Servo Drive Σ-7W/Σ-7C SERVOPACK with Hardware Option Specifica- tions HWBB Function Product Manual	SIEP S800001 72	

Continued on next page.

Continued from previous page.

Classification	Document Name	Document No.	Description
⑩ Σ-7-Series Σ-7S/Σ-7W SERVOPACK FT/EX Product Manuals	Σ-7-Series AC Servo Drive Σ-7S SERVOPACK with FT/EX Specification for Index- ing Application Product Manual	SIEP S800001 84	Provide detailed information on the FT/EX Option for Σ-7-Series SERVOPACKs.
	Σ-7-Series AC Servo Drive Σ-7S SERVOPACK with FT/EX Specification for Track- ing Application Product Manual	SIEP S800001 89	
	Σ-7-Series AC Servo Drive Σ-7S SERVOPACK with FT/EX Specification for Application with Special Motor, SGM7D Motor Product Manual	SIEP S800001 91	
	Σ-7-Series AC Servo Drive Σ-7S SERVOPACK with FT/EX Specification for Press and injection Molding Application Product Manual	SIEP S800001 94	
	Σ-7-Series AC Servo Drive Σ-7S SERVOPACK with FT/EX Specification for Transfer and Alignment Application Product Manual	SIEP S800001 95	
	Σ-7-Series AC Servo Drive Σ-7S SERVOPACK with FT/EX Specification for Torque/Force Assistance for Conveyance Application Product Manual	SIEP S800002 09	
	Σ-7-Series AC Servo Drive Σ-7S SERVOPACK with FT/EX Specification for Cutting Application Feed Shaft Motor Product Manual	SIEP S800002 10	
	Σ-7-Series AC Servo Drive Σ-7S SERVOPACK with FT/EX Specification for Three-Point Latching for Conveyance Application Product Manual	SIEP S800002 17	
	Σ-7-Series AC Servo Drive Σ-7S SERVOPACK with FT/EX Specification for Semi-/Fully-Closed Loop Control Online Switching for Conveyance Application Product Manual	SIEP S800002 27	
	Σ-7-Series AC Servo Drive Σ-7W SERVOPACK with FT/EX Specification for Gantry Applications Product Manual	SIEP S800002 29	

Continued on next page.



Continued from previous page.

Classification	Document Name	Document No.	Description
⑩ Option Module User's Manual	AC Servo Drives $\Sigma$ -V Series/ $\Sigma$ -V Series for Large-Capacity Models/ $\Sigma$ -7 Series User's Manual Safety Module	SIEP C720829 06	Provides detailed information required for the design and mainte- nance of a Safety Module.
⑩ Enclosed Documents	AC Servo Drive Rotary Servomotor Safety Precautions	TOBP C230260 00	Provides detailed information for the safe usage of Rotary Servomo- tors and Direct Drive Servomotors.
	AC Servomotor Linear $\Sigma$ Series Safety Precautions	TOBP C230800 00	Provides detailed information for the safe usage of Linear Servomo- tors.
⑩ $\Sigma$ -7-Series Servomotor Product Manuals	$\Sigma$ -7-Series AC Servo Drive Rotary Servomotor Product Manual	SIEP S800001 36	Provide detailed information on selecting, installing, and connecting the $\Sigma$ -7-Series Servomotors.
	$\Sigma$ -7-Series AC Servo Drive Linear Servomotor Product Manual	SIEP S800001 37	
	$\Sigma$ -7-Series AC Servo Drive Direct Drive Servomotor Product Manual	SIEP S800001 38	
⑩ $\Sigma$ -7-Series Peripheral Device Selection Manual	$\Sigma$ -7-Series AC Servo Drive Peripheral Device Selection Manual	SIEP S800001 32	Provides the following information in detail for $\Sigma$ -7-Series Servo Sys- tems. • Cables: Models, dimensions, wir- ing materials, connector models, and connection specifications • Peripheral devices: Models, specifications, diagrams, and selection (calculation) methods
⑩ $\Sigma$ -7-Series MECHATROLINK Communications Command Manuals	$\Sigma$ -7-Series AC Servo Drive MECHATROLINK-II Communications Command Manual	SIEP S800001 30	Provides detailed information on the MECHATROLINK-II communi- cations commands that are used for a $\Sigma$ -7-Series Servo System.
	$\Sigma$ -7-Series AC Servo Drive MECHATROLINK-III Communications Standard Servo Profile Command Manual	SIEP S800001 31	Provides detailed information on the MECHATROLINK-III communi- cations standard servo profile com- mands that are used for a $\Sigma$ -7- Series Servo System.
⑩ Programming Manuals	Machine Controller MP3000 Series Ladder Programming Manual	SIEP C880725 13	Provides detailed information on the ladder programming specifica- tions and instructions for MP3000- Series Machine Controllers and $\Sigma$ - 7-Series $\Sigma$ -7C SERVOPACKs.
	Machine Controller MP3000 Series Motion Programming Manual	SIEP C880725 14	Provides detailed information on the motion programming and sequence programming specifica- tions and instructions for MP3000- Series Machine Controllers and $\Sigma$ - 7-Series $\Sigma$ -7C SERVOPACKs.
⑩ $\Sigma$ -7-Series Operation Interface Operating Manuals	Machine Controller MP2000/MP3000 Series Engineering Tool MPE720 Version 7 User's Manual	SIEP C880761 03	Describes in detail how to operate MPE720 version 7.
	$\Sigma$ -7-Series AC Servo Drive Digital Operator Operating Manual	SIEP S800001 33	Describes the operating proce- dures for a Digital Operator for a $\Sigma$ -7-Series Servo System.
	AC Servo Drive Engineering Tool SigmaWin+ Operation Manual	SIET S800001 34	Provides detailed operating proce- dures for the SigmaWin+ Engineer- ing Tool for a $\Sigma$ -7-Series Servo System.
⑩ Distributed I/O Module User's Manual	MECHATROLINK-III Compatible I/O Module User's Manual	SIEP C880781 04	Describes the functions, specifica- tions, operating methods, and MECHATROLINK-III communi- cations for the Remote I/O Modules for MP2000/MP3000-Series Machine Controllers.

# Using This Manual

## ◆ Technical Terms Used in This Manual

The following terms are used in this manual.

Term	Meaning
Servomotor	A $\Sigma$ -7-Series Rotary Servomotor, Direct Drive Servomotor, or Linear Servomotor.
Rotary Servomotor	A generic term used for a $\Sigma$ -7-Series Rotary Servomotor (SGM7M, SGM7J, SGM7A, SGM7P, SGM7G, or SGM7V) or a Direct Drive Servomotor (SGM7E, SGM7F, SGM7C, or SGM7S). The descriptions will specify when Direct Drive Servomotors are excluded.
Linear Servomotor	A $\Sigma$ -7-Series Linear Servomotor (SGLG, SGLF, or SGLT).
SERVOPACK	A $\Sigma$ -7-Series $\Sigma$ -7W Servo Amplifier with MECHATROLINK-III Communications References.
Servo Drive	The combination of a Servomotor and SERVOPACK.
Servo System	A servo control system that includes the combination of a Servo Drive with a host controller and peripheral devices.
servo ON	Supplying power to the motor.
servo OFF	Not supplying power to the motor.
base block (BB)	Shutting OFF the power supply to the motor by shutting OFF the base current to the power transistor in the SERVOPACK.
servo lock	A state in which the motor is stopped and is in a position loop with a position reference of 0.
Main Circuit Cable	One of the cables that connect to the main circuit terminals, including the Main Circuit Power Supply Cable, Control Power Supply Cable, and Servomotor Main Circuit Cable.
MECHATROLINK-III Communications Cable (RJ-45)	MECHATROLINK-III Communications Cable for RJ-45 connectors.
SigmaWin+	The Engineering Tool for setting up and tuning Servo Drives or a computer in which the Engineering Tool is installed.

## ◆ Differences in Terms for Rotary Servomotors and Linear Servomotors

There are differences in the terms that are used for Rotary Servomotors and Linear Servomotors. This manual primarily describes Rotary Servomotors. If you are using a Linear Servomotor, you need to interpret the terms as given in the following table.

Rotary Servomotors	Linear Servomotors
torque	force
moment of inertia	mass
rotation	movement
forward rotation and reverse rotation	forward movement and reverse movement
CW and CCW pulse trains	forward and reverse pulse trains
rotary encoder	linear encoder
absolute rotary encoder	absolute linear encoder
incremental rotary encoder	incremental linear encoder
unit: $\text{min}^{-1}$	unit: $\text{mm/s}$
unit: $\text{N}\cdot\text{m}$	unit: $\text{N}$

## ◆ Notation Used in this Manual

### ■ Notation for Reverse Signals

The names of reverse signals (i.e., ones that are valid when low) are written with a forward slash (/) before the signal abbreviation.

Notation Example

$\overline{BK}$  is written as /BK.

### ■ Notation for Parameters

The notation depends on whether the parameter requires a numeric setting (parameter for numeric setting) or requires the selection of a function (parameter for selecting functions).

#### • Parameters for Numeric Settings

The control methods for which the parameters apply are given.  
Speed : Speed control Position : Position control Torque : Torque control

Pn100	Speed Loop Gain				<span>Speed</span> <span>Position</span>
	Setting Range	Setting Unit	Default Setting	When Enabled	Classification
	10 to 20,000	0.1 Hz	400	Immediately	Tuning

If All Axes is given here, the parameter applies to both axes A and B. If you change the setting, the new setting will be applied to both axes.

This is the minimum unit (setting increment) that you can set for the parameter.

This is the parameter setting before shipment.

This is when any change made to the parameter will become effective.

This is the parameter classification.

This is the setting range for the parameter.

#### • Parameters for Selecting Functions

Parameter	Meaning	When Enabled	Classification
Pn00F <span>All Axes</span>	n.□□□0 (default setting)	After restart	Setup
	n.□□□1		

The notation "n.□□□□" indicates a parameter for selecting functions. Each □ indicates the setting for one digit. The notation shown here means that the first digit from the right is set to 1.

This column explains the selections for the function.

If All Axes is given here, the parameter applies to both axes A and B. If you change the setting, the new setting will be applied to both axes.

#### Notation Example

Notation Examples for Pn002

n . 0 0 0 0	Digit Notation		Numeric Value Notation	
	Notation	Meaning	Notation	Meaning
→	Pn002 = n.□□□X	Indicates the first digit from the right in Pn002.	Pn002 = n.□□□1	Indicates that the first digit from the right in Pn002 is set to 1.
→	Pn002 = n.□□X□	Indicates the second digit from the right in Pn002.	Pn002 = n.□□1□	Indicates that the second digit from the right in Pn002 is set to 1.
→	Pn002 = n.□X□□	Indicates the third digit from the right in Pn002.	Pn002 = n.□1□□	Indicates that the third digit from the right in Pn002 is set to 1.
→	Pn002 = n.X□□□	Indicates the fourth digit from the right in Pn002.	Pn002 = n.1□□□	Indicates that the fourth digit from the right in Pn002 is set to 1.

---

## ◆ Engineering Tools Used in This Manual

This manual uses the interfaces of the SigmaWin+ for descriptions.

## ◆ Trademarks

- QR code is a trademark of Denso Wave Inc.
- MECHATROLINK is a trademark of the MECHATROLINK Members Association.
- Other product names and company names are the trademarks or registered trademarks of the respective company. “TM” and the ® mark do not appear with product or company names in this manual.

## ◆ Visual Aids

The following aids are used to indicate certain types of information for easier reference.



Indicates precautions or restrictions that must be observed.  
Also indicates alarm displays and other precautions that will not result in machine damage.



Indicates definitions of difficult terms or terms that have not been previously explained in this manual.

**Example** Indicates operating or setting examples.

**Information** Indicates supplemental information to deepen understanding or useful information.

---

# Safety Precautions

## ◆ Safety Information

To prevent personal injury and equipment damage in advance, the following signal words are used to indicate safety precautions in this document. The signal words are used to classify the hazards and the degree of damage or injury that may occur if a product is used incorrectly. Information marked as shown below is important for safety. Always read this information and heed the precautions that are provided.



### DANGER

- Indicates precautions that, if not heeded, are likely to result in loss of life, serious injury, or fire.



### WARNING

- Indicates precautions that, if not heeded, could result in loss of life, serious injury, or fire.



### CAUTION

- Indicates precautions that, if not heeded, could result in relatively serious or minor injury, or in fire.

### NOTICE

- Indicates precautions that, if not heeded, could result in property damage.

## ◆ Safety Precautions That Must Always Be Observed

### ■ General Precautions



## DANGER

- Read and understand this manual to ensure the safe usage of the product.
- Keep this manual in a safe, convenient place so that it can be referred to whenever necessary. Make sure that it is delivered to the final user of the product.
- Do not remove covers, cables, connectors, or optional devices while power is being supplied to the SERVOPACK.  
There is a risk of electric shock, operational failure of the product, or burning.



## WARNING

- Use a power supply with specifications (number of phases, voltage, frequency, and AC/DC type) that are appropriate for the product.  
There is a risk of burning, electric shock, or fire.
- Connect the ground terminals on the SERVOPACK and Servomotor to ground poles according to local electrical codes (100  $\Omega$  or less for a SERVOPACK with a 100-VAC or 200-VAC power supply, and 10  $\Omega$  or less for a SERVOPACK with a 400-VAC power supply).  
There is a risk of electric shock or fire.
- Do not attempt to disassemble, repair, or modify the product.  
There is a risk of fire or failure.  
The warranty is void for the product if you disassemble, repair, or modify it.



## CAUTION

- The SERVOPACK heat sinks, regenerative resistors, External Dynamic Brake Resistors, Servomotors, and other components can be very hot while power is ON or soon after the power is turned OFF. Implement safety measures, such as installing covers, so that hands and parts such as cables do not come into contact with hot components.  
There is a risk of burn injury.
- For a 24-VDC power supply, use a power supply device with double insulation or reinforced insulation.  
There is a risk of electric shock.
- Do not damage, pull on, apply excessive force to, place heavy objects on, or pinch cables.  
There is a risk of failure, damage, or electric shock.
- Do not use the product in an environment that is subject to water, corrosive gases, or flammable gases, or near flammable materials.  
There is a risk of electric shock or fire.

## NOTICE

- Do not attempt to use a SERVOPACK or Servomotor that is damaged or that has missing parts.
- Install external emergency stop circuits that shut OFF the power supply and stops operation immediately when an error occurs.
- In locations with poor power supply conditions, install the necessary protective devices (such as AC reactors) to ensure that the input power is supplied within the specified voltage range.  
There is a risk of damage to the SERVOPACK.
- Use a Noise Filter to minimize the effects of electromagnetic interference.  
Electronic devices used near the SERVOPACK may be affected by electromagnetic interference.
- Always use a Servomotor and SERVOPACK in one of the specified combinations.
- Do not touch a SERVOPACK or Servomotor with wet hands.  
There is a risk of product failure.

## ■ Storage Precautions

### CAUTION

- Do not place an excessive load on the product during storage. (Follow all instructions on the packages.)  
There is a risk of injury or damage.

### NOTICE

- Do not install or store the product in any of the following locations.
  - Locations that are subject to direct sunlight
  - Locations that are subject to ambient temperatures that exceed product specifications
  - Locations that are subject to relative humidities that exceed product specifications
  - Locations that are subject to condensation as the result of extreme changes in temperature
  - Locations that are subject to corrosive or flammable gases
  - Locations that are near flammable materials
  - Locations that are subject to dust, salts, or iron powder
  - Locations that are subject to water, oil, or chemicals
  - Locations that are subject to vibration or shock that exceeds product specifications
  - Locations that are subject to radiationIf you store or install the product in any of the above locations, the product may fail or be damaged.

## ■ Transportation Precautions

### CAUTION

- Transport the product in a way that is suitable to the mass of the product.
- Do not use the eyebolts on a SERVOPACK or Servomotor to move the machine.  
There is a risk of damage or injury.
- When you handle a SERVOPACK or Servomotor, be careful of sharp parts, such as the corners.  
There is a risk of injury.
- Do not place an excessive load on the product during transportation. (Follow all instructions on the packages.)  
There is a risk of injury or damage.

### NOTICE

- Do not hold onto the front cover or connectors when you move a SERVOPACK.  
There is a risk of the SERVOPACK falling.
- A SERVOPACK or Servomotor is a precision device. Do not drop it or subject it to strong shock.  
There is a risk of failure or damage.
- Do not subject connectors to shock.  
There is a risk of faulty connections or damage.
- If disinfectants or insecticides must be used to treat packing materials such as wooden frames, plywood, or pallets, the packing materials must be treated before the product is packaged, and methods other than fumigation must be used.  
Example: Heat treatment, where materials are kiln-dried to a core temperature of 56°C for 30 minutes or more.  
  
If the electronic products, which include stand-alone products and products installed in machines, are packed with fumigated wooden materials, the electrical components may be greatly damaged by the gases or fumes resulting from the fumigation process. In particular, disinfectants containing halogen, which includes chlorine, fluorine, bromine, or iodine can contribute to the erosion of the capacitors.
- Do not overtighten the eyebolts on a SERVOPACK or Servomotor.  
If you use a tool to overtighten the eyebolts, the tapped holes may be damaged.

## ■ Installation Precautions



### CAUTION

- Install the Servomotor or SERVOPACK in a way that will support the mass given in technical documents.
- Install SERVOPACKs, Servomotors, regenerative resistors, and External Dynamic Brake Resistors on nonflammable materials.  
Installation directly onto or near flammable materials may result in fire.
- Provide the specified clearances between the SERVOPACK and the control panel as well as with other devices.  
There is a risk of fire or failure.
- Install the SERVOPACK in the specified orientation.  
There is a risk of fire or failure.
- Do not step on or place a heavy object on the product.  
There is a risk of failure, damage, or injury.
- Do not allow any foreign matter to enter the SERVOPACK or Servomotor.  
There is a risk of failure or fire.

### NOTICE

- Do not install or store the product in any of the following locations.
  - Locations that are subject to direct sunlight
  - Locations that are subject to ambient temperatures that exceed product specifications
  - Locations that are subject to relative humidities that exceed product specifications
  - Locations that are subject to condensation as the result of extreme changes in temperature
  - Locations that are subject to corrosive or flammable gases
  - Locations that are near flammable materials
  - Locations that are subject to dust, salts, or iron powder
  - Locations that are subject to water, oil, or chemicals
  - Locations that are subject to vibration or shock that exceeds product specifications
  - Locations that are subject to radiationIf you store or install the product in any of the above locations, the product may fail or be damaged.
- Use the product in an environment that is appropriate for the product specifications.  
If you use the product in an environment that exceeds product specifications, the product may fail or be damaged.
- A SERVOPACK or Servomotor is a precision device. Do not drop it or subject it to strong shock.  
There is a risk of failure or damage.
- Always install a SERVOPACK in a control panel.
- Do not allow any foreign matter to enter a SERVOPACK or a Servomotor with a Cooling Fan and do not cover the outlet from the Servomotor's cooling fan.  
There is a risk of failure.

## ■ Wiring Precautions



### DANGER

- Do not change any wiring while power is being supplied.  
There is a risk of electric shock or injury.





## WARNING

- **Wiring and inspections must be performed only by qualified engineers.**  
There is a risk of electric shock or product failure.
- **Check all wiring and power supplies carefully.**  
Incorrect wiring or incorrect voltage application to the output circuits may cause short-circuit failures. If a short-circuit failure occurs as a result of any of these causes, the holding brake will not work. This could damage the machine or cause an accident that may result in death or injury.
- **Connect the AC and DC power supplies to the specified SERVOPACK terminals.**
  - Connect an AC power supply to the L1, L2, and L3 terminals and the L1C and L2C terminals on the SERVOPACK.
  - Connect a DC power supply to the B1/⊕ and ⊖2 terminals and the L1C and L2C terminals on the SERVOPACK.  
There is a risk of failure or fire.
- **If you use a SERVOPACK with the Dynamic Brake Hardware Option, connect an External Dynamic Brake Resistor that is suitable for the machine and equipment specifications to the specified terminals.**  
There is a risk of unexpected operation, machine damage, burning, or injury when an emergency stop is performed.



## CAUTION

- **Wait for six minutes after turning OFF the power supply and then make sure that the CHARGE indicator is not lit before starting wiring or inspection work. Do not touch the power supply terminals while the CHARGE lamp is lit after turning OFF the power supply because high voltage may still remain in the SERVOPACK.**  
There is a risk of electric shock.
- **Observe the precautions and instructions for wiring and trial operation precisely as described in this document.**  
Failures caused by incorrect wiring or incorrect voltage application in the brake circuit may cause the SERVOPACK to fail, damage the equipment, or cause an accident resulting in death or injury.
- **Check the wiring to be sure it has been performed correctly.**  
Connectors and pin layouts are sometimes different for different models. Always confirm the pin layouts in technical documents for your model before operation.  
There is a risk of failure or malfunction.
- **Connect wires to power supply terminals and motor connection terminals securely with the specified methods and tightening torque.**  
Insufficient tightening may cause wires and terminal blocks to generate heat due to faulty contact, possibly resulting in fire.
- **Use shielded twisted-pair cables or screened unshielded multi-twisted-pair cables for I/O Signal Cables and Encoder Cables.**
- **Observe the following precautions when wiring the SERVOPACK's main circuit terminals.**
  - Turn ON the power supply to the SERVOPACK only after all wiring, including the main circuit terminals, has been completed.
  - If a connector is used for the main circuit terminals, remove the main circuit connector from the SERVOPACK before you wire it.
  - Insert only one wire per insertion hole in the main circuit terminals.
  - When you insert a wire, make sure that the conductor wire (e.g., whiskers) does not come into contact with adjacent wires.
- **Install molded-case circuit breakers and other safety measures to provide protection against short circuits in external wiring.**  
There is a risk of fire or failure.

## NOTICE

- Whenever possible, use the Cables specified by Yaskawa.  
If you use any other cables, confirm the rated current and application environment of your model and use the wiring materials specified by Yaskawa or equivalent materials.
- Securely tighten cable connector screws and lock mechanisms.  
Insufficient tightening may result in cable connectors falling off during operation.
- Do not bundle power lines (e.g., the Main Circuit Cable) and low-current lines (e.g., the I/O Signal Cables or Encoder Cables) together or run them through the same duct. If you do not place power lines and low-current lines in separate ducts, separate them by at least 30 cm.  
If the cables are too close to each other, malfunctions may occur due to noise affecting the low-current lines.
- Install a battery at either the host controller or on the Encoder Cable.  
If you install batteries both at the host controller and on the Encoder Cable at the same time, you will create a loop circuit between the batteries, resulting in a risk of damage or burning.
- When connecting a battery, connect the polarity correctly.  
There is a risk of battery rupture or encoder failure.

### ■ Operation Precautions



## WARNING

- Before starting operation with a machine connected, change the settings of the switches and parameters to match the machine.  
Unexpected machine operation, failure, or personal injury may occur if operation is started before appropriate settings are made.
- Do not radically change the settings of the parameters.  
There is a risk of unstable operation, machine damage, or injury.
- Install limit switches or stoppers at the ends of the moving parts of the machine to prevent unexpected accidents.  
There is a risk of machine damage or injury.
- For trial operation, securely mount the Servomotor and disconnect it from the machine.  
There is a risk of injury.
- Forcing the motor to stop for overtravel is disabled when the Jog, Origin Search, or Easy FFT utility function is executed. Take necessary precautions.  
There is a risk of machine damage or injury.
- When an alarm occurs, the Servomotor will coast to a stop or stop with the dynamic brake according to the SERVOPACK option specifications and settings. The coasting distance will change with the moment of inertia of the load and the resistance of the External Dynamic Brake Resistor. Check the coasting distance during trial operation and implement suitable safety measures on the machine.
- Do not enter the machine's range of motion during operation.  
There is a risk of injury.
- Do not touch the moving parts of the Servomotor or machine during operation.  
There is a risk of injury.



## CAUTION

- Design the system to ensure safety even when problems, such as broken signal lines, occur. For example, the P-OT and N-OT signals are set in the default settings to operate on the safe side if a signal line breaks. Do not change the polarity of this type of signal.
- When overtravel occurs, the power supply to the motor is turned OFF and the brake is released. If you use the Servomotor to drive a vertical load, set the Servomotor to enter a zero-clamped state after the Servomotor stops. Also, install safety devices (such as an external brake or counterweight) to prevent the moving parts of the machine from falling.
- Always turn OFF the servo before you turn OFF the power supply. If you turn OFF the main circuit power supply or control power supply during operation before you turn OFF the servo, the Servomotor will stop as follows:
  - If you turn OFF the main circuit power supply during operation without turning OFF the servo, the Servomotor will stop abruptly with the dynamic brake.
  - If you turn OFF the control power supply without turning OFF the servo, the stopping method that is used by the Servomotor depends on the model of the SERVOPACK. For details, refer to the manual for the SERVOPACK.
  - If you use a SERVOPACK with the Dynamic Brake Hardware Option, the Servomotor stopping methods will be different from the stopping methods used without the Option or with other Hardware Options. For details, refer to the following manual.  
  $\Sigma$ -7-Series  $\Sigma$ -7S/ $\Sigma$ -7W SERVOPACK with Dynamic Brake Hardware Option Specifications Product Manual (Manual No.: SIEP S800001 73)
- Do not use the dynamic brake for any application other than an emergency stop. There is a risk of failure due to rapid deterioration of elements in the SERVOPACK and the risk of unexpected operation, machine damage, burning, or injury.

## NOTICE

- When you adjust the gain during system commissioning, use a measuring instrument to monitor the torque waveform and speed waveform and confirm that there is no vibration. If a high gain causes vibration, the Servomotor will be damaged quickly.
- Do not frequently turn the power supply ON and OFF. After you have started actual operation, allow at least one hour between turning the power supply ON and OFF (as a guideline). Do not use the product in applications that require the power supply to be turned ON and OFF frequently. The elements in the SERVOPACK will deteriorate quickly.
- An alarm or warning may occur if communications are performed with the host controller while the SigmaWin+ or Digital Operator is operating. If an alarm or warning occurs, it may interrupt the current process and stop the system.
- After you complete trial operation of the machine and facilities, use the SigmaWin+ to back up the settings of the SERVOPACK parameters. You can use them to reset the parameters after SERVOPACK replacement. If you do not copy backed up parameter settings, normal operation may not be possible after a faulty SERVOPACK is replaced, possibly resulting in machine or equipment damage.

### ■ Maintenance and Inspection Precautions



## DANGER

- Do not change any wiring while power is being supplied. There is a risk of electric shock or injury.



## WARNING

- Wiring and inspections must be performed only by qualified engineers. There is a risk of electric shock or product failure.



## CAUTION

- Wait for six minutes after turning OFF the power supply and then make sure that the CHARGE indicator is not lit before starting wiring or inspection work. Do not touch the power supply terminals while the CHARGE lamp is lit after turning OFF the power supply because high voltage may still remain in the SERVOPACK.  
There is a risk of electric shock.
- Before you replace a SERVOPACK, back up the settings of the SERVOPACK parameters. Copy the backed up parameter settings to the new SERVOPACK and confirm that they were copied correctly.  
If you do not copy backed up parameter settings or if the copy operation is not completed normally, normal operation may not be possible, possibly resulting in machine or equipment damage.

## NOTICE

- Discharge all static electricity from your body before you operate any of the buttons or switches inside the front cover of the SERVOPACK.  
There is a risk of equipment damage.

### ■ Troubleshooting Precautions



## DANGER

- If the safety device (molded-case circuit breaker or fuse) installed in the power supply line operates, remove the cause before you supply power to the SERVOPACK again. If necessary, repair or replace the SERVOPACK, check the wiring, and remove the factor that caused the safety device to operate.  
There is a risk of fire, electric shock, or injury.



## WARNING

- The product may suddenly start to operate when the power supply is recovered after a momentary power interruption. Design the machine to ensure human safety when operation restarts.  
There is a risk of injury.



## CAUTION

- When an alarm occurs, remove the cause of the alarm and ensure safety. Then reset the alarm or turn the power supply OFF and ON again to restart operation.  
There is a risk of injury or machine damage.
- If the Servo ON signal is input to the SERVOPACK and an alarm is reset, the Servomotor may suddenly restart operation. Confirm that the servo is OFF and ensure safety before you reset an alarm.  
There is a risk of injury or machine damage.
- Always insert a magnetic contactor in the line between the main circuit power supply and the main circuit power supply terminals on the SERVOPACK so that the power supply can be shut OFF at the main circuit power supply.  
If a magnetic contactor is not connected when the SERVOPACK fails, a large current may flow, possibly resulting in fire.
- If an alarm occurs, shut OFF the main circuit power supply.  
There is a risk of fire due to a regenerative resistor overheating as the result of regenerative transistor failure.
- Install a ground fault detector against overloads and short-circuiting or install a molded-case circuit breaker combined with a ground fault detector.  
There is a risk of SERVOPACK failure or fire if a ground fault occurs.
- The holding brake on a Servomotor will not ensure safety if there is the possibility that an external force (including gravity) may move the current position and create a hazardous situation when power is interrupted or an error occurs. If an external force may cause movement, install an external braking mechanism that ensures safety.

### ■ Disposal Precautions

- When disposing of the product, treat it as ordinary industrial waste. However, local ordinances and national laws must be observed. Implement all labeling and warnings as a final product as required.

### ■ General Precautions

- Figures provided in this document are typical examples or conceptual representations. There may be differences between them and actual wiring, circuits, and products.
- The products shown in illustrations in this document are sometimes shown without covers or protective guards. Always replace all covers and protective guards before you use the product.
- If you need a new copy of this document because it has been lost or damaged, contact your nearest Yaskawa representative or one of the offices listed on the back of this document.
- This document is subject to change without notice for product improvements, specifications changes, and improvements to the manual itself.  
We will update the document number of the document and issue revisions when changes are made.
- Any and all quality guarantees provided by Yaskawa are null and void if the customer modifies the product in any way. Yaskawa disavows any responsibility for damages or losses that are caused by modified products.

---

# Warranty

## ◆ Details of Warranty

### ■ Warranty Period

The warranty period for a product that was purchased (hereinafter called the “delivered product”) is one year from the time of delivery to the location specified by the customer or 18 months from the time of shipment from the Yaskawa factory, whichever is sooner.

### ■ Warranty Scope

Yaskawa shall replace or repair a defective product free of charge if a defect attributable to Yaskawa occurs during the above warranty period.

This warranty does not cover defects caused by the delivered product reaching the end of its service life and replacement of parts that require replacement or that have a limited service life.

This warranty does not cover failures that result from any of the following causes.

- Improper handling, abuse, or use in unsuitable conditions or in environments not described in product catalogs or manuals, or in any separately agreed-upon specifications
- Causes not attributable to the delivered product itself
- Modifications or repairs not performed by Yaskawa
- Use of the delivered product in a manner in which it was not originally intended
- Causes that were not foreseeable with the scientific and technological understanding at the time of shipment from Yaskawa
- Events for which Yaskawa is not responsible, such as natural or human-made disasters

## ◆ Limitations of Liability

- Yaskawa shall in no event be responsible for any damage or loss of opportunity to the customer that arises due to failure of the delivered product.
- Yaskawa shall not be responsible for any programs (including parameter settings) or the results of program execution of the programs provided by the user or by a third party for use with programmable Yaskawa products.
- The information described in product catalogs or manuals is provided for the purpose of the customer purchasing the appropriate product for the intended application. The use thereof does not guarantee that there are no infringements of intellectual property rights or other proprietary rights of Yaskawa or third parties, nor does it construe a license.
- Yaskawa shall not be responsible for any damage arising from infringements of intellectual property rights or other proprietary rights of third parties as a result of using the information described in catalogs or manuals.

---

## ◆ Suitability for Use

- It is the customer's responsibility to confirm conformity with any standards, codes, or regulations that apply if the Yaskawa product is used in combination with any other products.
- The customer must confirm that the Yaskawa product is suitable for the systems, machines, and equipment used by the customer.
- Consult with Yaskawa to determine whether use in the following applications is acceptable. If use in the application is acceptable, use the product with extra allowance in ratings and specifications, and provide safety measures to minimize hazards in the event of failure.
  - Outdoor use, use involving potential chemical contamination or electrical interference, or use in conditions or environments not described in product catalogs or manuals
  - Nuclear energy control systems, combustion systems, railroad systems, aviation systems, vehicle systems, medical equipment, amusement machines, and installations subject to separate industry or government regulations
  - Systems, machines, and equipment that may present a risk to life or property
  - Systems that require a high degree of reliability, such as systems that supply gas, water, or electricity, or systems that operate continuously 24 hours a day
  - Other systems that require a similar high degree of safety
- Never use the product for an application involving serious risk to life or property without first ensuring that the system is designed to secure the required level of safety with risk warnings and redundancy, and that the Yaskawa product is properly rated and installed.
- The circuit examples and other application examples described in product catalogs and manuals are for reference. Check the functionality and safety of the actual devices and equipment to be used before using the product.
- Read and understand all use prohibitions and precautions, and operate the Yaskawa product correctly to prevent accidental harm to third parties.

## ◆ Specifications Change

The names, specifications, appearance, and accessories of products in product catalogs and manuals may be changed at any time based on improvements and other reasons. The next editions of the revised catalogs or manuals will be published with updated code numbers. Consult with your Yaskawa representative to confirm the actual specifications before purchasing a product.

# Compliance with UL Standards and EU Directives

Certification marks for the standards for which the product has been certified by certification bodies are shown on nameplate. Products that do not have the marks are not certified for the standards.

## ◆ North American Safety Standards (UL)



Product	Model	North American Safety Standards (UL File No.)
SERVOPACKs	SGD7W	UL 61800-5-1 (E147823) CSA C22.2 No.274
Rotary Servomotors	<ul style="list-style-type: none"> <li>• SGM7M</li> <li>• SGM7A</li> <li>• SGM7J</li> <li>• SGM7P</li> <li>• SGM7G</li> <li>• SGMMV</li> </ul>	UL 1004-1 UL 1004-6 (E165827)
Direct Drive Servomotors	<ul style="list-style-type: none"> <li>• SGM7E</li> <li>• SGM7F</li> <li>• SGMCV</li> <li>• SGMCS-□□B, -□□C, -□□D, and -□□E (Small-Capacity, Coreless Servomotors)</li> </ul>	UL 1004-1 UL 1004-6 (E165827)
Linear Servomotors	<ul style="list-style-type: none"> <li>• SGLGW</li> <li>• SGLFW</li> <li>• SGLFW2</li> <li>• SGLTW</li> </ul>	UL 1004-1 UL 1004-6 (E165827)

\* Certification for the SGM7F-07A is pending.



◆ EU Directives



Product	Model	EU Directives	Harmonized Standards
SERVOPACKs	SGD7W	EMC Directive 2014/30/EU	EN 55011 group 1, class A EN 61000-6-2 EN 61000-6-4 EN 61800-3 (Category C2, Second environment)
		Low Voltage Directive 2014/35/EU	EN 50178 EN 61800-5-1
		RoHS Directive 2011/65/EU	EN 50581
Rotary Servomotors	SGMMV	EMC Directive 2004/108/EC	EN 55011 group 1, class A EN 61000-6-2 EN 61800-3 (Category C2, Second environment)
		Low Voltage Directive 2006/95/EC	EN 60034-1 EN 60034-5
		RoHS Directive 2011/65/EU	EN 50581
	<ul style="list-style-type: none"> <li>• SGM7M</li> <li>• SGM7J</li> <li>• SGM7A</li> <li>• SGM7P</li> <li>• SGM7G</li> </ul>	EMC Directive 2014/30/EU	EN 55011 group 1, class A EN 61000-6-2 EN 61000-6-4 EN 61800-3 (Category C2, Second environment)
		Low Voltage Directive 2014/35/EU	EN 60034-1 EN 60034-5
		RoHS Directive 2011/65/EU	EN 50581
Direct Drive Servomotors	<ul style="list-style-type: none"> <li>• SGM7E</li> <li>• SGM7F-□□A, -□□B, -□□C, and -□□D (Small-Capacity Servomotors with Cores)</li> <li>• SGMCV</li> <li>• SGMCS-□□B, -□□C, -□□D, and -□□E (Small-Capacity, Coreless Servomotors)</li> </ul>	EMC Directive 2014/30/EU	EN 55011 group 1, class A EN 61000-6-2 EN 61000-6-4 EN 61800-3 (Category C2, Second environment)
		Low Voltage Directive 2014/35/EU	EN 60034-1 EN 60034-5
		RoHS Directive 2011/65/EU	EN 50581
Linear Servomotors	<ul style="list-style-type: none"> <li>• SGLG</li> <li>• SGLF</li> <li>• SGLF□2</li> <li>• SGLT</li> </ul>	EMC Directive 2014/30/EU	EN 55011 group 1, class A EN 61000-6-2 EN 61000-6-4 EN 61800-3 (Category C2, Second environment)
		Low Voltage Directive 2014/35/EU	EN 60034-1
		RoHS Directive 2011/65/EU	EN 50581

Note: 1. We declared the CE Marking based on the harmonized standards in the above table.

2. These products are for industrial use. In home environments, these products may cause electromagnetic interference and additional noise reduction measures may be necessary.

# Contents

About this Manual .....	iii
Outline of Manual .....	iii
Related Documents .....	iv
Using This Manual .....	x
Safety Precautions .....	xiii
Warranty .....	xxii
Compliance with UL Standards and EU Directives .....	xxiv

## 1

### Basic Information on SERVOPACKs

<b>1.1</b>	<b>The <math>\Sigma</math>-7 Series .....</b>	<b>1-2</b>
<b>1.2</b>	<b>Interpreting the Nameplate .....</b>	<b>1-3</b>
<b>1.3</b>	<b>Part Names .....</b>	<b>1-4</b>
<b>1.4</b>	<b>Model Designations .....</b>	<b>1-6</b>
1.4.1	Interpreting SERVOPACK Model Numbers .....	1-6
1.4.2	Interpreting Servomotor Model Numbers .....	1-7
<b>1.5</b>	<b>Combinations of SERVOPACKs and Servomotors .....</b>	<b>1-9</b>
1.5.1	Combinations of Rotary Servomotors and SERVOPACKs .....	1-9
1.5.2	Combinations of Direct Drive Servomotors and SERVOPACKs .....	1-10
1.5.3	Combinations of Linear Servomotors and SERVOPACKs .....	1-11
<b>1.6</b>	<b>Functions .....</b>	<b>1-12</b>

## 2

### Selecting a SERVOPACK

<b>2.1</b>	<b>Ratings and Specifications .....</b>	<b>2-2</b>
2.1.1	Ratings .....	2-2
2.1.2	SERVOPACK Overload Protection Characteristics .....	2-4
2.1.3	Specifications .....	2-5
<b>2.2</b>	<b>Block Diagrams .....</b>	<b>2-8</b>
2.2.1	SGD7W-1R6A and -2R8A .....	2-8
2.2.2	SGD7W-5R5A and -7R6A .....	2-9
<b>2.3</b>	<b>External Dimensions .....</b>	<b>2-10</b>
2.3.1	Front Cover Dimensions and Connector Specifications .....	2-10
2.3.2	SERVOPACK External Dimensions .....	2-11
<b>2.4</b>	<b>Examples of Standard Connections between SERVOPACKs and Peripheral Devices ..</b>	<b>2-13</b>

# 3

## SERVOPACK Installation

<b>3.1</b>	<b>Installation Precautions . . . . .</b>	<b>3-2</b>
<b>3.2</b>	<b>Mounting Types and Orientation . . . . .</b>	<b>3-3</b>
<b>3.3</b>	<b>Mounting Hole Dimensions . . . . .</b>	<b>3-4</b>
<b>3.4</b>	<b>Mounting Interval . . . . .</b>	<b>3-5</b>
3.4.1	Installing One SERVOPACK in a Control Panel . . . . .	3-5
3.4.2	Installing More Than One SERVOPACK in a Control Panel . . . . .	3-5
<b>3.5</b>	<b>Monitoring the Installation Environment . . . . .</b>	<b>3-6</b>
<b>3.6</b>	<b>Derating Specifications . . . . .</b>	<b>3-7</b>
<b>3.7</b>	<b>EMC Installation Conditions . . . . .</b>	<b>3-8</b>

# 4

## Wiring and Connecting SERVOPACKs

<b>4.1</b>	<b>Wiring and Connecting SERVOPACKs . . . . .</b>	<b>4-3</b>
4.1.1	General Precautions . . . . .	4-3
4.1.2	Countermeasures against Noise . . . . .	4-6
4.1.3	Grounding . . . . .	4-9
<b>4.2</b>	<b>Basic Wiring Diagrams . . . . .</b>	<b>4-10</b>
<b>4.3</b>	<b>Wiring the Power Supply to the SERVOPACK . . . . .</b>	<b>4-11</b>
4.3.1	Terminal Symbols and Terminal Names . . . . .	4-11
4.3.2	Wiring Procedure for Main Circuit Connector . . . . .	4-12
4.3.3	Power ON Sequence . . . . .	4-13
4.3.4	Power Supply Wiring Diagrams . . . . .	4-14
4.3.5	Wiring Regenerative Resistors . . . . .	4-18
4.3.6	Wiring Reactors for Harmonic Suppression . . . . .	4-19
<b>4.4</b>	<b>Wiring Servomotors . . . . .</b>	<b>4-20</b>
4.4.1	Terminal Symbols and Terminal Names . . . . .	4-20
4.4.2	Pin Arrangement of Encoder Connectors (CN2A and CN2B) . . . . .	4-20
4.4.3	Wiring the SERVOPACK to the Encoder . . . . .	4-21
4.4.4	Wiring the SERVOPACK to the Holding Brake . . . . .	4-30
<b>4.5</b>	<b>I/O Signal Connections . . . . .</b>	<b>4-32</b>
4.5.1	I/O Signal Connector (CN1) Names and Functions . . . . .	4-32
4.5.2	I/O Signal Connector (CN1) Pin Arrangement . . . . .	4-34
4.5.3	I/O Signal Wiring Examples . . . . .	4-35
4.5.4	I/O Circuits . . . . .	4-37
<b>4.6</b>	<b>Connecting MECHATROLINK-III Communications Cables (RJ-45) . .</b>	<b>4-39</b>
<b>4.7</b>	<b>Connecting the Other Connectors . . . . .</b>	<b>4-40</b>
4.7.1	Serial Communications Connector (CN502) . . . . .	4-40
4.7.2	Computer Connector (CN7) . . . . .	4-40
4.7.3	Analog Monitor Connector (CN5) . . . . .	4-41

# 5

## Basic Functions That Require Setting before Operation

<b>5.1</b>	<b>Manipulating Parameters (Pn□□□) . . . . .</b>	<b>5-3</b>
5.1.1	Parameter Classification . . . . .	5-3
5.1.2	Notation for Parameters . . . . .	5-4
5.1.3	Parameter Setting Methods . . . . .	5-5
5.1.4	Write Prohibition Setting for Parameters . . . . .	5-6
5.1.5	Initializing Parameter Settings . . . . .	5-9
<b>5.2</b>	<b>MECHATROLINK-III Communications Settings . . . . .</b>	<b>5-11</b>
5.2.1	Communications Settings . . . . .	5-11
5.2.2	Setting the Station Address . . . . .	5-11
5.2.3	Extended Address Setting . . . . .	5-12
<b>5.3</b>	<b>Power Supply Type Settings for the Main Circuit and Control Circuit. . .</b>	<b>5-13</b>
5.3.1	AC Power Supply Input/DC Power Supply Input Setting . . . . .	5-13
5.3.2	Single-phase AC Power Supply Input/Three-phase AC Power Supply Input Setting . . . . .	5-14
<b>5.4</b>	<b>Automatic Detection of Connected Motor . . . . .</b>	<b>5-15</b>
<b>5.5</b>	<b>Motor Direction Setting . . . . .</b>	<b>5-16</b>
<b>5.6</b>	<b>Setting the Linear Encoder Pitch . . . . .</b>	<b>5-17</b>
<b>5.7</b>	<b>Writing Linear Servomotor Parameters . . . . .</b>	<b>5-18</b>
<b>5.8</b>	<b>Selecting the Phase Sequence for a Linear Servomotor . . . . .</b>	<b>5-22</b>
<b>5.9</b>	<b>Polarity Sensor Setting. . . . .</b>	<b>5-24</b>
<b>5.10</b>	<b>Polarity Detection. . . . .</b>	<b>5-25</b>
5.10.1	Restrictions . . . . .	5-25
5.10.2	Using the SV_ON (Servo ON) Command to Perform Polarity Detection . . .	5-26
5.10.3	Using a Tool Function to Perform Polarity Detection. . . . .	5-27
<b>5.11</b>	<b>Overtravel and Related Settings . . . . .</b>	<b>5-28</b>
5.11.1	Overtravel Signals . . . . .	5-29
5.11.2	Setting to Enable/Disable Overtravel . . . . .	5-29
5.11.3	Motor Stopping Method for Overtravel . . . . .	5-30
5.11.4	Overtravel Warnings . . . . .	5-31
<b>5.12</b>	<b>Holding Brake. . . . .</b>	<b>5-33</b>
5.12.1	Brake Operating Sequence. . . . .	5-33
5.12.2	/BK (Brake) Signal . . . . .	5-34
5.12.3	Output Timing of /BK (Brake) Signal When the Servomotor Is Stopped . . .	5-35
5.12.4	Output Timing of /BK (Brake) Signal When the Servomotor Is Operating . .	5-36
<b>5.13</b>	<b>Motor Stopping Methods for Servo OFF and Alarms. . . . .</b>	<b>5-38</b>
5.13.1	Stopping Method for Servo OFF. . . . .	5-38
5.13.2	Servomotor Stopping Method for Alarms . . . . .	5-39
<b>5.14</b>	<b>Motor Overload Detection Level . . . . .</b>	<b>5-41</b>
5.14.1	Detection Timing for Overload Warnings (A.910) . . . . .	5-41
5.14.2	Detection Timing for Overload Alarms (A.720) . . . . .	5-42

<b>5.15</b>	<b>Electronic Gear Settings</b> . . . . .	<b>5-43</b>
5.15.1	Electronic Gear Ratio Settings . . . . .	5-44
5.15.2	Electronic Gear Ratio Setting Examples . . . . .	5-47
<b>5.16</b>	<b>Resetting the Absolute Encoder</b> . . . . .	<b>5-48</b>
5.16.1	Precautions on Resetting . . . . .	5-48
5.16.2	Preparations . . . . .	5-48
5.16.3	Applicable Tools . . . . .	5-49
5.16.4	Operating Procedure . . . . .	5-49
<b>5.17</b>	<b>Setting the Origin of the Absolute Encoder</b> . . . . .	<b>5-51</b>
5.17.1	Absolute Encoder Origin Offset . . . . .	5-51
5.17.2	Setting the Origin of the Absolute Linear Encoder . . . . .	5-51
<b>5.18</b>	<b>Setting the Regenerative Resistor Capacity</b> . . . . .	<b>5-54</b>

## 6 Application Functions

<b>6.1</b>	<b>I/O Signal Allocations</b> . . . . .	<b>6-3</b>
6.1.1	Input Signal Allocations . . . . .	6-3
6.1.2	Output Signal Allocations . . . . .	6-6
6.1.3	ALM (Servo Alarm) Signal . . . . .	6-10
6.1.4	/WARN (Warning) Signal . . . . .	6-10
6.1.5	/TGON (Rotation Detection) Signal . . . . .	6-11
6.1.6	/S-RDY (Servo Ready) Signal . . . . .	6-12
6.1.7	/V-CMP (Speed Coincidence Detection) Signal . . . . .	6-12
6.1.8	/COIN (Positioning Completion) Signal . . . . .	6-13
6.1.9	/NEAR (Near) Signal . . . . .	6-14
6.1.10	Speed Limit during Torque Control . . . . .	6-15
<b>6.2</b>	<b>Operation for Momentary Power Interruptions</b> . . . . .	<b>6-17</b>
<b>6.3</b>	<b>SEMI F47 Function</b> . . . . .	<b>6-18</b>
<b>6.4</b>	<b>Setting the Motor Maximum Speed</b> . . . . .	<b>6-20</b>
<b>6.5</b>	<b>Software Limits</b> . . . . .	<b>6-21</b>
6.5.1	Setting to Enable/Disable Software Limits . . . . .	6-21
6.5.2	Setting the Software Limits . . . . .	6-21
6.5.3	Software Limit Check for References . . . . .	6-21
<b>6.6</b>	<b>Selecting Torque Limits</b> . . . . .	<b>6-22</b>
6.6.1	Internal Torque Limits . . . . .	6-22
6.6.2	External Torque Limits . . . . .	6-23
6.6.3	/CLT (Torque Limit Detection) Signal . . . . .	6-26
<b>6.7</b>	<b>Absolute Encoders</b> . . . . .	<b>6-27</b>
6.7.1	Connecting an Absolute Encoder . . . . .	6-28
6.7.2	Structure of the Position Data of the Absolute Encoder . . . . .	6-28
6.7.3	Reading the Position Data from the Absolute Encoder . . . . .	6-28
6.7.4	Multiturn Limit Setting . . . . .	6-28
6.7.5	Multiturn Limit Disagreement Alarm (A.CC0) . . . . .	6-30

<b>6.8</b>	<b>Absolute Linear Encoders</b> . . . . .	<b>6-33</b>
6.8.1	Connecting an Absolute Linear Encoder. . . . .	6-33
6.8.2	Structure of the Position Data of the Absolute Linear Encoder. . . . .	6-33
6.8.3	Reading the Position Data from the Absolute Linear Encoder. . . . .	6-33
<b>6.9</b>	<b>Software Reset</b> . . . . .	<b>6-34</b>
6.9.1	Preparations . . . . .	6-34
6.9.2	Applicable Tools . . . . .	6-34
6.9.3	Operating Procedure . . . . .	6-35
<b>6.10</b>	<b>Initializing the Vibration Detection Level</b> . . . . .	<b>6-37</b>
6.10.1	Preparations . . . . .	6-37
6.10.2	Applicable Tools . . . . .	6-37
6.10.3	Operating Procedure . . . . .	6-38
6.10.4	Related Parameters . . . . .	6-39
<b>6.11</b>	<b>Adjusting the Motor Current Detection Signal Offset</b> . . . . .	<b>6-41</b>
6.11.1	Automatic Adjustment . . . . .	6-41
6.11.2	Manual Adjustment. . . . .	6-43
<b>6.12</b>	<b>Forcing the Motor to Stop</b> . . . . .	<b>6-45</b>
6.12.1	FSTP (Forced Stop Input) Signal . . . . .	6-45
6.12.2	Stopping Method Selection for Forced Stops. . . . .	6-46
6.12.3	Resetting Method for Forced Stops . . . . .	6-47
<b>6.13</b>	<b>Overheat Protection</b> . . . . .	<b>6-48</b>
6.13.1	Connecting the Overheat Protection Input (TH) Signal . . . . .	6-48
6.13.2	Overheat Protection Selection . . . . .	6-48

# 7

## Trial Operation and Actual Operation

<b>7.1</b>	<b>Flow of Trial Operation</b> . . . . .	<b>7-2</b>
7.1.1	Flow of Trial Operation for Rotary Servomotors . . . . .	7-2
7.1.2	Flow of Trial Operation for Linear Servomotors. . . . .	7-3
<b>7.2</b>	<b>Inspections and Confirmations before Trial Operation</b> . . . . .	<b>7-6</b>
<b>7.3</b>	<b>Trial Operation for the Servomotor without a Load</b> . . . . .	<b>7-7</b>
7.3.1	Preparations . . . . .	7-7
7.3.2	Applicable Tools . . . . .	7-8
7.3.3	Operating Procedure . . . . .	7-8
<b>7.4</b>	<b>Trial Operation with MECHATROLINK-III Communications</b> . . .	<b>7-10</b>
<b>7.5</b>	<b>Trial Operation with the Servomotor Connected to the Machine</b> . . .	<b>7-12</b>
7.5.1	Precautions . . . . .	7-12
7.5.2	Preparations. . . . .	7-12
7.5.3	Operating Procedure . . . . .	7-13
<b>7.6</b>	<b>Convenient Function to Use during Trial Operation.</b> . . . . .	<b>7-14</b>
7.6.1	Program Jogging . . . . .	7-14
7.6.2	Origin Search . . . . .	7-20
7.6.3	Test without a Motor. . . . .	7-23
<b>7.7</b>	<b>Operation Using MECHATROLINK-III Commands</b> . . . . .	<b>7-26</b>

# 8

## Tuning

<b>8.1</b>	<b>Overview and Flow of Tuning . . . . .</b>	<b>8-4</b>
8.1.1	Tuning Functions . . . . .	8-5
8.1.2	Diagnostic Tool . . . . .	8-6
<b>8.2</b>	<b>Monitoring Methods . . . . .</b>	<b>8-7</b>
<b>8.3</b>	<b>Precautions to Ensure Safe Tuning . . . . .</b>	<b>8-8</b>
8.3.1	Overtravel Settings . . . . .	8-8
8.3.2	Torque Limit Settings . . . . .	8-8
8.3.3	Setting the Position Deviation Overflow Alarm Level . . . . .	8-8
8.3.4	Vibration Detection Level Setting . . . . .	8-10
8.3.5	Setting the Position Deviation Overflow Alarm Level at Servo ON . . . . .	8-10
<b>8.4</b>	<b>Tuning-less Function . . . . .</b>	<b>8-12</b>
8.4.1	Application Restrictions . . . . .	8-12
8.4.2	Operating Procedure . . . . .	8-13
8.4.3	Troubleshooting Alarms . . . . .	8-14
8.4.4	Parameters Disabled by Tuning-less Function . . . . .	8-15
8.4.5	Automatically Adjusted Function Setting . . . . .	8-15
8.4.6	Related Parameters . . . . .	8-15
<b>8.5</b>	<b>Estimating the Moment of Inertia . . . . .</b>	<b>8-16</b>
8.5.1	Outline . . . . .	8-16
8.5.2	Restrictions . . . . .	8-16
8.5.3	Applicable Tools . . . . .	8-17
8.5.4	Operating Procedure . . . . .	8-17
<b>8.6</b>	<b>Autotuning without Host Reference . . . . .</b>	<b>8-24</b>
8.6.1	Outline . . . . .	8-24
8.6.2	Restrictions . . . . .	8-25
8.6.3	Applicable Tools . . . . .	8-26
8.6.4	Operating Procedure . . . . .	8-26
8.6.5	Troubleshooting Problems in Autotuning without a Host Reference . . . . .	8-30
8.6.6	Automatically Adjusted Function Settings . . . . .	8-32
8.6.7	Related Parameters . . . . .	8-34
<b>8.7</b>	<b>Autotuning with a Host Reference . . . . .</b>	<b>8-35</b>
8.7.1	Outline . . . . .	8-35
8.7.2	Restrictions . . . . .	8-36
8.7.3	Applicable Tools . . . . .	8-36
8.7.4	Operating Procedure . . . . .	8-37
8.7.5	Troubleshooting Problems in Autotuning with a Host Reference . . . . .	8-41
8.7.6	Automatically Adjusted Function Settings . . . . .	8-41
8.7.7	Related Parameters . . . . .	8-42
<b>8.8</b>	<b>Custom Tuning . . . . .</b>	<b>8-43</b>
8.8.1	Outline . . . . .	8-43
8.8.2	Preparations . . . . .	8-43
8.8.3	Applicable Tools . . . . .	8-44
8.8.4	Operating Procedure . . . . .	8-44
8.8.5	Automatically Adjusted Function Settings . . . . .	8-50
8.8.6	Tuning Example for Tuning Mode 2 or 3 . . . . .	8-50
8.8.7	Related Parameters . . . . .	8-51

<b>8.9</b>	<b>Anti-Resonance Control Adjustment</b> . . . . .	<b>8-52</b>
8.9.1	Outline . . . . .	8-52
8.9.2	Preparations . . . . .	8-52
8.9.3	Applicable Tools . . . . .	8-53
8.9.4	Operating Procedure . . . . .	8-53
8.9.5	Related Parameters . . . . .	8-55
8.9.6	Suppressing Different Vibration Frequencies with Anti-resonance Control . . . . .	8-55
<b>8.10</b>	<b>Vibration Suppression</b> . . . . .	<b>8-57</b>
8.10.1	Outline . . . . .	8-57
8.10.2	Preparations . . . . .	8-58
8.10.3	Applicable Tools . . . . .	8-58
8.10.4	Operating Procedure . . . . .	8-59
8.10.5	Setting Combined Functions . . . . .	8-61
8.10.6	Related Parameters . . . . .	8-61
<b>8.11</b>	<b>Speed Ripple Compensation</b> . . . . .	<b>8-62</b>
8.11.1	Outline . . . . .	8-62
8.11.2	Setting Up Speed Ripple Compensation . . . . .	8-62
8.11.3	Setting Parameters . . . . .	8-66
<b>8.12</b>	<b>Additional Adjustment Functions</b> . . . . .	<b>8-68</b>
8.12.1	Gain Switching . . . . .	8-68
8.12.2	Friction Compensation . . . . .	8-72
8.12.3	Gravity Compensation . . . . .	8-74
8.12.4	Current Control Mode Selection . . . . .	8-75
8.12.5	Current Gain Level Setting . . . . .	8-75
8.12.6	Speed Detection Method Selection . . . . .	8-76
8.12.7	Speed Feedback Filter . . . . .	8-76
8.12.8	Backlash Compensation . . . . .	8-76
<b>8.13</b>	<b>Manual Tuning</b> . . . . .	<b>8-82</b>
8.13.1	Tuning the Servo Gains . . . . .	8-82
8.13.2	Compatible Adjustment Functions . . . . .	8-92
<b>8.14</b>	<b>Diagnostic Tools</b> . . . . .	<b>8-96</b>
8.14.1	Mechanical Analysis . . . . .	8-96
8.14.2	Easy FFT . . . . .	8-97

# 9

## Monitoring

<b>9.1</b>	<b>Monitoring Product Information</b> . . . . .	<b>9-2</b>
9.1.1	Items That You Can Monitor . . . . .	9-2
9.1.2	Operating Procedures . . . . .	9-2
<b>9.2</b>	<b>Monitoring SERVOPACK Status</b> . . . . .	<b>9-3</b>
9.2.1	Servo Drive Status . . . . .	9-3
9.2.2	Monitoring Status and Operations . . . . .	9-3
9.2.3	I/O Signal Monitor . . . . .	9-5
<b>9.3</b>	<b>Monitoring Machine Operation Status and Signal Waveforms</b> . .	<b>9-6</b>
9.3.1	Items That You Can Monitor . . . . .	9-6
9.3.2	Using the SigmaWin+ . . . . .	9-7
9.3.3	Using the Analog Monitors . . . . .	9-8



<b>9.4</b>	<b>Monitoring Product Life</b> . . . . .	<b>9-14</b>
9.4.1	Items That You Can Monitor . . . . .	9-14
9.4.2	Operating Procedure . . . . .	9-15
9.4.3	Preventative Maintenance . . . . .	9-16
<b>9.5</b>	<b>Alarm Tracing</b> . . . . .	<b>9-17</b>
9.5.1	Data for Which Alarm Tracing Is Performed . . . . .	9-17
9.5.2	Applicable Tools . . . . .	9-17

## 10 Maintenance

<b>10.1</b>	<b>Inspections and Part Replacement</b> . . . . .	<b>10-2</b>
10.1.1	Inspections . . . . .	10-2
10.1.2	Guidelines for Part Replacement . . . . .	10-2
10.1.3	Replacing the Battery . . . . .	10-3
<b>10.2</b>	<b>Alarm Displays</b> . . . . .	<b>10-5</b>
10.2.1	List of Alarms . . . . .	10-5
10.2.2	Troubleshooting Alarms . . . . .	10-10
10.2.3	Resetting Alarms . . . . .	10-38
10.2.4	Displaying the Alarm History . . . . .	10-39
10.2.5	Clearing the Alarm History . . . . .	10-40
10.2.6	Resetting Motor Type Alarms . . . . .	10-41
<b>10.3</b>	<b>Warning Displays</b> . . . . .	<b>10-42</b>
10.3.1	List of Warnings . . . . .	10-42
10.3.2	Troubleshooting Warnings . . . . .	10-44
<b>10.4</b>	<b>Monitoring Communications Data during Alarms or Warnings</b> . .	<b>10-51</b>
<b>10.5</b>	<b>Troubleshooting Based on the Operation and Conditions of the Servomotor</b> . .	<b>10-52</b>

## 11 Parameter Lists

<b>11.1</b>	<b>List of Servo Parameters</b> . . . . .	<b>11-2</b>
11.1.1	Interpreting the Parameter Lists . . . . .	11-2
11.1.2	List of Servo Parameters . . . . .	11-3
<b>11.2</b>	<b>List of MECHATROLINK-III Common Parameters</b> . . . . .	<b>11-54</b>
11.2.1	Interpreting the Parameter Lists . . . . .	11-54
11.2.2	List of MECHATROLINK-III Common Parameters . . . . .	11-54
<b>11.3</b>	<b>Parameter Recording Table</b> . . . . .	<b>11-63</b>

---

# 12

## Appendices

---

<b>12.1</b>	<b>Interpreting Panel Displays . . . . .</b>	<b>12-2</b>
12.1.1	Interpreting Status Displays . . . . .	12-2
12.1.2	Alarm and Warning Displays . . . . .	12-2
12.1.3	Overtravel Display . . . . .	12-2
12.1.4	Forced Stop Display . . . . .	12-2
<b>12.2</b>	<b>Corresponding SERVOPACK and SigmaWin+ Function Names . .</b>	<b>12-3</b>
12.2.1	Corresponding SERVOPACK Utility Function Names . . . . .	12-3
12.2.2	Corresponding SERVOPACK Monitor Display Function Names . . . . .	12-4

### Index

### Revision History

# Basic Information on SERVOPACKs

# 1

This chapter provides information required to select SERVOPACKs, such as SERVOPACK models and combinations with Servomotors.

<b>1.1</b>	<b>The <math>\Sigma</math>-7 Series</b> . . . . .	<b>1-2</b>
<b>1.2</b>	<b>Interpreting the Nameplate</b> . . . . .	<b>1-3</b>
<b>1.3</b>	<b>Part Names</b> . . . . .	<b>1-4</b>
<b>1.4</b>	<b>Model Designations</b> . . . . .	<b>1-6</b>
1.4.1	Interpreting SERVOPACK Model Numbers . . . . .	1-6
1.4.2	Interpreting Servomotor Model Numbers . . . . .	1-7
<b>1.5</b>	<b>Combinations of SERVOPACKs and Servomotors</b> . .	<b>1-9</b>
1.5.1	Combinations of Rotary Servomotors and SERVOPACKs . . . . .	1-9
1.5.2	Combinations of Direct Drive Servomotors and SERVOPACKs . . . . .	1-10
1.5.3	Combinations of Linear Servomotors and SERVOPACKs . . . . .	1-11
<b>1.6</b>	<b>Functions</b> . . . . .	<b>1-12</b>

## 1.1 The $\Sigma$ -7 Series

The  $\Sigma$ -7-series SERVOPACKs are designed for applications that require frequent high-speed and high-precision positioning. The SERVOPACK will make the most of machine performance in the shortest time possible, thus contributing to improving productivity.

The following three types of  $\Sigma$ -7-Series Servo Drives are available.

Type	Description
$\Sigma$ -7S	Single-axis SERVOPACKs
$\Sigma$ -7W	Two-axis SERVOPACKs
$\Sigma$ -7C	Two-axis SERVOPACKs with Built-in Controllers

**Information** In this manual, the axes are called axis A and axis B. However, they are displayed as "axis 1," "axis 2," "AXIS#00," or "AXIS#01" on the Engineering Tool.

# 1.2 Interpreting the Nameplate

The following basic information is provided on the nameplate.

ground wire marked with symbol.  
Connectez le fil de terre à la borne repérée par ce symbole.

SERVOPACK model → **SERVOPACK MODEL SGD7W-1R6A30A001 IP20** ← Degree of protection

INPUT	MAIN	1PH/3PH 200-240V 50/60Hz 1PH:5.5A 3PH:2.5A	SURROUNDING AIR TEMPERATURE -5 to 55°C
	CONT.	1PH 200-240V 50/60Hz 0.25A	
OUTPUT	3PH 0-240V 0-500Hz 1.6A 200W/axis x2		

← Surrounding air temperature

BTO information → \*\*\*\*\*  
BTO/N\*\*\*\*\*  
\*\*\*\*\*  
\*\*\*\*\*

Order number → O/N \*\*\*\*\*

Serial number → S/N \*\*\*\*\*

UL CERTIFIED E147823  
CE  
TUV SUD  
YASKAWA

YASKAWA ELECTRIC CORPORATION  
2-1 Kurosakishi-iroishi, Yahatanishi-ku,  
Kitakyusyu 806-0004 Japan MADE IN JAPAN

# 1.3 Part Names

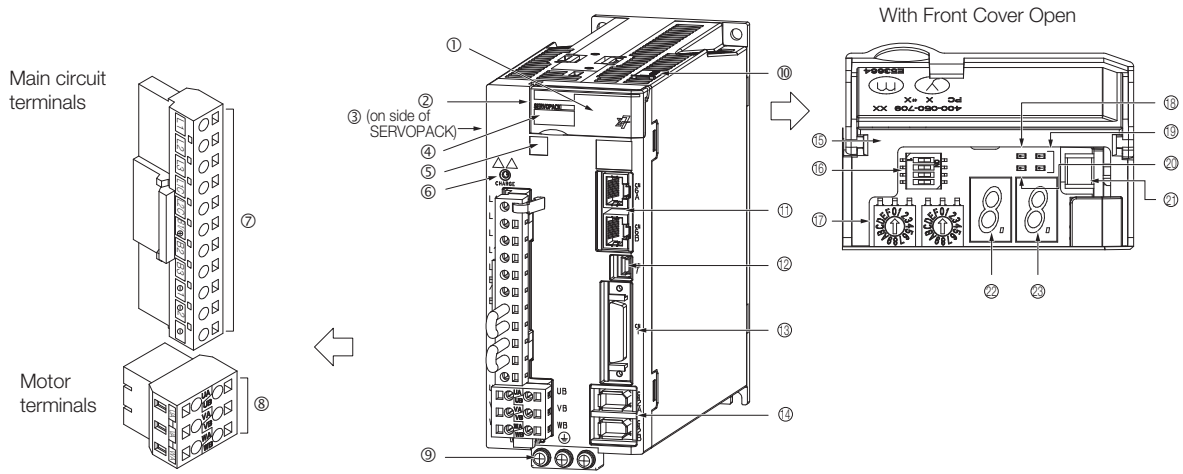

No.	Name	Description	Reference
①	Front Cover	—	—
②	Input Voltage	—	—
③	Nameplate	Indicates the SERVOPACK model and ratings.	page 1-3
④	Model	The model of the SERVOPACK.	page 1-6
⑤	QR Code	The QR code that is used by the MechatroCloud service.	—
⑥	CHARGE	Lit while the main circuit power is being supplied. Note: Even if you turn OFF the main circuit power supply, this indicator will be lit as long as the internal capacitor remains charged. Do not touch the main circuit or motor terminals while this indicator is lit. Doing so may result in electric shock.	—
⑦	Main Circuit Terminals	The terminals depend on the main circuit power supply input specifications of the SERVOPACK.	page 4-11
⑧	Servomotor Terminals (Axis A: UA, VA, and WA; Axis B: UB, VB, and WB)	The connection terminals for the Servomotor Main Circuit Cable (power line).	page 4-21
⑨	Ground Terminal (⊕)	The ground terminals to prevent electric shock. Always connect this terminal.	—
⑩	Serial Communications Connector (CN502)	Connects to the Digital Operator. However, a Communications Unit (JUSP-JC001-1) is required to connect a Digital Operator.	page 4-41
⑪	MECHATROLINK-III Communications Connector (CN6A and CN6B)	Connects to MECHATROLINK-III-compatible devices.	page 4-40
⑫	Computer Connector (CN7)	A USB connector to connect a computer.	page 4-41
⑬	I/O Signal Connector (CN1)	Connects to sequence I/O signals.	page 4-33
⑭	Encoder Connectors (Axis A: CN2A, Axis B: CN2B)	<ul style="list-style-type: none"> <li>Rotary Servomotor: Connects to the encoder in the Servomotor.</li> <li>Linear Servomotor: Connects to a Serial Converter Unit or linear encoder.</li> </ul>	page 4-21
⑮	Serial Number	—	—
⑯	DIP Switch (S3)	Used to set MECHATROLINK-III communications.	page 5-11
⑰	Rotary Switches (S1 and S2)	Used to set the MECHATROLINK station address.	
⑱	PWR	Lights when the control power is being supplied.	—
⑲	L1, L2	Lights during MECHATROLINK communications.	—
⑳	CN	Lights when the SERVOPACK normally receives a CONNECT command.	—

Continued on next page.

Continued from previous page.

No.	Name	Description	Reference
①	Analog Monitor Connector (CN5)	You can use a special cable (peripheral device) to monitor the motor speed, torque reference, or other values.	page 4-42
②	Panel Display for Axis A	Displays the servo status with a seven-segment display.	-
③	Panel Display for Axis B		

# 1.4 Model Designations

## 1.4.1 Interpreting SERVOPACK Model Numbers

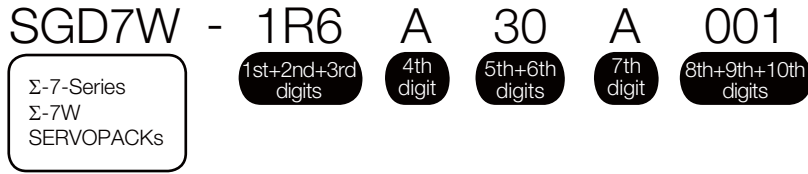

**1st+2nd+3rd digits** Maximum Applicable Motor Capacity per Axis

Voltage	Code	Specification
Three-Phase, 200 VAC	1R6*1	0.2 kW
	2R8*1	0.4 kW
	5R5*1*2	0.75 kW
	7R6	1.0 kW

**4th digit** Voltage

Code	Specification
A	200 VAC

**5th+6th digits** Interface\*3

Code	Specification
30	MECHATROLINK-III communications references and RJ-45 connectors

**7th digit** Design Revision Order  
A

**8th+9th+10th digits** Hardware Options Specification

Code	Specification	Applicable Models
None	Without options	All models
000		
001		
002	Rack-mounted	
	Varnished	
020*4	No dynamic brake	SGD7W-1R6A to -2R8A
	External dynamic brake resistor	SGD7W-5R5A to -7R6A

**11th+12th+13th digits** FT/EX Specification

Code	Specification
None	None
000	

**14th digit** BTO Specification\*5

Code	Specification
None	None
B	BTO

- \*1. You can use these models with either a single-phase or three-phase input.
- \*2. If you use the Servomotor with a single-phase 200-VAC power supply input, derate the load ratio to 65%. An example is given below. If the load ratio of the first axis is 90%, use a load ratio of 40% for the second axis so that average load ratio for both axes is 65%.  
 $((90\% + 40\%)/2 = 65\%)$
- \*3. The same SERVOPACKs are used for both Rotary Servomotors and Linear Servomotors.
- \*4. Refer to the following manual for details.  
 Σ-7-Series Σ-7S/Σ-7W SERVOPACK with Dynamic Brake Hardware Option Specifications Product Manual (Manual No.: SIEP S800001 73)
- \*5. The BTO specification indicates if the SERVOPACK is customized by using the MechatroCloud BTO service. You need a BTO number to order SERVOPACKs with customized specifications. Refer to the following catalog for details on the BTO specification.  
 AC Servo Drives Σ-7 Series (Manual No.: KAEP S800001 23)



## 1.4.2 Interpreting Servomotor Model Numbers

This section outlines the model numbers of  $\Sigma$ -7-series Servomotors. Refer to the relevant manual in the following list for details.

📖  $\Sigma$ -7-Series Rotary Servomotor Product Manual (Manual No.: SIEP S800001 36)

📖  $\Sigma$ -7-Series Linear Servomotor Product Manual (Manual No.: SIEP S800001 37)

📖  $\Sigma$ -7-Series Direct Drive Servomotor Product Manual (Manual No.: SIEP S800001 38)

### Rotary Servomotors

SGM□□ - 01 A F A 2 1

Series      1st+2nd digits      3rd digit      4th digit      5th digit      6th digit      7th digit

Code	Specification	1st+2nd digits	3rd digit	4th digit	5th digit	6th digit	7th digit
SGM7M	Low inertia , ultra-small capacity	Rated Output Power Supply Voltage • 200 VAC Serial Encoder Specification • 17-bit absolute encoder • 20-bit absolute encoder • 24-bit batteryless absolute encoder • 24-bit absolute encoder • 24-bit incremental encoder	200 VAC	Serial Encoder Specification • 17-bit absolute encoder • 20-bit absolute encoder • 24-bit batteryless absolute encoder • 24-bit absolute encoder • 24-bit incremental encoder	Design Revision Order	Shaft End Specification • Straight • With key and tap • With two flat seats	Option Specification • With 24-V holding brake • With oil seal
SGM7J	Medium inertia, high speed						
SGM7A	Low inertia, high speed						
SGM7P	Medium inertia, flat						
SGM7G	Medium inertia, low speed, high torque						
SGMMV	Low inertia, ultra-small capacity						

### Direct Drive Servomotors

SGM□□ - 02 B 3 C 1 1

Series      1st+2nd digits      3rd digit      4th digit      5th digit      6th digit      7th digit

Code	Specification	1st+2nd digits	3rd digit	4th digit	5th digit	6th digit	7th digit
SGM7E	Small capacity, coreless, inner rotor	Rated Torque Servomotor Outer Diameter Serial Encoder Specification	Servomotor Outer Diameter	Serial Encoder Specification	Design Revision Order	Flange Specification • Cable drawn to load side • Cable drawn to non-load side	Option Specification • High mechanical precision
SGM7F	Small capacity, with core, inner rotor Medium capacity, with core, inner rotor						
SGM7CV	Small capacity, with core, inner rotor						
SGM7CS	Small capacity, coreless, inner rotor Medium capacity, with core, inner rotor						

## Linear Servomotors

SGL □ □ - 30 A 050 C P □

Series      1st digit      2nd digit      3rd digit on

Series      Σ-7 Series Servomotors      2nd digit      Moving Coil/Magnetic Way

1st digit      Servomotor Type

Code	Specification
G	Coreless models
F	Models with F-type iron core
T	Models with T-type iron core

Code	Specification
W	Moving Coil
W2	
M	Magnetic Way
M2	

3rd digit on

The specifications for the 3rd digit on depend on the Servomotor type.

## 1.5

## Combinations of SERVOPACKs and Servomotors

## 1.5.1

## Combinations of Rotary Servomotors and SERVOPACKs

Rotary Servomotor Model		Capacity	SERVOPACK Model
			SGD7W-
SGM7M (Low inertia, ultra-small capacity), 3000 min <sup>-1</sup>	SGM7M-A1A	11 W	1R6A* <sup>1</sup> or 2R8A* <sup>1</sup>
	SGM7M-A2A	22 W	
	SGM7M-A3A	33 W	1R6A or 2R8A* <sup>1</sup>
SGM7J (Medium Inertia, Small Capacity), 3,000 min <sup>-1</sup>	SGM7J-A5A	50 W	1R6A* <sup>1</sup> or 2R8A* <sup>1</sup>
	SGM7J-01A	100 W	
	SGM7J-C2A	150 W	1R6A or 2R8A* <sup>1</sup>
	SGM7J-02A	200 W	
	SGM7J-04A	400 W	2R8A, 5R5A* <sup>1</sup> , or 7R6A* <sup>1</sup>
	SGM7J-06A	600 W	
	SGM7J-08A	750 W	
SGM7A (Low Inertia, Small Capacity), 3,000 min <sup>-1</sup>	SGM7A-A5A	50 W	1R6A* <sup>1</sup> or 2R8A* <sup>1</sup>
	SGM7A-01A	100 W	
	SGM7A-C2A	150 W	1R6A or 2R8A* <sup>1</sup>
	SGM7A-02A	200 W	
	SGM7A-04A	400 W	2R8A, 5R5A* <sup>1</sup> , or 7R6A* <sup>1</sup>
	SGM7A-06A	600 W	
	SGM7A-08A	750 W	
SGM7P (Medium Inertia, Flat), 3,000 min <sup>-1</sup>	SGM7P-01A	100 W	1R6A* <sup>1</sup> or 2R8A* <sup>1</sup>
	SGM7P-02A	200 W	2R8A, 5R5A* <sup>1</sup> , or 7R6A* <sup>1</sup>
	SGM7P-04A	400 W	
	SGM7P-08A	750 W	5R5A or 7R6A
SGM7G (Medium Inertia, Medium Capacity), 1,500 min <sup>-1</sup>	SGM7G-03A	300 W	5R5A* <sup>1</sup> or 7R6A* <sup>1</sup>
	SGM7G-05A	450 W	
	SGM7G-09A	850 W	7R6A
SGMMV* <sup>2</sup> (Low inertia, ultra-small capacity), 3,000 min <sup>-1</sup>	SGMMV-A1A	10 W	1R6A* <sup>1</sup> or 2R8A* <sup>1</sup>
	SGMMV-A2A	20 W	
	SGMMV-A3A	30 W	1R6A or 2R8A* <sup>1</sup>

\*1. If you use this combination, performance may not be as good, e.g., the control gain may not increase, in comparison with using a  $\Sigma$ -7S SERVOPACK.

\*2. The SGMMV Servomotor is an older model. When purchasing a new Servomotor, we recommend selecting a SGM7M Servomotor.



Continued from previous page.

Direct Drive Servomotor Model		Rated Torque [N·m]	Instantaneous Maximum Torque [N·m]	SERVOPACK Model
				SGD7W-
SGMCS (Medium Capacity, With Core, Inner Rotor)	SGMCS-45M	45	135	7R6A

\* Use derated values for this combination. Refer to the following catalog for information on derating values.  
 AC Servo Drives Σ-7 Series (Manual No.: KAEP S800001 23)

## 1.5.3 Combinations of Linear Servomotors and SERVOPACKs

Linear Servomotor Model		Rated Force [N]	Instantaneous Maximum Force [N]	SERVOPACK Model
				SGD7W-
SGLG (Coreless), Used with Standard-Force Magnetic Way	SGLGW-30A050C	12.5	40	1R6A
	SGLGW-30A080C	25	80	
	SGLGW-40A140C	47	140	
	SGLGW-40A253C	93	280	
	SGLGW-40A365C	140	420	2R8A
	SGLGW-60A140C	70	220	1R6A
	SGLGW-60A253C	140	440	2R8A
	SGLGW-60A365C	210	660	5R5A
SGLG (Coreless), Used with High-Force Magnetic Way	SGLGW-40A140C	57	230	1R6A
	SGLGW-40A253C	114	460	2R8A
	SGLGW-40A365C	171	690	5R5A
	SGLGW-60A140C	85	360	1R6A
	SGLGW-60A253C	170	720	5R5A
	SGLGW-60A365C	255	1080	7R6A
SGLF (With F-type Iron Cores)	SGLFW-20A090A	25	86	1R6A
	SGLFW-20A120A	40	125	
	SGLFW-35A120A	80	220	
	SGLFW-35A230A	160	440	5R5A
	SGLFW-50A200B	280	600	
	SGLFW2-30A070A	45	135	1R6A
	SGLFW2-30A120A	90	270	
	SGLFW2-30A230A*	180	540	-
		170	500	2R8A
	SGLFW2-45A200A	280	840	5R5A
SGLT (With T-type Iron Cores)	SGLTW-20A170A	130	380	5R5A
	SGLTW-20A320A	250	760	7R6A
	SGLTW-20A460A	380	1140	-
	SGLTW-35A170A	220	660	5R5A
	SGLTW-35A170H	300	600	
	SGLTW-50A170H	450	900	

\* The force depends on the SERVOPACK that is used with the Servomotor.

# 1.6 Functions

This section lists the functions provided by SERVOPACKs. Refer to the reference pages for details on the functions.

- **Functions Related to the Machine**

Function	Reference
Power Supply Type Settings for the Main Circuit and Control Circuit	page 5-13
Automatic Detection of Connected Motor	page 5-15
Motor Direction Setting	page 5-16
Linear Encoder Pitch Setting	page 5-17
Writing Linear Servomotor Parameters	page 5-18
Selecting the Phase Sequence for a Linear Servomotor	page 5-22
Polarity Sensor Setting	page 5-24
Polarity Detection	page 5-25
Overtravel Function and Settings	page 5-28
Holding Brake	page 5-33
Motor Stopping Methods for Servo OFF and Alarms	page 5-38
Resetting the Absolute Encoder	page 5-48
Setting the Origin of the Absolute Encoder	page 5-51
Setting the Regenerative Resistor Capacity	page 5-54
Operation for Momentary Power Interruptions	page 6-17
SEMI F47 Function	page 6-18
Setting the Motor Maximum Speed	page 6-20
Software Limits and Settings	page 6-21
Multiturn Limit Setting	page 6-28
Adjustment of Motor Current Detection Signal Offset	page 6-41
Forcing the Motor to Stop	page 6-45
Speed Ripple Compensation	page 8-62
Current Gain Level Setting	page 8-75
Speed Detection Method Selection	page 8-76
External Latches	-

- **Functions Related to the Host Controller**

Function	Reference
Extended Address Setting	page 5-12
Electronic Gear Settings	page 5-43
I/O Signal Allocations	page 6-3
ALM (Servo Alarm) Signal	page 6-10
/WARN (Warning Output) Signal	page 6-10
/TGON (Rotation Detection) Signal	page 6-11
/S-RDY (Servo Ready) Signal	page 6-12
/V-CMP (Speed Coincidence Detection) Signal	page 6-12
/COIN (Positioning Completion) Signal	page 6-13
/NEAR (Near) Signal	page 6-14
Speed Limit during Torque Control	page 6-15
/LT (Speed Limit Detection) Signal	page 6-15
Selecting Torque Limits	page 6-22

Continued on next page.

Continued from previous page.

Function	Reference
Vibration Detection Level Initialization	page 6-37
Alarm Reset	page 10-38
Replacing the Battery	page 10-3
Setting the Position Deviation Overflow Alarm Level	page 8-8

- **Functions to Achieve Optimum Motions**

Function	Reference
Tuning-less Function	page 8-12
Autotuning without a Host Reference	page 8-24
Autotuning with a Host Reference	page 8-35
Custom Tuning	page 8-43
Anti-Resonance Control Adjustment	page 8-52
Vibration Suppression	page 8-57
Gain Selection	page 8-68
Friction Compensation	page 8-72
Backlash Compensation	page 8-76
Model Following Control	page 8-89
Compatible Adjustment Functions	page 8-92
Mechanical Analysis	page 8-96
Easy FFT	page 8-97

- **Functions for Trial Operation during Setup**

Function	Reference
Software Reset	page 6-34
Trial Operation for the Servomotor without a Load	page 7-7
Program Jogging	page 7-14
Origin Search	page 7-20
Test without a Motor	page 7-23
Monitoring Machine Operation Status and Signal Waveforms	page 9-6

- **Functions for Inspection and Maintenance**

Function	Reference
Write Prohibition Setting for Parameters	page 5-6
Initializing Parameter Settings	page 5-9
Automatic Detection of Connected Motor	page 5-15
Monitoring Product Information	page 9-2
Monitoring Product Life	page 9-2
Alarm History Display	page 10-39
Alarm Tracing	page 9-17

# Selecting a SERVOPACK

# 2

This chapter provides information required to select SERVOPACKs, such as specifications, block diagrams, dimensional drawings, and connection examples.

<b>2.1</b>	<b>Ratings and Specifications . . . . .</b>	<b>2-2</b>
2.1.1	Ratings . . . . .	2-2
2.1.2	SERVOPACK Overload Protection Characteristics . . . . .	2-4
2.1.3	Specifications . . . . .	2-5
<b>2.2</b>	<b>Block Diagrams . . . . .</b>	<b>2-8</b>
2.2.1	SGD7W-1R6A and -2R8A . . . . .	2-8
2.2.2	SGD7W-5R5A and -7R6A . . . . .	2-9
<b>2.3</b>	<b>External Dimensions . . . . .</b>	<b>2-10</b>
2.3.1	Front Cover Dimensions and Connector Specifications . . . . .	2-10
2.3.2	SERVOPACK External Dimensions . . . . .	2-11
<b>2.4</b>	<b>Examples of Standard Connections between SERVOPACKs and Peripheral Devices . .</b>	<b>2-13</b>



## 2.1 Ratings and Specifications

This section gives the ratings and specifications of SERVOPACKs.

### 2.1.1 Ratings

#### Three-Phase, 200 VAC

Model SGD7W-		1R6A	2R8A	5R5A	7R6A	
Maximum Applicable Motor Capacity per Axis [kW]		0.2	0.4	0.75	1.0	
Continuous Output Current per Axis [Arms]		1.6	2.8	5.5	7.6	
Instantaneous Maximum Output Current per Axis [Arms]		5.9	9.3	16.9	17.0	
Main Circuit	Power Supply	200 VAC to 240 VAC, -15% to +10%, 50 Hz/60 Hz				
	Input Current [Arms]*	2.5	4.7	7.8	11	
Control	Power Supply	200 VAC to 240 VAC, -15% to +10%, 50 Hz/60 Hz				
	Input Current [Arms]*	0.25	0.25	0.25	0.25	
Power Supply Capacity [kVA]*		1.0	1.9	3.2	4.5	
Power Loss*	Main Circuit Power Loss [W]	24.0	43.3	78.9	94.2	
	Control Circuit Power Loss [W]	17	17	17	17	
	Built-in Regenerative Resistor Power Loss [W]	8	8	16	16	
	Total Power Loss [W]	49.0	68.3	111.9	127.2	
Regenerative Resistor	Built-In Regenerative Resistor	Resistance [ $\Omega$ ]	40	40	12	12
		Capacity [W]	40	40	60	60
	Minimum Allowable External Resistance [ $\Omega$ ]	40	40	12	12	
Overvoltage Category		III				

\* This is the net value at the rated load.

#### Single-Phase, 200 VAC

Model SGD7W-		1R6A	2R8A	5R5A* <sup>1</sup>	
Maximum Applicable Motor Capacity per Axis [kW]		0.2	0.4	0.75	
Continuous Output Current per Axis [Arms]		1.6	2.8	5.5	
Instantaneous Maximum Output Current per Axis [Arms]		5.9	9.3	16.9	
Main Circuit	Power Supply	200 VAC to 240 VAC, -15% to +10%, 50 Hz/60 Hz			
	Input Current [Arms]* <sup>2</sup>	5.5	11	12	
Control	Power Supply	200 VAC to 240 VAC, -15% to +10%, 50 Hz/60 Hz			
	Input Current [Arms]* <sup>2</sup>	0.25	0.25	0.25	
Power Supply Capacity [kVA]* <sup>2</sup>		1.3	2.4	2.7	
Power Loss* <sup>2</sup>	Main Circuit Power Loss [W]	24.1	43.6	54.1	
	Control Circuit Power Loss [W]	17	17	17	
	Built-in Regenerative Resistor Power Loss [W]	8	8	16	
	Total Power Loss [W]	49.1	68.6	87.1	
Regenerative Resistor	Built-In Regenerative Resistor	Resistance [ $\Omega$ ]	40	40	12
		Capacity [W]	40	40	60
	Minimum Allowable External Resistance [ $\Omega$ ]	40	40	12	
Overvoltage Category		III			

\*1. If you use the SGD7W-5R5A with a single-phase 200-VAC power supply input, derate the load ratio to 65%. An example is given below. If the load ratio of the first axis is 90%, use a load ratio of 40% for the second axis so that average load ratio for both axes is 65%.  
 $((90\% + 40\%)/2 = 65\%)$

\*2. This is the net value at the rated load. However, a load ratio of 65% was used for the SGD7W-5R5A.

## 270 VDC

Model SGD7W-		1R6A	2R8A	5R5A	7R6A
Maximum Applicable Motor Capacity per Axis [kW]		0.2	0.4	0.75	1.0
Continuous Output Current per Axis [Arms]		1.6	2.8	5.5	7.6
Instantaneous Maximum Output Current per Axis [Arms]		5.9	9.3	16.9	17.0
Main Circuit	Power Supply	270 VDC to 324 VDC, -15% to +10%			
	Input Current [Arms]*	3.0	5.8	9.7	14
Control	Power Supply	270 VDC to 324 VDC, -15% to +10%			
	Input Current [Arms]*	0.25	0.25	0.25	0.25
Power Supply Capacity [kVA]*		1.2	2	3.2	4.6
Power Loss*	Main Circuit Power Loss [W]	18.7	33.3	58.4	73.7
	Control Circuit Power Loss [W]	17	17	17	17
	Total Power Loss [W]	35.7	50.3	75.4	90.7
Overvoltage Category		III			

\* This is the net value at the rated load.

## 2.1.2 SERVOPACK Overload Protection Characteristics

The overload detection level is set for hot start conditions with a SERVOPACK surrounding air temperature of 55°C.

An overload alarm (A.710 or A.720) will occur if overload operation that exceeds the overload protection characteristics shown in the following diagram (i.e., operation on the right side of the applicable line) is performed.

The actual overload detection level will be the detection level of the connected SERVOPACK or Servomotor that has the lower overload protection characteristics.

In most cases, that will be the overload protection characteristics of the Servomotor.

- SGD7W-1R6, -2R8

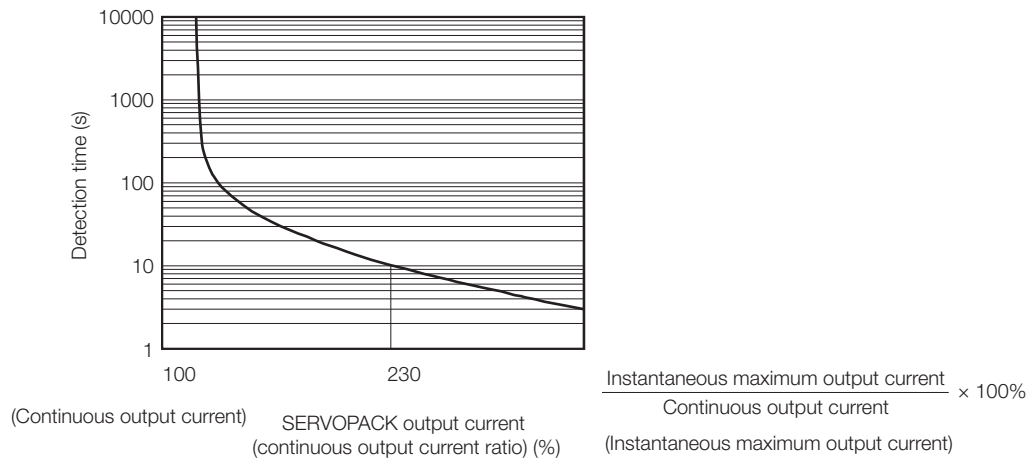

Note: The above overload protection characteristics do not mean that you can perform continuous duty operation with an output of 100% or higher.

For a Yaskawa-specified combination of SERVOPACK and Servomotor, maintain the effective torque within the continuous duty zone of the torque-motor speed characteristic of the Servomotor.

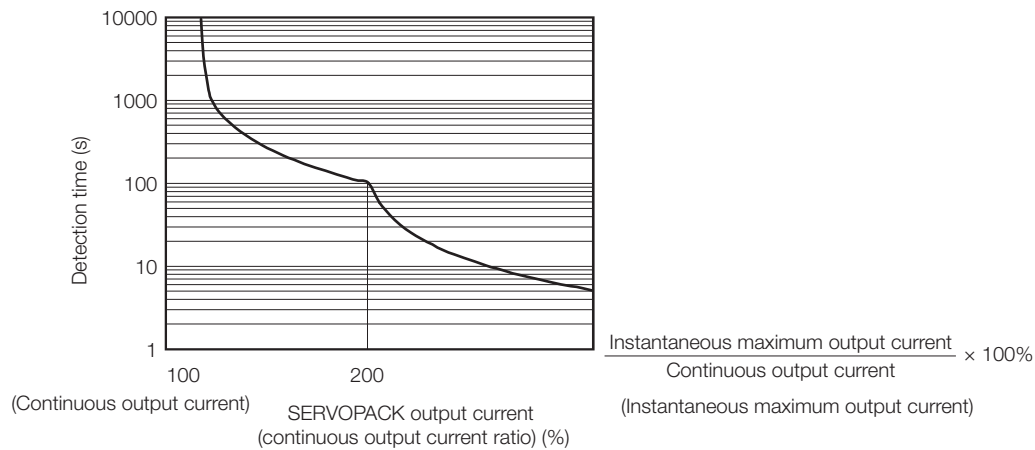

- SGD7W-5R5, -7R6



Note: The above overload protection characteristics do not mean that you can perform continuous duty operation with an output of 100% or higher.

For a Yaskawa-specified combination of SERVOPACK and Servomotor, maintain the effective torque within the continuous duty zone of the torque-motor speed characteristic of the Servomotor.

## 2.1.3 Specifications

Item		Specification
Control Method		IGBT-based PWM control, sine wave current drive
Feedback	With Rotary Servomotor	Serial encoder: 17 bits (absolute encoder) 20 bits or 24 bits (incremental encoder/absolute encoder) 22 bits (absolute encoder)
	With Linear Servomotor	<ul style="list-style-type: none"> <li>Absolute linear encoder (The signal resolution depends on the absolute linear encoder.)</li> <li>Incremental linear encoder (The signal resolution depends on the incremental linear encoder or Serial Converter Unit.)</li> </ul>
Environmental Conditions	Surrounding Air Temperature	-5°C to 55°C (With derating, usage is possible between 55°C and 60°C.) Refer to the following section for derating specifications.  <b>3.6 Derating Specifications on page 3-7</b>
	Storage Temperature	-20°C to 85°C
	Surrounding Air Humidity	95% relative humidity max. (with no freezing or condensation)
	Storage Humidity	95% relative humidity max. (with no freezing or condensation)
	Vibration Resistance	4.9 m/s <sup>2</sup>
	Shock Resistance	19.6 m/s <sup>2</sup>
	Degree of Protection	IP20
	Pollution Degree	2 <ul style="list-style-type: none"> <li>Must be no corrosive or flammable gases.</li> <li>Must be no exposure to water, oil, or chemicals.</li> <li>Must be no dust, salts, or iron dust.</li> </ul>
	Altitude	1,000 m or less. (With derating, usage is possible between 1,000 m and 2,000 m.) Refer to the following section for derating specifications.  <b>3.6 Derating Specifications on page 3-7</b>
	Others	Do not use the SERVOPACK in the following locations: Locations subject to static electricity noise, strong electromagnetic/magnetic fields, or radioactivity
Applicable Standards		Refer to the following section for details.  <b>Compliance with UL Standards and EU Directives on page xxiv</b>
Mounting		Base-mounted or rack-mounted
Performance	Speed Control Range	1:5000 (At the rated torque, the lower limit of the speed control range must not cause the Servomotor to stop.)
	Coefficient of Speed Fluctuation*	±0.01% of rated speed max. (for a load fluctuation of 0% to 100%)
		0% of rated speed max. (for a voltage fluctuation of ±10%)
		±0.1% of rated speed max. (for a temperature fluctuation of 25°C ±25°C)
	Torque Control Precision (Repeatability)	±1%
Soft Start Time Setting	0 s to 10 s (Can be set separately for acceleration and deceleration.)	

Continued on next page.

## 2.1 Ratings and Specifications

### 2.1.3 Specifications

Continued from previous page.

Item		Specification		
I/O Signals	Overheat Protection Input	Number of input points: 2 Input voltage range: 0 V to +5 V		
	Sequence Input Signals	Input Signals That Can Be Allocated	Allowable voltage range: 24 VDC $\pm$ 20% Number of input points: 12 (Input method: Sink inputs or source inputs)  Input Signals <ul style="list-style-type: none"> <li>• P-OT (Forward Drive Prohibit) and N-OT (Reverse Drive Prohibit) signals</li> <li>• /P-CL (Forward External Torque Limit) and /N-CL (Reverse External Torque Limit) signals</li> <li>• /DEC (Origin Return Deceleration Switch) signal</li> <li>• /EXT1 to /EXT3 (External Latch Input 1 to 3) signals</li> <li>• FSTP (Forced Stop Input) signal</li> </ul> A signal can be allocated and the positive and negative logic can be changed.	
		Fixed Output	Output Signals	Allowable voltage range: 5 VDC to 30 VDC Number of output points: 2 (A photocoupler output (isolated) is used.) Output signal: ALM (Servo Alarm) signal
	Sequence Output Signals		Output Signals That Can Be Allocated	Allowable voltage range: 5 VDC to 30 VDC Number of output points: 5 (A photocoupler output (isolated) is used.)  Output Signals <ul style="list-style-type: none"> <li>• /COIN (Positioning Completion) signal</li> <li>• /V-CMP (Speed Coincidence Detection) signal</li> <li>• /TGON (Rotation Detection) signal</li> <li>• /S-RDY (Servo Ready) signal</li> <li>• /CLT (Torque Limit Detection) signal</li> <li>• /VLT (Speed Limit Detection) signal</li> <li>• /BK (Brake) signal</li> <li>• /WARN (Warning) signal</li> <li>• /NEAR (Near) signal</li> </ul> A signal can be allocated and the positive and negative logic can be changed.
		Communications	RS-422A Communications (CN502)	Inter- faces
	1:N Commu- nications			Up to N = 15 stations possible for RS-422A port
Axis Address Settings	03h to EFh (maximum number of slaves: 62) The rotary switches (S1 and S2) are used to set the station address.			
USB Communi- cations (CN7)	Interface		Personal computer (with SigmaWin+)	
	Communi- cations Standard	Conforms to USB2.0 standard (12 Mbps).		
Displays/Indicators		CHARGE, PWR, CN, L1, and L2 indicators, and two, one-digit seven-segment displays		

Continued on next page.

Continued from previous page.

Item		Specification
MECHATROLINK-III Communications	Communications Protocol	MECHATROLINK-III
	Station Address Settings	03h to EFh (maximum number of slaves: 62) The rotary switches (S1 and S2) are used to set the station address.
	Extended Address Setting	Axis A: 00h, Axis B: 01h
	Baud Rate	100 Mbps
	Transmission Cycle	250 $\mu$ s, 500 $\mu$ s, 750 $\mu$ s, 1.0 ms to 4.0 ms (multiples of 0.5 ms)
	Number of Transmission Bytes	32 or 48 bytes per station A DIP switch (S3) is used to select the number of transmission bytes.
Reference Method	Performance	Position, speed, or torque control with MECHATROLINK-III communications
	Reference Input	MECHATROLINK-III commands (sequence, motion, data setting, data access, monitoring, adjustment, etc.)
	Profile	MECHATROLINK-III standard servo profile
MECHATROLINK-III Communications Setting Switches		Rotary switch (S1 and S2) positions: 16
		Number of DIP switch (S3) pins: 4
Analog Monitor (CN5)		Number of points: 2 Output voltage range: $\pm 10$ VDC (effective linearity range: $\pm 8$ V) Resolution: 16 bits Accuracy: $\pm 20$ mV (Typ) Maximum output current: $\pm 10$ mA Settling time ( $\pm 1\%$ ): 1.2 ms (Typ)
Dynamic Brake (DB)		Activated when a servo alarm or overtravel (OT) occurs, or when the power supply to the main circuit or servo is OFF.
Regenerative Processing		Built-in
Overtravel (OT) Prevention		Stopping with dynamic brake, deceleration to a stop, or coasting to a stop for the P-OT (Forward Drive Prohibit) or N-OT (Reverse Drive Prohibit) signal
Protective Functions		Overcurrent, overvoltage, low voltage, overload, regeneration error, etc.
Utility Functions		Gain adjustment, alarm history, jogging, origin search, etc.
Applicable Option Modules		None

\* The coefficient of speed fluctuation for load fluctuation is defined as follows:

$$\text{Coefficient of speed fluctuation} = \frac{\text{No-load motor speed} - \text{Total-load motor speed}}{\text{Rated motor speed}} \times 100\%$$

# 2.2 Block Diagrams

## 2.2.1 SGD7W-1R6A and -2R8A

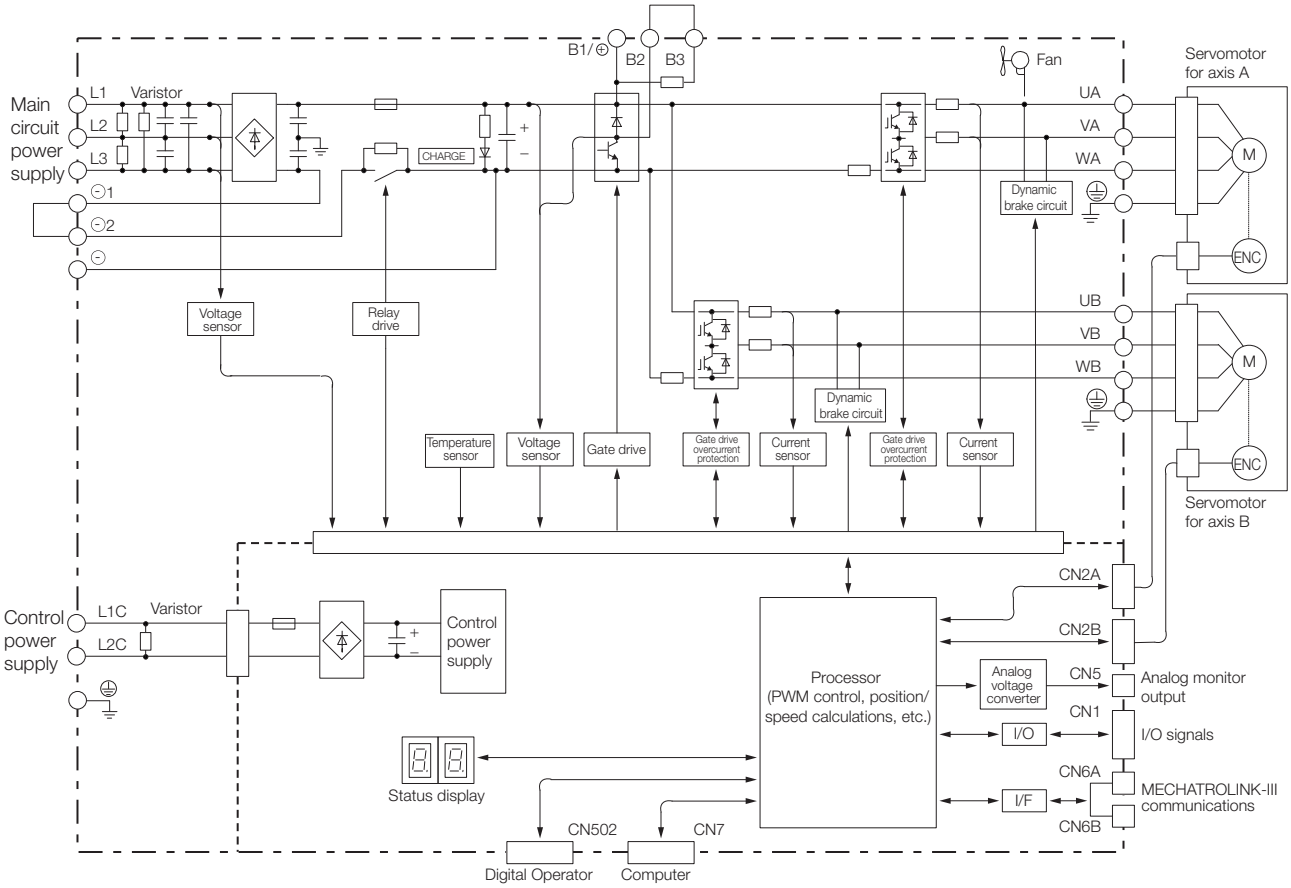

## 2.2.2 SGD7W-5R5A and -7R6A

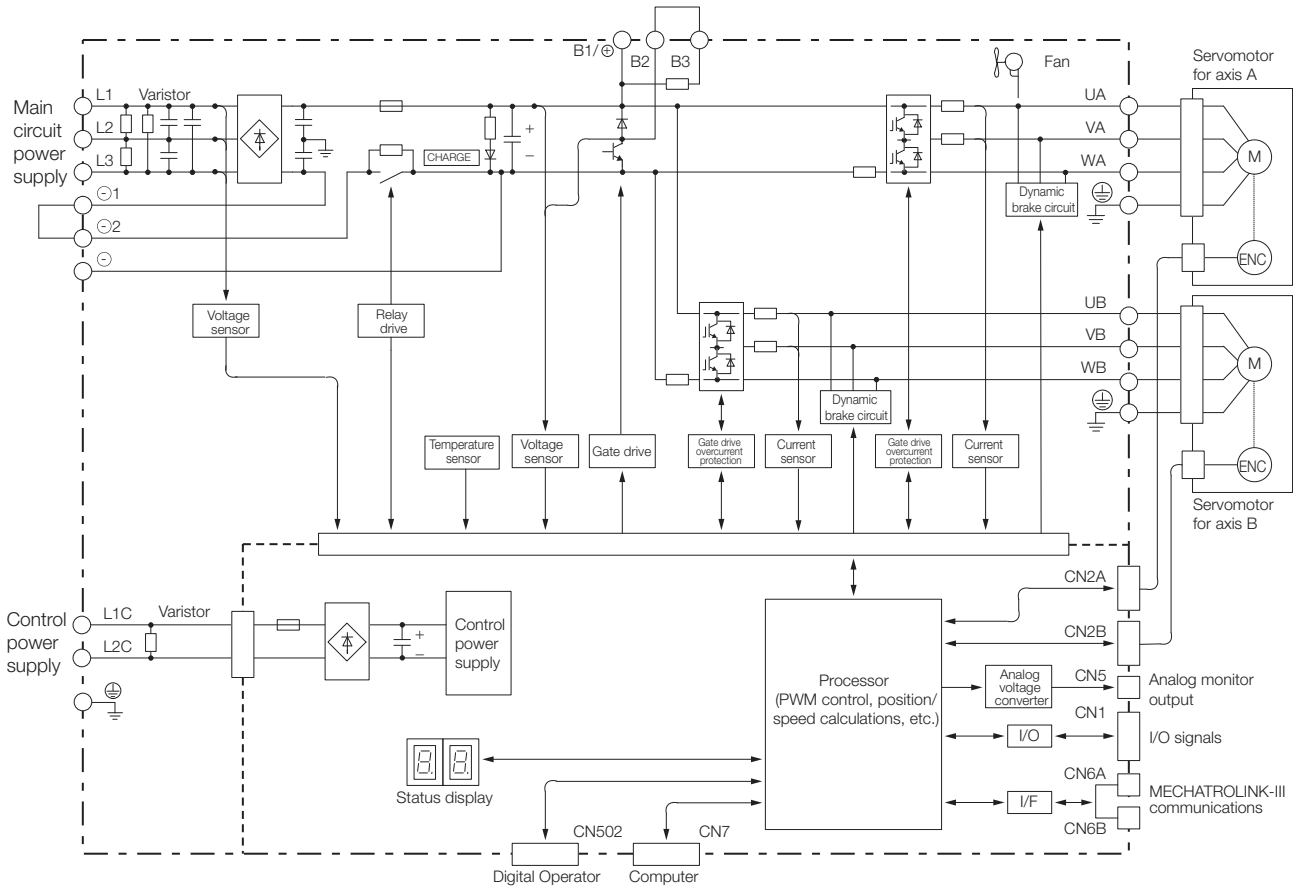



## 2.3 External Dimensions

### 2.3.1 Front Cover Dimensions and Connector Specifications

The front cover dimensions and panel connector section are the same for all models. Refer to the following figures and table.

- Front Cover Dimensions

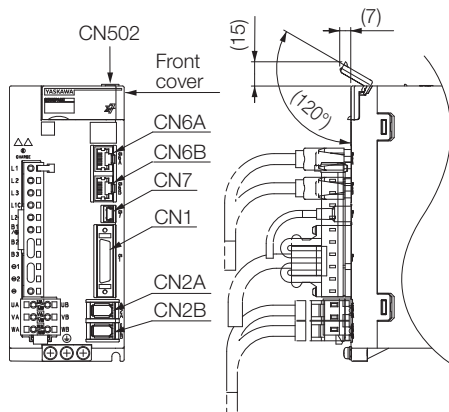

- Connector Specifications

Connector No.	Model	Number of Pins	Manufacturer
CN1	10236-59A3MB	36	3M Japan Limited
CN2A, CN2B	3E106-2230KV	6	3M Japan Limited
CN502	S8B-ZR-SM4A-TF (LF) (SN)	8	J.S.T. Mfg. Co., Ltd.
CN6A, CN6B	1-1734579-4	8	Tyco Electronics Japan G.K.
CN7	2172034-1	5	Tyco Electronics Japan G.K.

Note: The above connectors or their equivalents are used for the SERVOPACKs.

## 2.3.2 SERVOPACK External Dimensions

### Base-mounted SERVOPACKs

- Three-phase, 200 VAC: SGD7W-1R6A and -2R8A

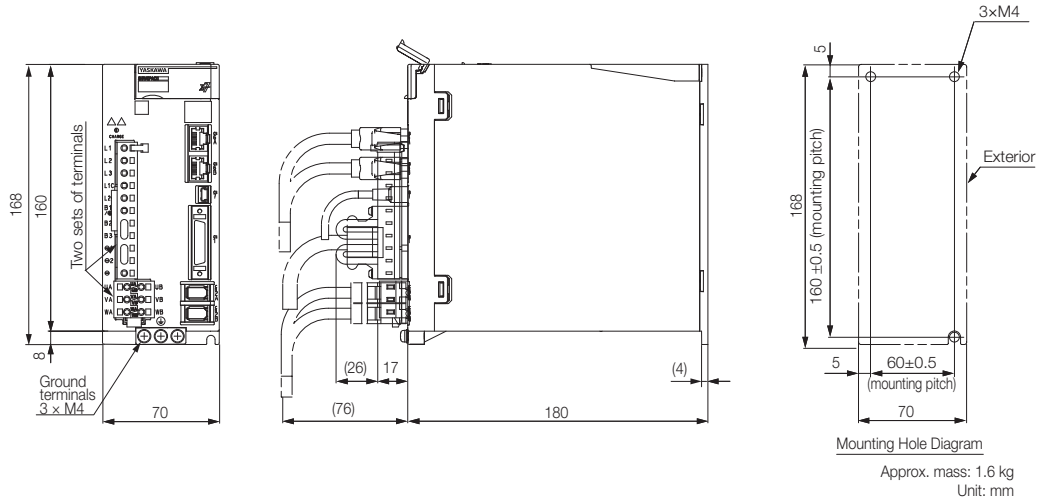

- Three-phase, 200 VAC: SGD7W-5R5A and -7R6A

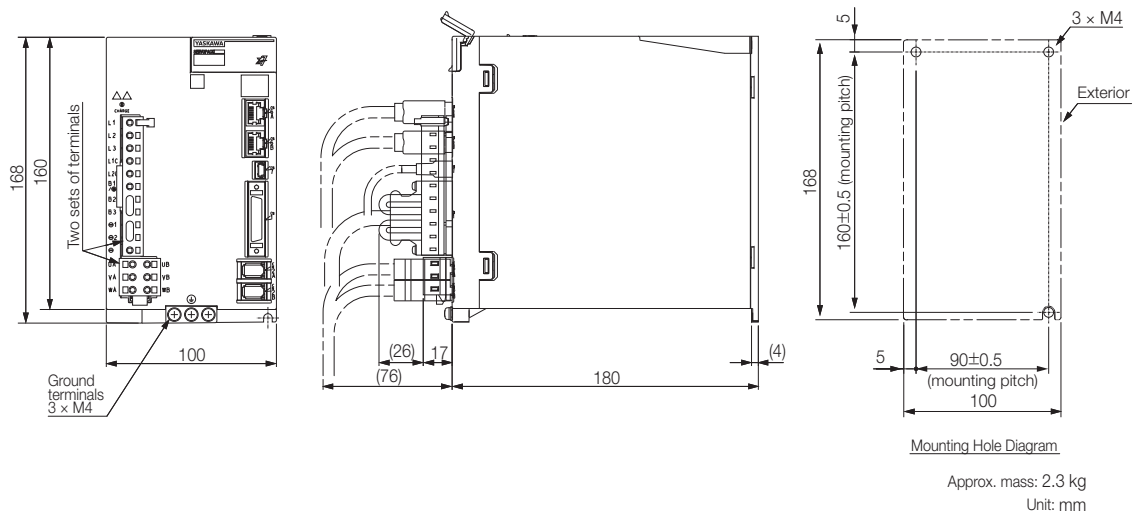

2.3 External Dimensions

2.3.2 SERVOPACK External Dimensions

### Rack-mounted SERVOPACKs

Hardware Option Code: 001

- Three-phase, 200 VAC: SGD7W-1R6A and -2R8A

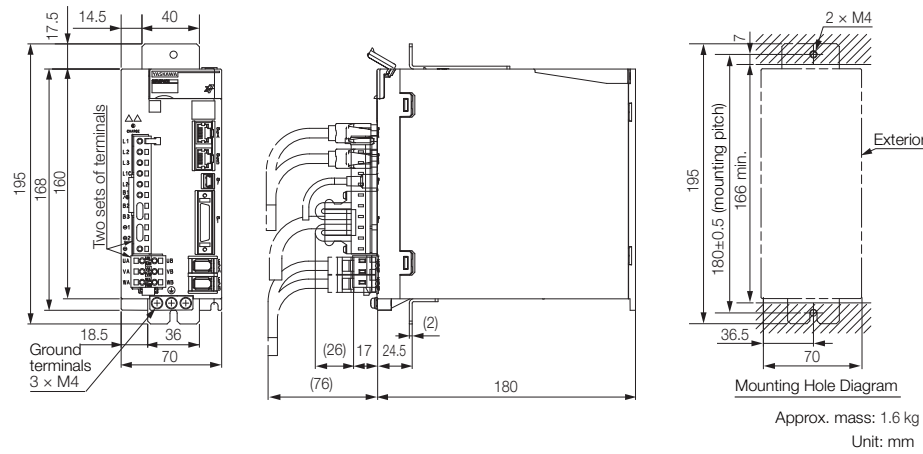

- Three-phase, 200 VAC: SGD7W-5R5A and -7R6A

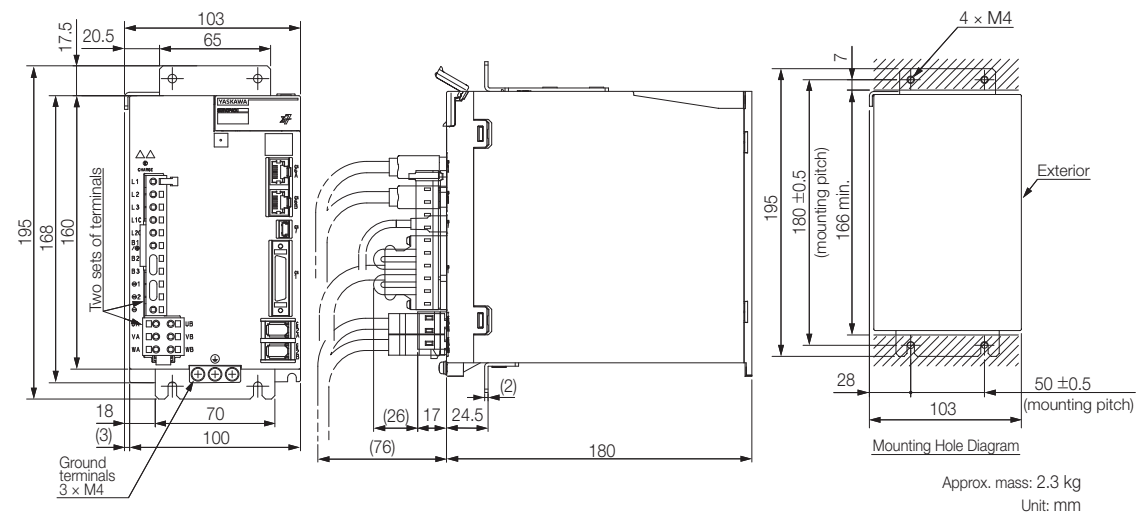

# 2.4

## Examples of Standard Connections between SERVOPACKs and Peripheral Devices

### • Rotary Servomotors

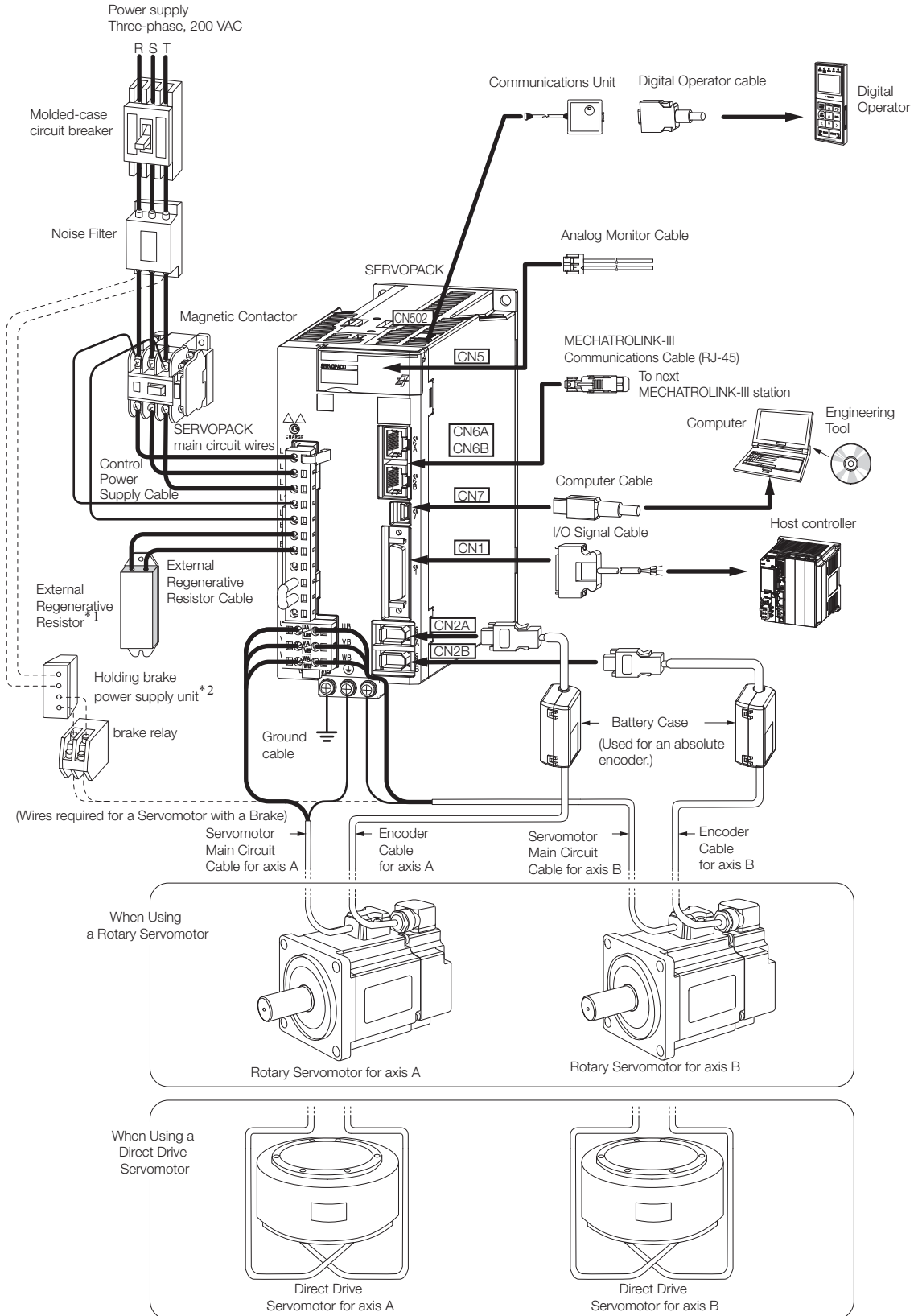

\*1. External Regenerative Resistors are not provided by Yaskawa.  
 \*2. The power supply for the holding brake is not provided by Yaskawa. Select a power supply based on the holding brake specifications. If you use a 24-V brake, install a separate power supply for the 24-VDC power supply from other power supplies, such as the one for the I/O signals of the CN1 connector. If the power supply is shared, the I/O signals may malfunction.

• Linear Servomotors

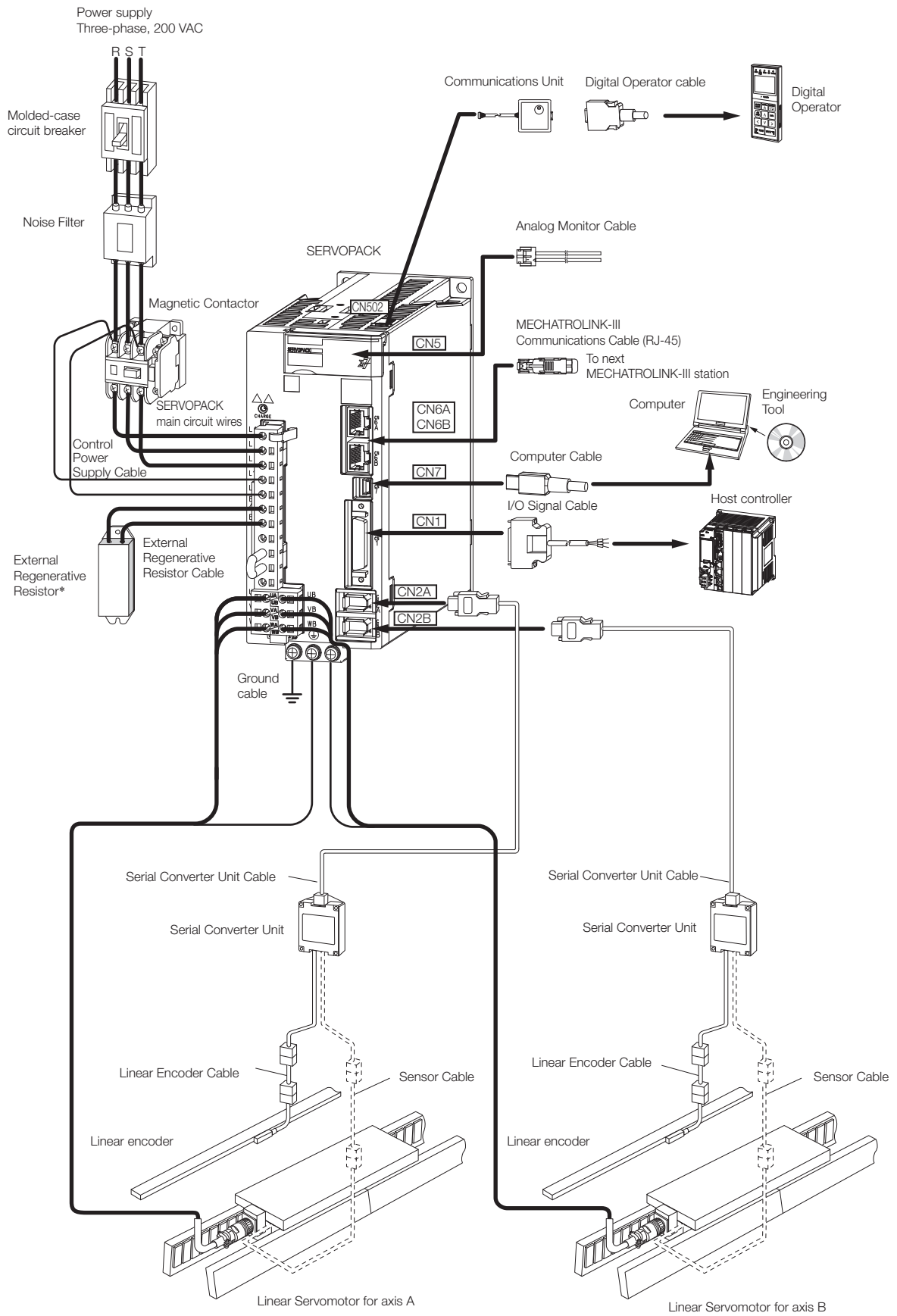

\* External Regenerative Resistors are not provided by Yaskawa.

# SERVOPACK Installation

---

# 3

This chapter provides information on installing SERVOPACKs in the required locations.

<b>3.1</b>	<b>Installation Precautions . . . . .</b>	<b>3-2</b>
<b>3.2</b>	<b>Mounting Types and Orientation . . . . .</b>	<b>3-3</b>
<b>3.3</b>	<b>Mounting Hole Dimensions . . . . .</b>	<b>3-4</b>
<b>3.4</b>	<b>Mounting Interval . . . . .</b>	<b>3-5</b>
	3.4.1 Installing One SERVOPACK in a Control Panel . .	3-5
	3.4.2 Installing More Than One SERVOPACK in a Control Panel . . . . .	3-5
<b>3.5</b>	<b>Monitoring the Installation Environment . . .</b>	<b>3-6</b>
<b>3.6</b>	<b>Derating Specifications . . . . .</b>	<b>3-7</b>
<b>3.7</b>	<b>EMC Installation Conditions . . . . .</b>	<b>3-8</b>

## 3.1 Installation Precautions

Refer to the following section for the ambient installation conditions.

 2.1.3 Specifications on page 2-5

### ■ Installation Near Sources of Heat

Implement measures to prevent temperature increases caused by radiant or convection heat from heat sources so that the ambient temperature of the SERVOPACK meets the ambient conditions.

### ■ Installation Near Sources of Vibration

Install a vibration absorber on the installation surface of the SERVOPACK so that the SERVOPACK will not be subjected to vibration.

### ■ Other Precautions

Do not install the SERVOPACK in a location subject to high temperatures, high humidity, water drops, cutting oil, excessive dust, excessive dirt, excessive iron powder, corrosive gasses, or radioactivity.

# 3.2 Mounting Types and Orientation

The SERVOPACKs come in the following mounting types: base-mounted and rack-mounted types. Regardless of the mounting type, mount the SERVOPACK vertically, as shown in the following figures.

Also, mount the SERVOPACK so that the front panel is facing toward the operator.

Note: Prepare three to four mounting holes for the SERVOPACK and mount it securely in the mounting holes. (The number of mounting holes depends on the capacity of the SERVOPACK.)

- Base-mounted SERVOPACK

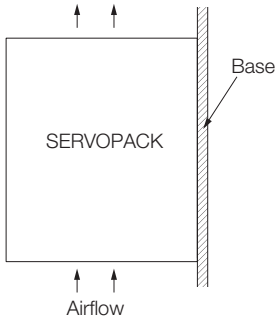

- Rack-mounted SERVOPACK

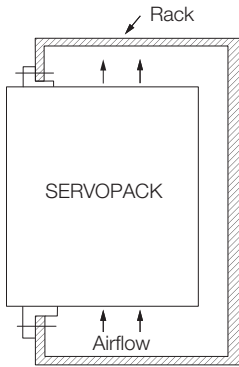



## 3.3 Mounting Hole Dimensions

Use mounting holes to securely mount the SERVOPACK to the mounting surface.

Note: To mount the SERVOPACK, you will need to prepare a screwdriver that is longer than the depth of the SERVOPACK.

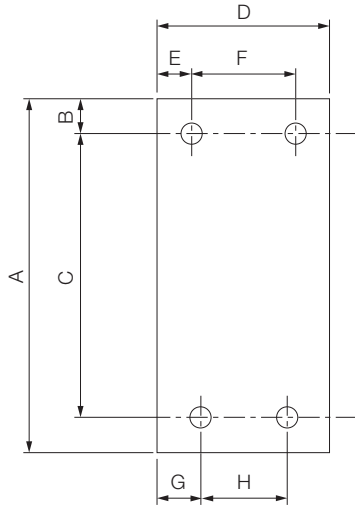

SERVOPACK Model		Dimensions (mm)								Screw Size	Number of Screws
		A	B	C	D	E	F	G	H		
SGD7W-	1R6A, 2R8A	168	5	160 ±0.5	70	5	60 ±0.5	65	-	M4	3
	5R5A, 7R6A	168	5	160 ±0.5	100	5	90 ±0.5	95	-	M4	3

## 3.4 Mounting Interval

### 3.4.1 Installing One SERVOPACK in a Control Panel

Provide the following spaces around the SERVOPACK.

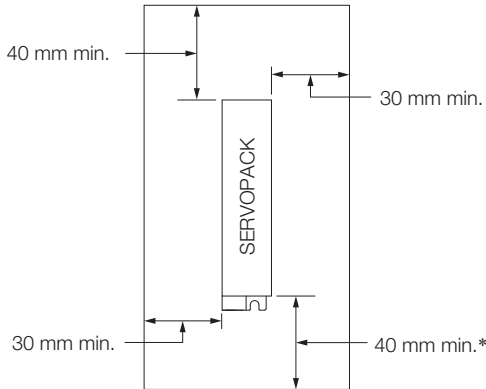

\* For this dimension, ignore items protruding from the main body of the SERVOPACK.

### 3.4.2 Installing More Than One SERVOPACK in a Control Panel

Provide the following intervals between the SERVOPACKs and spaces around the SERVOPACKs.



Install cooling fans above the SERVOPACKs so that hot spots do not occur around the SERVOPACKs. Provide sufficient intervals and spaces as shown in the following figure to enable cooling by the fans and natural convection.

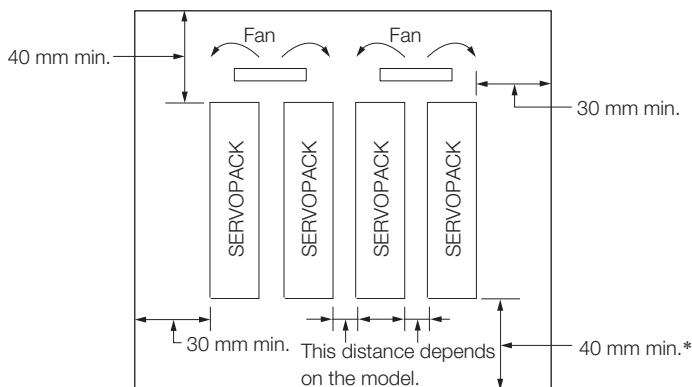

\* For this dimension, ignore items protruding from the main body of the SERVOPACK.

The space required on the right side of a SERVOPACK (when looking at the SERVOPACK from the front) depends on the SERVOPACK models. Refer to the following table.

SERVOPACK Model	Space on Right Side	Cooling Fan Installation Conditions
		10 mm above SERVOPACK's Top Surface
SGD7W-1R6A, -2R8A, -5R5A, or -7R6A	5 mm min.	Air speed: 0.5 m/s min.

## 3.5 Monitoring the Installation Environment

You can use the SERVOPACK Installation Environment Monitor parameter to check the operating conditions of the SERVOPACK in the installation environment.

You can check the SERVOPACK installation environment monitor with either of the following methods.

- Using the SigmaWin+: **Life Monitor - Installation Environment Monitor - SERVOPACK**
- Digital Operator: Un025 (Installation Environment Monitor [%])

Implement one or more of the following actions if the monitor value exceeds 100%.

- Lower the surrounding temperature.
- Decrease the load.

**Information** The value of the SERVOPACK Installation Environment Monitor parameter will increase by about 10% for each 10°C increase in the ambient temperature.



Important

Always observe the surrounding air temperature given in the SERVOPACK environment conditions. Even if the monitor value is 100% or lower, you cannot use a SERVOPACK in a location that exceeds the specified surrounding air temperature.

# 3.6 Derating Specifications

If you use the SERVOPACK at a surrounding air temperature of 55°C to 60°C or at an altitude of 1,000 m to 2,000 m, you must apply the derating rates given in the following graphs.

- SGD7W-1R6A, -2R8A, -5R5A, or -7R6A

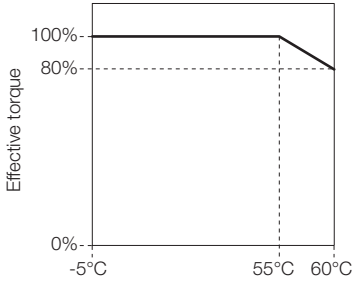

Surrounding air temperature

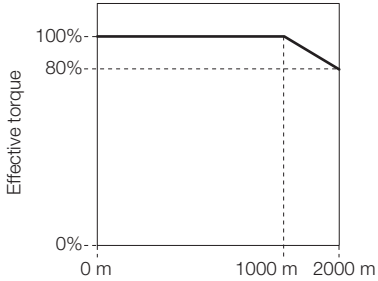

Altitude

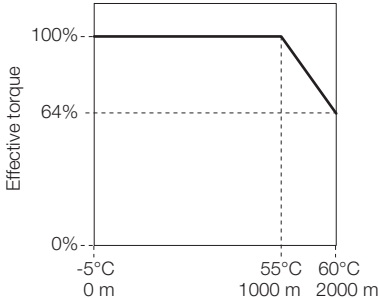

Surrounding air temperature and altitude

# 3.7 EMC Installation Conditions

This section gives the installation conditions that were used for EMC certification testing.

The EMC installation conditions that are given here are the conditions that were used to pass testing criteria at Yaskawa. The EMC level may change under other conditions, such as the actual installation structure and wiring conditions. These Yaskawa products are designed to be built into equipment. Therefore, you must implement EMC measures and confirm compliance for the final equipment.

The applicable standards are EN 55011 group 1 class A, EN 61000-6-2, EN 61000-6-4, and EN 61800-3 (category C2, second environment).

- Three-Phase, 200 VAC

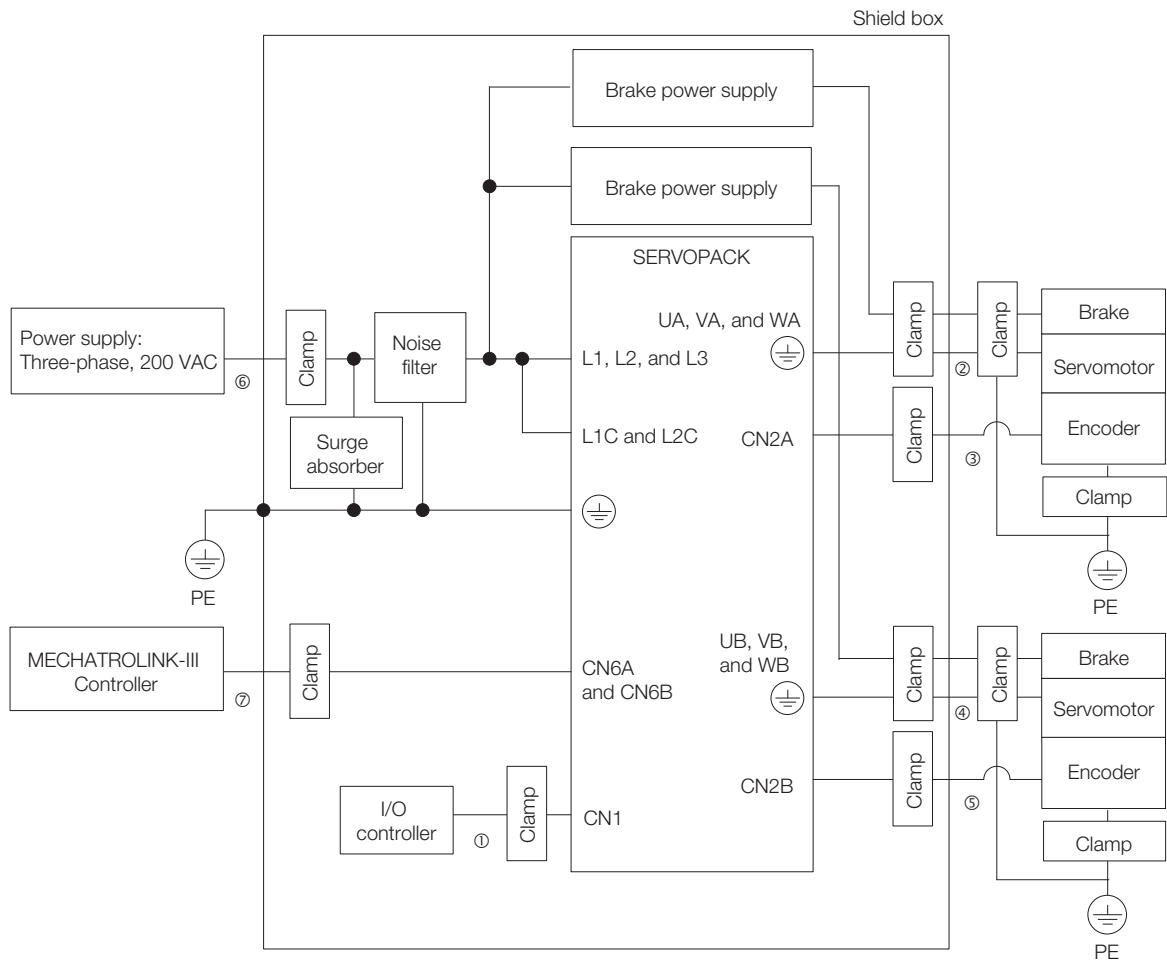

Symbol	Cable Name	Specification
①	I/O Signal Cable	Shielded cable
②	Motor Main Circuit Cable for axis A	Shielded cable
③	Encoder Cable for axis A	Shielded cable
④	Motor Main Circuit Cable for axis B	Shielded cable
⑤	Encoder Cable for axis B	Shielded cable
⑥	Main Circuit Power Cable	Shielded cable
⑦	MECHATROLINK-III Communications Cable (RJ-45)	Shielded cable

- Single-Phase, 200 VAC

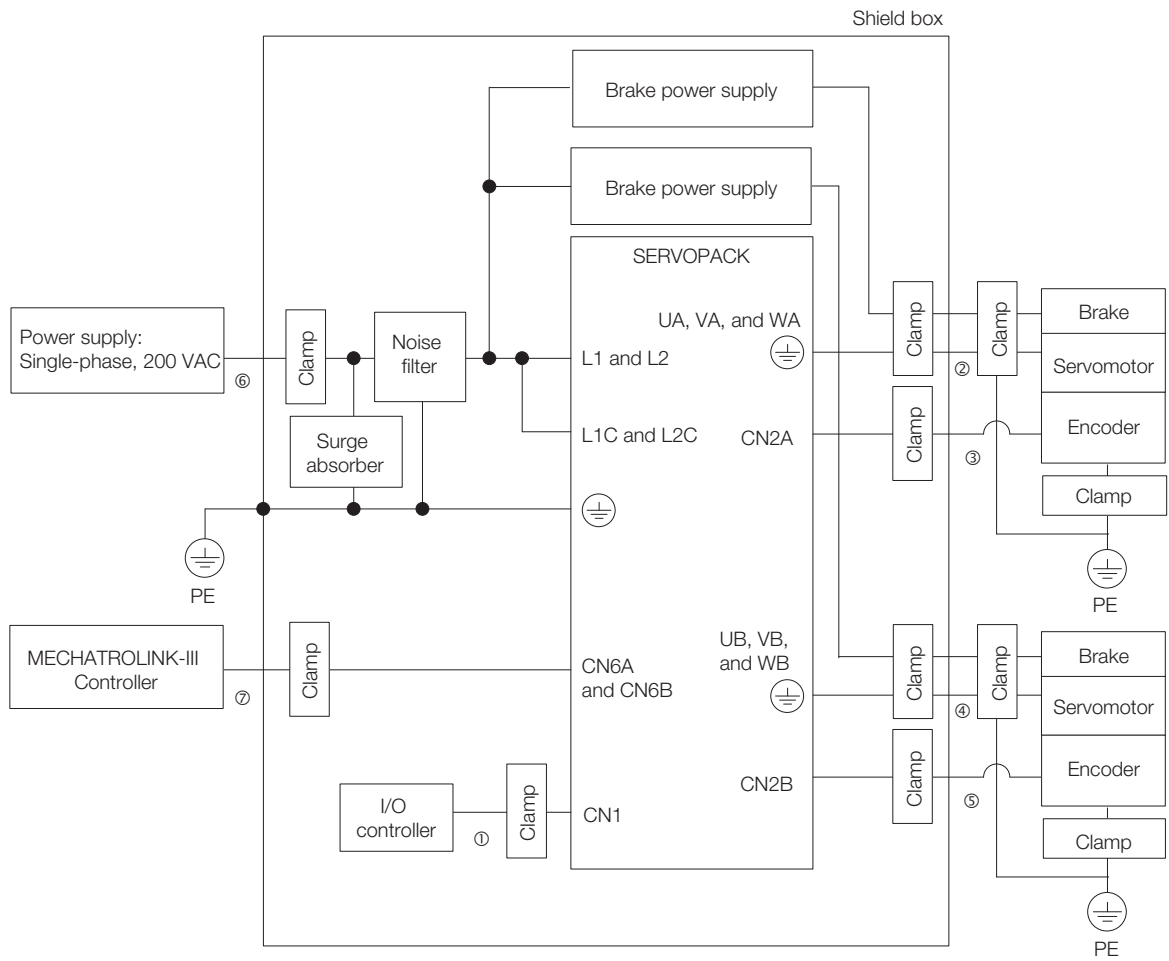

Symbol	Cable Name	Specification
①	I/O Signal Cable	Shielded cable
②	Motor Main Circuit Cable for axis A	Shielded cable
③	Encoder Cable for axis A	Shielded cable
④	Motor Main Circuit Cable for axis B	Shielded cable
⑤	Encoder Cable for axis B	Shielded cable
⑥	Main Circuit Power Cable	Shielded cable
⑦	MECHATROLINK-III Communications Cable (RJ-45)	Shielded cable

# Wiring and Connecting SERVOPACKs

# 4

This chapter provides information on wiring and connecting SERVOPACKs to power supplies and peripheral devices.

<b>4.1</b>	<b>Wiring and Connecting SERVOPACKs . . . .</b>	<b>4-3</b>
4.1.1	General Precautions . . . . .	4-3
4.1.2	Countermeasures against Noise . . . . .	4-6
4.1.3	Grounding . . . . .	4-9
<b>4.2</b>	<b>Basic Wiring Diagrams . . . . .</b>	<b>4-10</b>
<b>4.3</b>	<b>Wiring the Power Supply to the SERVOPACK . .</b>	<b>4-11</b>
4.3.1	Terminal Symbols and Terminal Names . . . . .	4-11
4.3.2	Wiring Procedure for Main Circuit Connector . .	4-12
4.3.3	Power ON Sequence . . . . .	4-14
4.3.4	Power Supply Wiring Diagrams . . . . .	4-15
4.3.5	Wiring Regenerative Resistors . . . . .	4-19
4.3.6	Wiring Reactors for Harmonic Suppression . . . .	4-20
<b>4.4</b>	<b>Wiring Servomotors . . . . .</b>	<b>4-21</b>
4.4.1	Terminal Symbols and Terminal Names . . . . .	4-21
4.4.2	Pin Arrangement of Encoder Connectors (CN2A and CN2B) . . . . .	4-21
4.4.3	Wiring the SERVOPACK to the Encoder . . . . .	4-22
4.4.4	Wiring the SERVOPACK to the Holding Brake . .	4-31
<b>4.5</b>	<b>I/O Signal Connections . . . . .</b>	<b>4-33</b>
4.5.1	I/O Signal Connector (CN1) Names and Functions . . . . .	4-33
4.5.2	I/O Signal Connector (CN1) Pin Arrangement . .	4-35
4.5.3	I/O Signal Wiring Examples . . . . .	4-36
4.5.4	I/O Circuits . . . . .	4-38

**4.6** Connecting MECHATROLINK-III Communications Cables (RJ-45) . . 4-40

**4.7** Connecting the Other Connectors . . . . .4-41

4.7.1 Serial Communications Connector (CN502) . . . .4-41

4.7.2 Computer Connector (CN7) . . . . .4-41

4.7.3 Analog Monitor Connector (CN5) . . . . .4-42



## 4.1 Wiring and Connecting SERVOPACKs

### 4.1.1 General Precautions



#### DANGER

- Do not change any wiring while power is being supplied.  
There is a risk of electric shock or injury.



#### WARNING

- Wiring and inspections must be performed only by qualified engineers.  
There is a risk of electric shock or product failure.
- Check all wiring and power supplies carefully.  
Incorrect wiring or incorrect voltage application to the output circuits may cause short-circuit failures. If a short-circuit failure occurs as a result of any of these causes, the holding brake will not work. This could damage the machine or cause an accident that may result in death or injury.
- Connect the AC and DC power supplies to the specified SERVOPACK terminals.
  - Connect an AC power supply to the L1, L2, and L3 terminals and the L1C and L2C terminals on the SERVOPACK.
  - Connect a DC power supply to the B1/⊕ and ⊖2 terminals and the L1C and L2C terminals on the SERVOPACK.  
There is a risk of failure or fire.
- If you use a SERVOPACK with the Dynamic Brake Hardware Option, connect an External Dynamic Brake Resistor that is suitable for the machine and equipment specifications to the specified terminals.  
There is a risk of unexpected operation, machine damage, burning, or injury when an emergency stop is performed.

## CAUTION

- Wait for six minutes after turning OFF the power supply and then make sure that the CHARGE indicator is not lit before starting wiring or inspection work. Do not touch the power supply terminals while the CHARGE lamp is lit after turning OFF the power supply because high voltage may still remain in the SERVOPACK.  
There is a risk of electric shock.
- Observe the precautions and instructions for wiring and trial operation precisely as described in this document.  
Failures caused by incorrect wiring or incorrect voltage application in the brake circuit may cause the SERVOPACK to fail, damage the equipment, or cause an accident resulting in death or injury.
- Check the wiring to be sure it has been performed correctly.  
Connectors and pin layouts are sometimes different for different models. Always confirm the pin layouts in technical documents for your model before operation.  
There is a risk of failure or malfunction.
- Connect wires to power supply terminals and motor connection terminals securely with the specified methods and tightening torque.  
Insufficient tightening may cause wires and terminal blocks to generate heat due to faulty contact, possibly resulting in fire.
- Use shielded twisted-pair cables or screened unshielded multi-twisted-pair cables for I/O Signal Cables and Encoder Cables.
- Observe the following precautions when wiring the SERVOPACK's main circuit terminals.
  - Turn ON the power supply to the SERVOPACK only after all wiring, including the main circuit terminals, has been completed.
  - If a connector is used for the main circuit terminals, remove the main circuit connector from the SERVOPACK before you wire it.
  - Insert only one wire per insertion hole in the main circuit terminals.
  - When you insert a wire, make sure that the conductor wire (e.g., whiskers) does not come into contact with adjacent wires.
- Install molded-case circuit breakers and other safety measures to provide protection against short circuits in external wiring.  
There is a risk of fire or failure.

## NOTICE

- Whenever possible, use the Cables specified by Yaskawa.  
If you use any other cables, confirm the rated current and application environment of your model and use the wiring materials specified by Yaskawa or equivalent materials.
- Securely tighten cable connector screws and lock mechanisms.  
Insufficient tightening may result in cable connectors falling off during operation.
- Do not bundle power lines (e.g., the Main Circuit Cable) and low-current lines (e.g., the I/O Signal Cables or Encoder Cables) together or run them through the same duct. If you do not place power lines and low-current lines in separate ducts, separate them by at least 30 cm. If the cables are too close to each other, malfunctions may occur due to noise affecting the low-current lines.
- Install a battery at either the host controller or on the Encoder Cable.  
If you install batteries both at the host controller and on the Encoder Cable at the same time, you will create a loop circuit between the batteries, resulting in a risk of damage or burning.
- When connecting a battery, connect the polarity correctly.  
There is a risk of battery rupture or encoder failure.



Important

- Use a molded-case circuit breaker or fuse to protect the main circuit. The SERVOPACK connects directly to a commercial power supply; it is not isolated through a transformer or other device. Always use a molded-case circuit breaker or fuse to protect the servo system from accidents involving different power system voltages or other accidents.
- Install an earth leakage breaker. The SERVOPACK does not have a built-in ground fault protective circuit. To configure a safer system, install a ground fault detector against overloads and short-circuiting, or install a ground fault detector combined with a molded-case circuit breaker.
- Do not turn the power supply ON and OFF more than necessary.
  - Do not use the SERVOPACK for applications that require the power supply to turn ON and OFF frequently. Such applications will cause elements in the SERVOPACK to deteriorate.
  - After you have started actual operation, allow at least one hour between turning the power supply ON and OFF (as a guideline).

To ensure safe, stable application of the servo system, observe the following precautions when wiring.

- Use the cables specified by Yaskawa. Design and arrange the system so that each cable is as short as possible.

Refer to the following manual or catalog for information on the specified cables.

 AC Servo Drives  $\Sigma$ -7 Series (Catalog No.: KAEP S800001 23)

  $\Sigma$ -7-Series Peripheral Device Selection Manual (Manual No.: SIEP S800001 32)

- The signal cable conductors are as thin as  $0.2 \text{ mm}^2$  or  $0.3 \text{ mm}^2$ . Do not subject them to excessive bending stress or tension.

---

## 4.1.2 Countermeasures against Noise

---



Important

The SERVOPACK is designed as an industrial device. It therefore provides no measures to prevent radio interference. The SERVOPACK uses high-speed switching elements in the main circuit. Therefore peripheral devices may be affected by switching noise.

If the equipment is to be used near private houses or if radio interference is a problem, take countermeasures against noise.

The SERVOPACK uses microprocessors. Therefore, it may be affected by switching noise from peripheral devices.

To prevent the noise from the SERVOPACK or the peripheral devices from causing malfunctions of any devices, take the following countermeasures against noise as required.

- Install the input reference device and Noise Filter as close to the SERVOPACK as possible.
- Always install a Surge Absorber for relays, solenoids, and Magnetic Contactor coils.
- Do not place the following cables in the same duct or bundle them together. Also, separate the cables from each other by at least 30 cm.
  - Main Circuit Cables and I/O Signal Cables
  - Main Circuit Cables and Encoder Cables
- Do not share the power supply with an electric welder or electrical discharge machine. If the SERVOPACK is placed near a high-frequency generator, install Noise Filters on the input side on the Main Circuit Power Supply Cable and Control Power Supply Cable even if the same power supply is not shared with the high-frequency generator. Refer to the following section for information on connecting Noise Filters.

 *Noise Filters on page 4-7*

- Implement suitable grounding measures. Refer to the following section for information on grounding measures.

 *4.1.3 Grounding on page 4-9*



## Noise Filter Wiring and Connection Precautions

Always observe the following precautions when wiring or connecting Noise Filters.

- Separate input lines from output lines. Do not place input lines and output lines in the same duct or bundle them together.

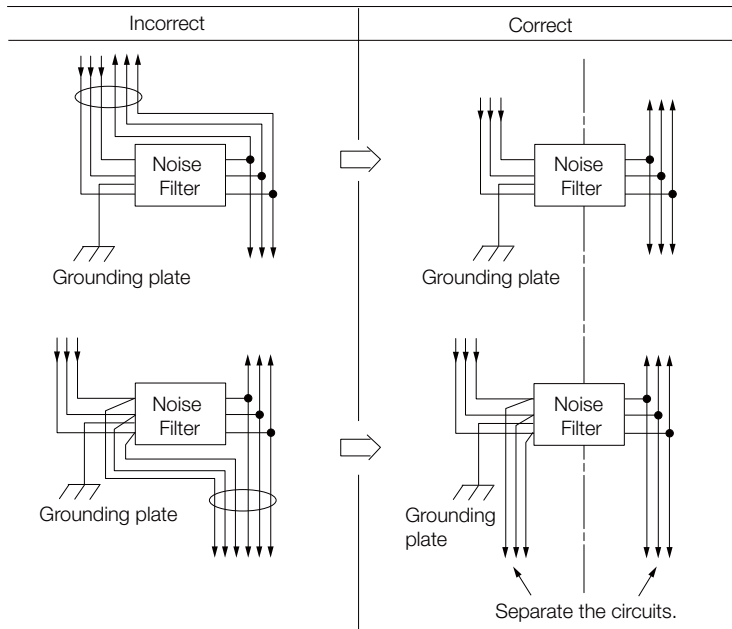

- Separate the Noise Filter ground wire from the output lines. Do not place the Noise Filter ground wire, output lines, and other signal lines in the same duct or bundle them together.

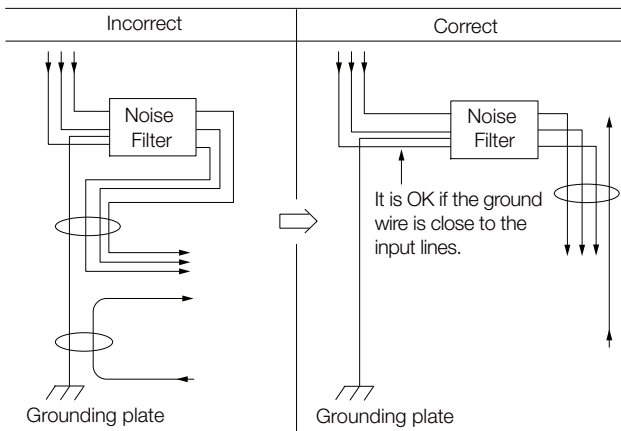

- Connect the Noise Filter ground wire directly to the grounding plate. Do not connect the Noise Filter ground wire to other ground wires.

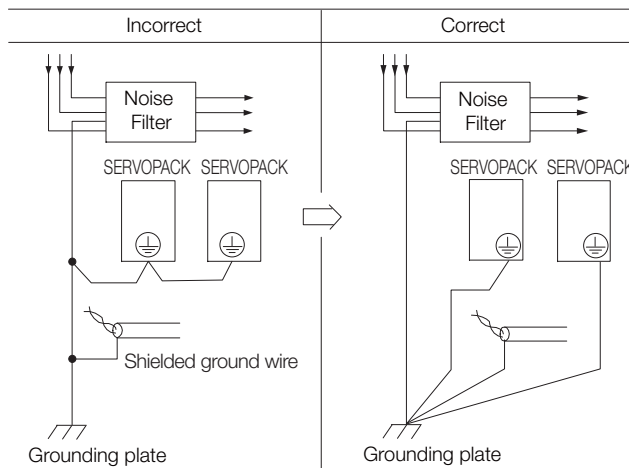

- If a Noise Filter is located inside a control panel, first connect the Noise Filter ground wire and the ground wires from other devices inside the control panel to the grounding plate for the control panel, then ground the plate.

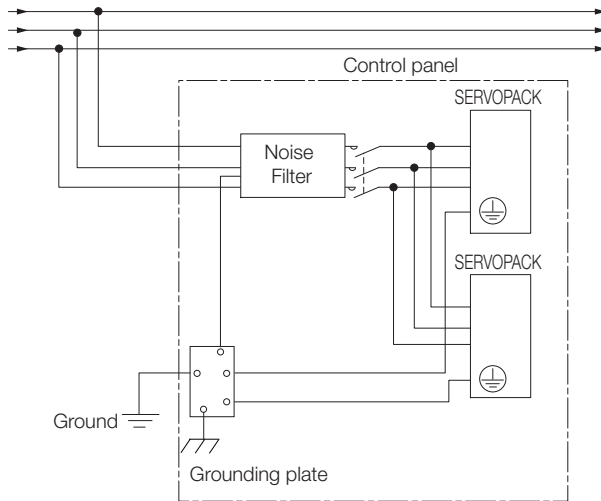

## 4.1.3 Grounding

Implement grounding measures as described in this section. Implementing suitable grounding measures will also help prevent malfunctions, which can be caused by noise.

Observe the following precautions when wiring the ground cable.

- Ground the SERVOPACK to a resistance of 100  $\Omega$  or less.
- Be sure to ground at one point only.
- Ground the Servomotor directly if the Servomotor is insulated from the machine.

### Motor Frame Ground or Motor Ground

If you ground the Servomotor through the machine, switching noise current can flow from the main circuit of the SERVOPACK through the stray capacitance of the Servomotor. To prevent this, always connect the FG terminal of the Servomotor Main Circuit Cable connected to the Servomotor to the ground terminal (⊕) on the SERVOPACK. Also be sure to ground the ground terminal (⊕). Always connect the shield wire of the Encoder Cable connected to the Servomotor to the connector case (shell).

Ground both the Moving Coil and Magnetic Way of a Linear Servomotor.

### Noise on I/O Signal Cables

If noise enters the I/O Signal Cable, connect the shield of the I/O Signal Cable to the connector shell to ground it. If the Servomotor Main Circuit Cable is placed in a metal conduit, ground the conduit and its junction box. For all grounding, ground at one point only.

# 4.2 Basic Wiring Diagrams

This section provide the basic wiring diagrams. Refer to the reference sections given in the diagrams for details.

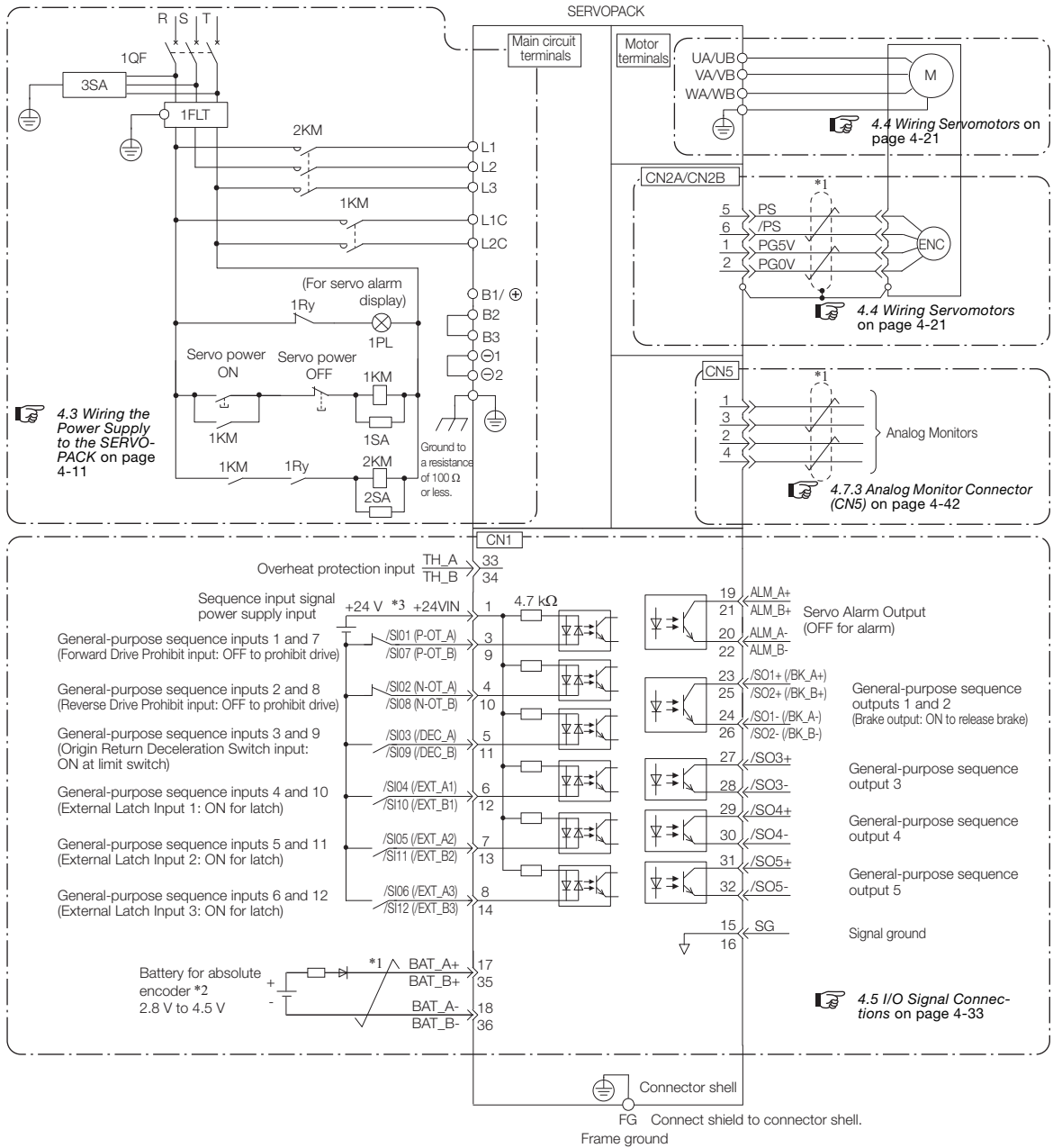

- \*1. represents twisted-pair wires.
- \*2. Connect these when using an absolute encoder. If the Encoder Cable with a Battery Case is connected, do not connect a backup battery.
- \*3. The 24-VDC power supply is not provided by Yaskawa. Use a 24-VDC power supply with double insulation or reinforced insulation.

Note: 1. You can use parameter settings to change some of the I/O signal allocations. Refer to the following section for details.

**6.1 I/O Signal Allocations on page 6-3**

2. If you use a 24-V brake, install a separate power supply for the 24-VDC power supply from other power supplies, such as the one for the I/O signals of the CN1 connector. If the power supply is shared, the I/O signals may malfunction.
3. Default settings are given in parentheses.





## 4.3

## Wiring the Power Supply to the SERVOPACK

## 4.3.1 Terminal Symbols and Terminal Names

Refer to the following manual or catalog for information on cables and peripheral devices.

 AC Servo Drives  $\Sigma$ -7 Series (Catalog No.: KAEP S800001 23)

  $\Sigma$ -7-Series Peripheral Device Selection Manual (Manual No.: SIEP S800001 32)



 **CAUTION**

- Wire all connections correctly according to the following table and specified reference information. There is a risk of SERVOPACK failure or fire if incorrect wiring is performed.

The SERVOPACKs have the following three types of main circuit power supply input specifications.

**Information** A single-phase AC power supply or a DC power supply can be connected to the control power supply terminals.

- Three-Phase, 200-VAC Power Supply Input



Terminal Symbols	Terminal Name	Specifications and Reference	
L1, L2, L3	Main circuit power supply input terminals for AC power supply input	Three-phase, 200 VAC to 240 VAC, -15% to +10%, 50 Hz/60 Hz	
L1C, L2C	Control power supply terminals	AC power supply	Single-phase, 200 VAC to 240 VAC, -15% to +10%, 50 Hz/60 Hz
		DC power supply	L1C: 270 VDC to 324 VDC, -15% to +10%, L2C: 0 VDC or L2C: 270 VDC to 324 VDC, -15% to +10%, L1C: 0 VDC
B1/⊕, B2, B3	Regenerative Resistor terminals	 <b>4.3.5 Wiring Regenerative Resistors on page 4-19</b> If the internal regenerative resistor is insufficient, remove the lead or short bar between B2 and B3 and connect an External Regenerative Resistor between B1/⊕ and B2. The External Regenerative Resistor is not included. Purchase it separately.	
⊖1, ⊖2	DC Reactor terminals for power supply harmonic suppression	 <b>4.3.6 Wiring Reactors for Harmonic Suppression on page 4-20</b> These terminals are used to connect a DC Reactor for power supply harmonic suppression or power factor improvement.	
⊖	–	None. (Do not connect anything to this terminal.)	

- Single-Phase, 200-VAC Power Supply Input

Terminal Symbols	Terminal Name	Specifications and Reference	
L1, L2	Main circuit power supply input terminals for AC power supply input	Single-phase, 200 VAC to 240 VAC, -15% to +10%, 50 Hz/60 Hz	
L1C, L2C	Control power supply terminals	AC power supply	Single-phase, 200 VAC to 240 VAC, -15% to +10%, 50 Hz/60 Hz
		DC power supply	L1C: 270 VDC to 324 VDC, -15% to +10%, L2C: 0 VDC or L2C: 270 VDC to 324 VDC, -15% to +10%, L1C: 0 VDC

Continued on next page.

Continued from previous page.

Terminal Symbols	Terminal Name	Specifications and Reference
B1/⊕, B2, B3	Regenerative Resistor terminals	 <b>4.3.5 Wiring Regenerative Resistors on page 4-19</b> If the internal regenerative resistor is insufficient, remove the lead or short bar between B2 and B3 and connect an External Regenerative Resistor between B1/⊕ and B2. The External Regenerative Resistor is not included. Obtain it separately.
⊖1, ⊖2	DC Reactor terminals for power supply harmonic suppression	 <b>4.3.6 Wiring Reactors for Harmonic Suppression on page 4-20</b> These terminals are used to connect a DC Reactor for power supply harmonic suppression or power factor improvement.
L3, ⊖	–	None. (Do not connect anything to these terminals.)

You can use a single-phase, 200-V power supply input with the following models.

- SGD7W-1R6A, -2R8A, or -5R5A

If you use a single-phase, 200-VAC power supply input for the SERVOPACK's main circuit power supply, set parameter Pn00B to n.□1□□ (Use a three-phase power supply input as a single-phase power supply input). Refer to the following section for details.

 **5.3.2 Single-phase AC Power Supply Input/Three-phase AC Power Supply Input Setting on page 5-14**

• DC Power Supply Input

Terminal Symbols	Terminal Name	Specifications and Reference	
L1C, L2C	Control power supply terminals	AC power supply	Single-phase, 200 VAC to 240 VAC, -15% to +10%, 50 Hz/60 Hz
		DC power supply	L1C: 270 VDC to 324 VDC, -15% to +10%, L2C: 0 VDC or L2C: 270 VDC to 324 VDC, -15% to +10%, L1C: 0 VDC
B1/⊕	Main circuit power supply input terminals for DC power supply input	270 VDC to 324 VDC, -15% to +10%	
⊖2		0 VDC	
L1, L2, L3, B2, B3, ⊖1, ⊖	–	None. (Do not connect anything to these terminals.)	

If you use a DC power supply input to the SERVOPACK, make sure to set parameter Pn00E to n.□□□1 (DC power supply input supported) before inputting the power supply. Refer to the following section for details.

 **5.3.1 AC Power Supply Input/DC Power Supply Input Setting on page 5-13**

## 4.3.2 Wiring Procedure for Main Circuit Connector

• Required Items

Required Item	Remarks
Spring Opener or Flat-blade Screwdriver	<ul style="list-style-type: none"> <li>• Spring Opener SERVOPACK accessory (You can also use model 1981045-1 from Tyco Electronics Japan G.K.)</li> </ul>
	<ul style="list-style-type: none"> <li>• Flat-blade screwdriver Commercially available screwdriver with tip width of 3.0 mm to 3.5 mm</li> </ul>

1. Remove the main circuit connector and motor connector from the SERVOPACK.

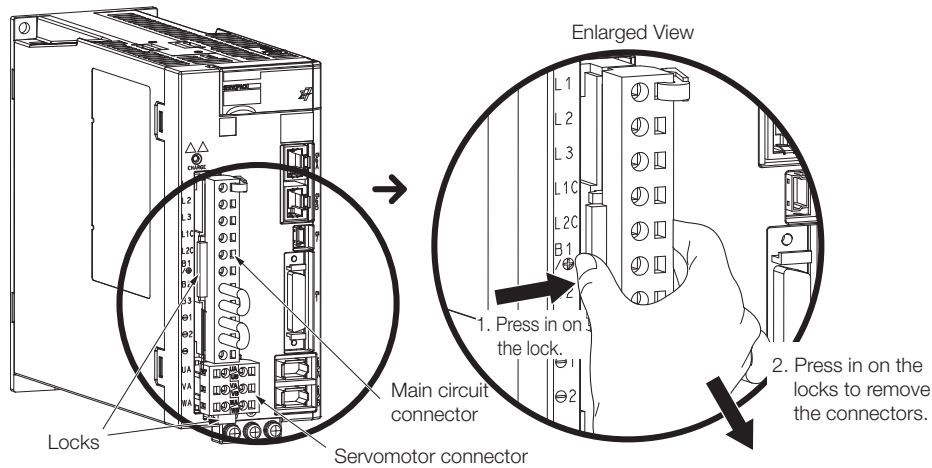

2. Remove the sheath from the wire to connect.

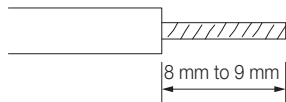

3. Open the wire insertion hole on the terminal connector with the tool. There are the following two ways to open the insertion hole. Use either method.

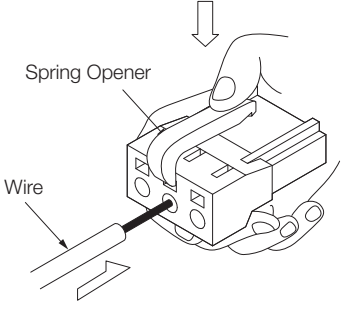
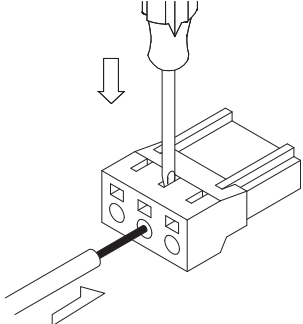
① Using a Spring Opener	② Using a Flat-blade Screwdriver
<p>Open the insertion hole with the Spring Opener as shown in the figure.</p>  <p>The diagram shows a hand using a Spring Opener to open the wire insertion hole on the terminal connector. A wire is shown inserted into the hole.</p>	<p>Firmly insert a flat-blade screwdriver into the screwdriver insertion hole to open the wire insertion hole.</p>  <p>The diagram shows a hand using a flat-blade screwdriver to open the wire insertion hole on the terminal connector. A wire is shown inserted into the hole.</p>

4. Insert the conductor into the wire insertion hole. Then, remove the Spring Opener or flat-blade screwdriver.
5. Make all other connections in the same way.
6. When you have completed wiring, attach the connectors to the SERVOPACK.

## 4.3.3 Power ON Sequence

Consider the following points when you design the power ON sequence.

- The ALM (Servo Alarm) signal is output for up to five seconds when the control power supply is turned ON. Take this into consideration when you design the power ON sequence, and turn ON the main circuit power supply to the SERVOPACK when the ALM signal is OFF (alarm cleared).

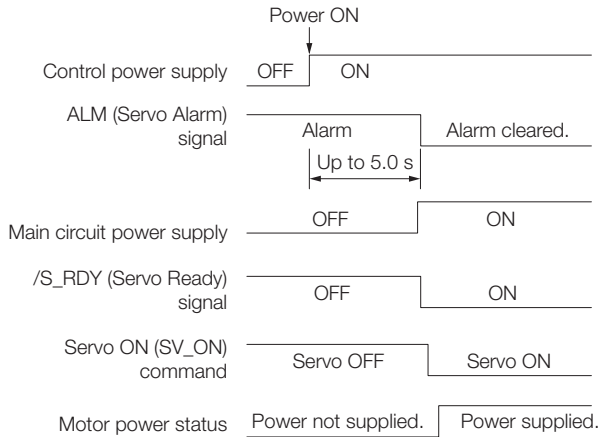

**Information** If the servo ON state cannot be achieved by inputting the SV\_ON command, the /S\_RDY signal is not ON. Check the status of the /S\_RDY signal. Refer to the following section for details.

 [6.1.6 /S-RDY \(Servo Ready\) Signal on page 6-12](#)

- Design the power ON sequence so that main circuit power supply is turned OFF when an ALM (Servo Alarm) signal is output.
- Make sure that the power supply specifications of all parts are suitable for the input power supply.
- Allow at least 1 s after the power supply is turned OFF before you turn it ON again.



Important

Turn ON the control power supply before the main circuit power supply or turn ON the control power supply and the main circuit power supply at the same time.  
Turn OFF the main circuit power supply first, and then turn OFF the control power supply.

 **WARNING**

- Even after you turn OFF the power supply, a high residual voltage may still remain in the SERVOPACK. To prevent electric shock, do not touch the power supply terminals after you turn OFF the power. When the voltage is discharged, the CHARGE indicator will turn OFF. Make sure the CHARGE indicator is OFF before you start wiring or inspection work.

## 4.3.4 Power Supply Wiring Diagrams

### Using Only One SERVOPACK

- Wiring Example for Three-Phase, 200-VAC Power Supply Input

The following diagram shows the wiring to stop both Servomotors when there is an alarm for one axis.

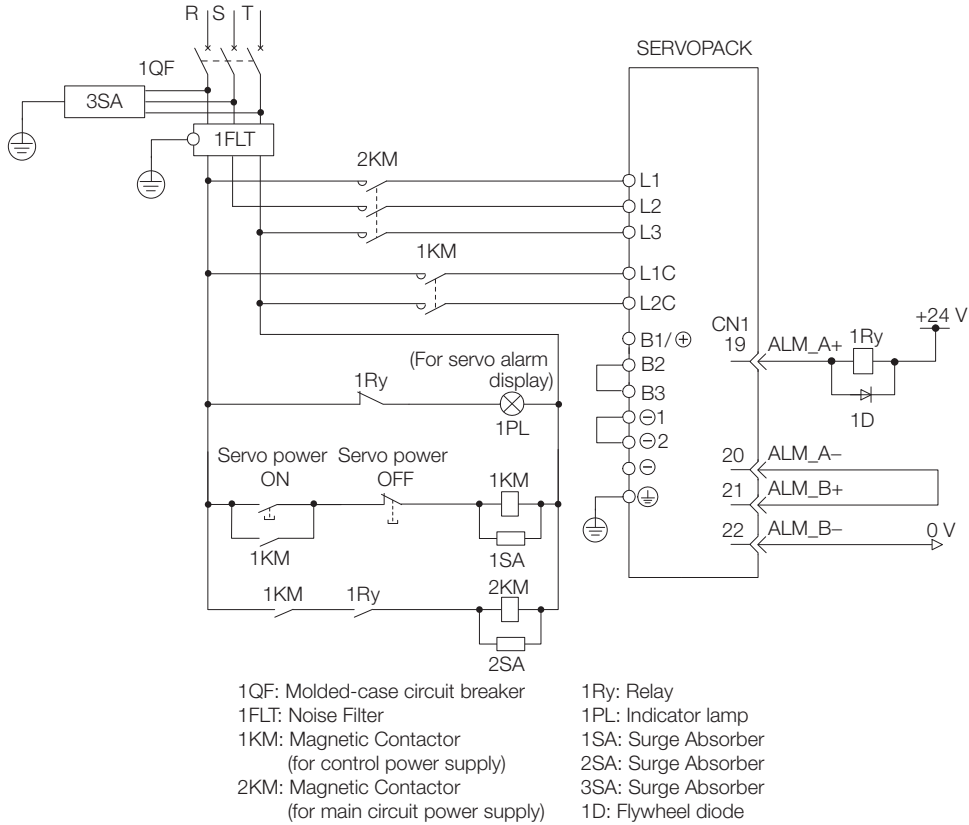

4.3 Wiring the Power Supply to the SERVOPACK

4.3.4 Power Supply Wiring Diagrams

• Wiring Example for Single-Phase, 200-VAC Power Supply Input

The following diagram shows the wiring to stop both Servomotors when there is an alarm for one axis.

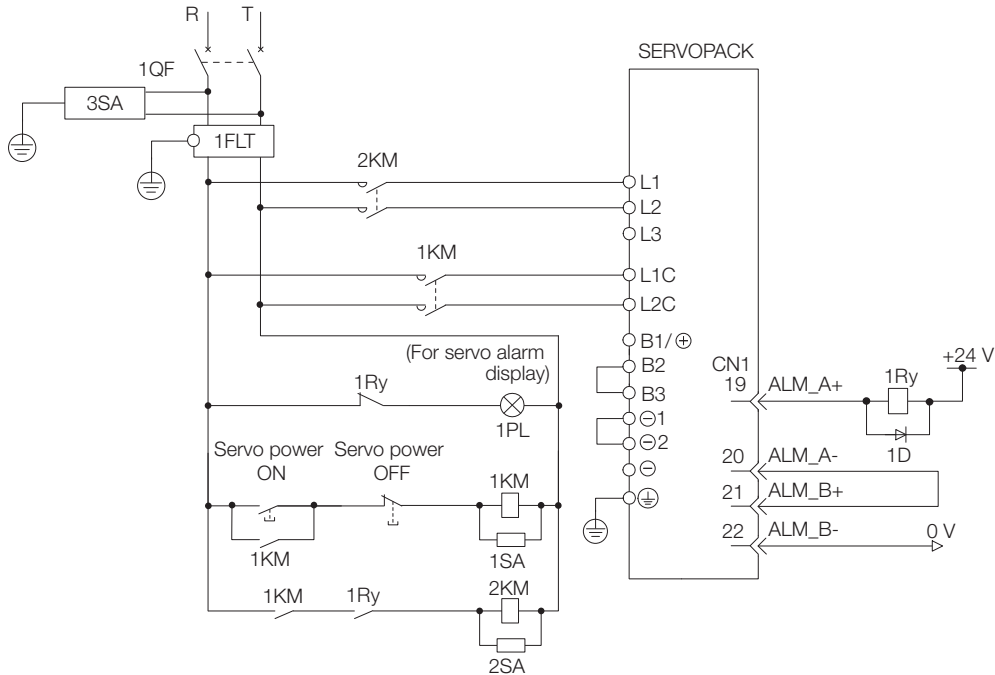

- 1QF: Molded-case circuit breaker
- 1FLT: Noise Filter
- 1KM: Magnetic Contactor (for control power supply)
- 2KM: Magnetic Contactor (for main circuit power supply)
- 1Ry: Relay
- 1PL: Indicator lamp
- 1SA: Surge Absorber
- 2SA: Surge Absorber
- 3SA: Surge Absorber
- 1D: Flywheel diode

• Wiring Example for DC Power Supply Input

The following diagram shows the wiring to stop both Servomotors when there is an alarm for one axis.

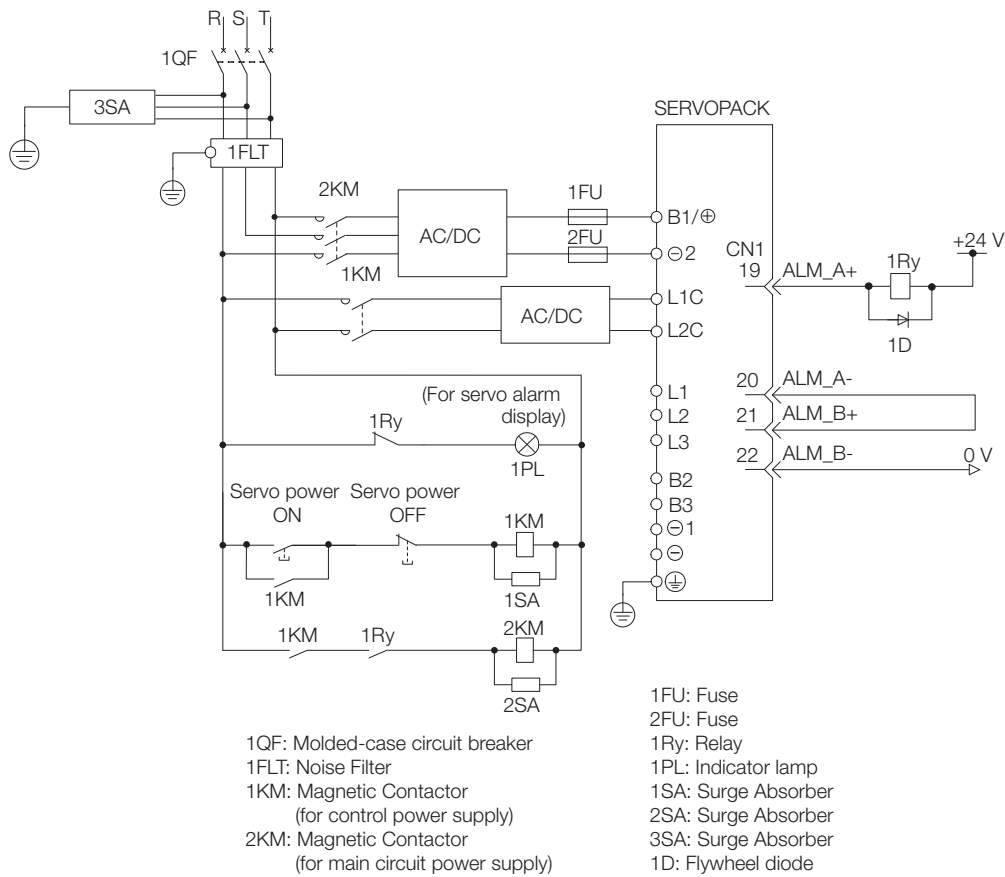

## Using More Than One SERVOPACK

Connect the ALM (Servo Alarm) output for these SERVOPACKs in series to operate the alarm detection relay (1RY).

When a SERVOPACK alarm is activated, the ALM output signal transistor turns OFF.

The following diagram shows the wiring to stop all of the Servomotors when there is an alarm for any one SERVOPACK.

More than one SERVOPACK can share a single Noise Filter. However, always select a Noise Filter that has a large enough capacity to handle the total power supply capacity of all the SERVOPACKs. Be sure to consider the load conditions.

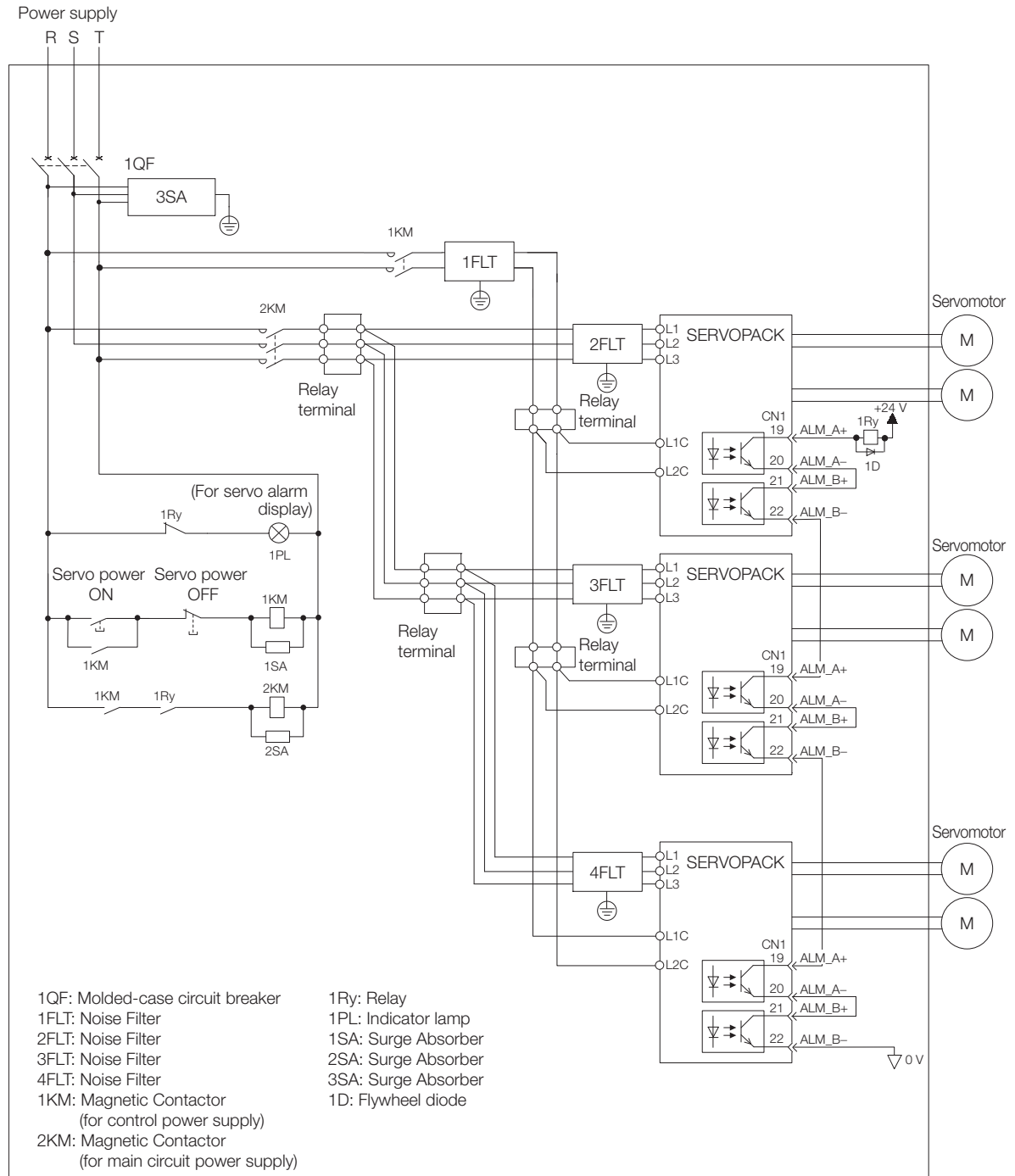



## 4.3.5 Wiring Regenerative Resistors

This section describes how to connect External Regenerative Resistors.

Refer to the following manual to select the capacity of a Regenerative Resistor.

📖  $\Sigma$ -7-Series Peripheral Device Selection Manual (Manual No.: SIEP S800001 32)



### WARNING

- Be sure to wire Regenerative Resistors correctly. Do not connect B1 $\oplus$  and B2. Doing so may result in fire or damage to the Regenerative Resistor or SERVOPACK.

### Connecting Regenerative Resistors

1. Remove the lead from between the B2 and B3 terminals on the SERVOPACK.

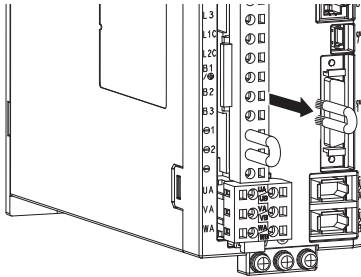

2. Connect the External Regenerative Resistor between the B1 $\oplus$  and B2 terminals.

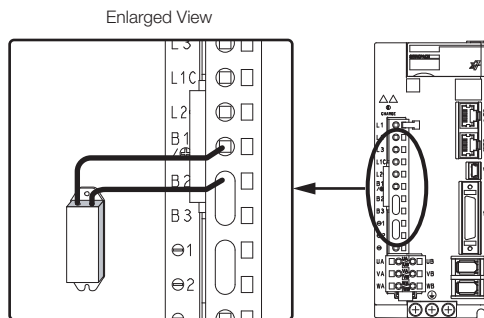

3. Set Pn600 (Regenerative Resistor Capacity) and Pn603 (Regenerative Resistor Resistance).

Refer to the following section for details on the settings.

📖 5.18 Setting the Regenerative Resistor Capacity on page 5-54

---

## 4.3.6 Wiring Reactors for Harmonic Suppression

---

You can connect a reactor for harmonic suppression to the SERVOPACK when power supply harmonic suppression is required. Refer to the following manual for details on reactors for harmonic suppression.

📖  $\Sigma$ -7-Series Peripheral Device Selection Manual (Manual No.: S1EP S800001 32)

Refer to the following figures to connect reactors.

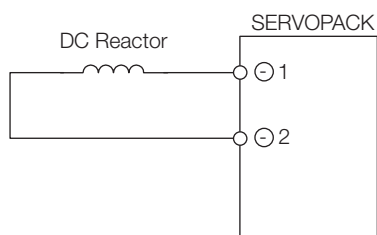



- Note: 1. Connection terminals ⊖ 1 and ⊖ 2 for a DC Reactor are connected when the SERVOPACK is shipped.  
Remove the lead wire and connect a DC Reactor.
2. Reactors are optional products. (Purchase them separately.)

## 4.4 Wiring Servomotors

### 4.4.1 Terminal Symbols and Terminal Names

The SERVOPACK terminals or connectors that are required to connect the SERVOPACK to a Servomotor are given below.

Terminal/Connector Symbols	Terminal/Connector Name	Remarks
UA, VA, and WA	Servomotor terminals for axis A	Refer to the following section for the wiring procedure.  <i>4.3.2 Wiring Procedure for Main Circuit Connector on page 4-12</i>
UB, VB, and WB	Servomotor terminals for axis B	
	Ground terminal	–
CN2A	Encoder connector for axis A	–
CN2B	Encoder connector for axis B	–

### 4.4.2 Pin Arrangement of Encoder Connectors (CN2A and CN2B)

- When Using a Rotary Servomotor

Pin No.	Signal	Function
1	PG5V	Encoder power supply +5 V
2	PG0V	Encoder power supply 0 V
3	BAT (+)*	Battery for absolute encoder (+)
4	BAT (-)*	Battery for absolute encoder (-)
5	PS	Serial data (+)
6	/PS	Serial data (-)
Shell	Shield	–

\* No wiring is required for an incremental encoder or a batteryless absolute encoder.

- When Using a Direct Drive Servomotor

Pin No.	Signal	Function
1	PG5V	Encoder power supply +5 V
2	PG0V	Encoder power supply 0 V
3	–	– (Do not use.)
4	–	– (Do not use.)
5	PS	Serial data (+)
6	/PS	Serial data (-)
Shell	Shield	–

- When Using a Linear Servomotor

Pin No.	Signal	Function
1	PG5V	Linear encoder power supply +5 V
2	PG0V	Linear encoder power supply 0 V
3	–	– (Do not use.)
4	–	– (Do not use.)
5	PS	Serial data (+)
6	/PS	Serial data (-)
Shell	Shield	–

## 4.4.3 Wiring the SERVOPACK to the Encoder

### When Using an Absolute Encoder

If you use an absolute encoder, use an Encoder Cable with a JUSP-BA01-E Battery Case or install a battery on the host controller.

Refer to the following section for the battery replacement procedure.

 10.1.3 Replacing the Battery on page 10-3

- Wiring Example When Using an Encoder Cable with a Battery Case

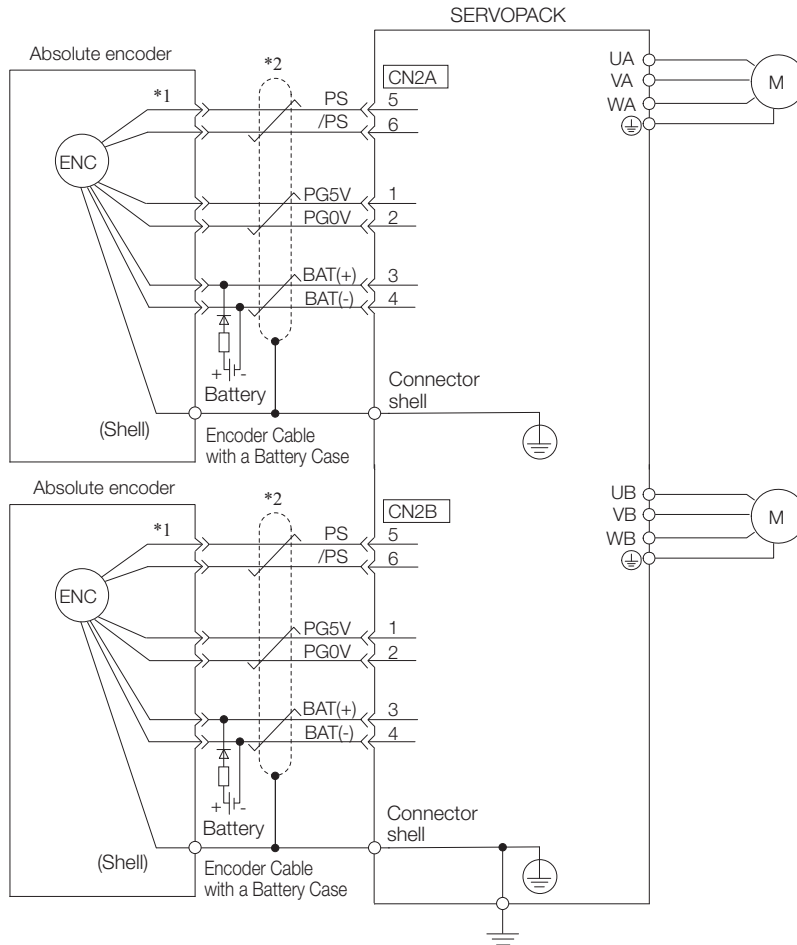

\*1. The absolute encoder pin numbers for wiring the connector depend on the Servomotor that you use.

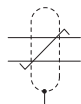
\*2.  represents a shielded twisted-pair cable.

• Wiring Example When Installing a Battery on the Host Controller

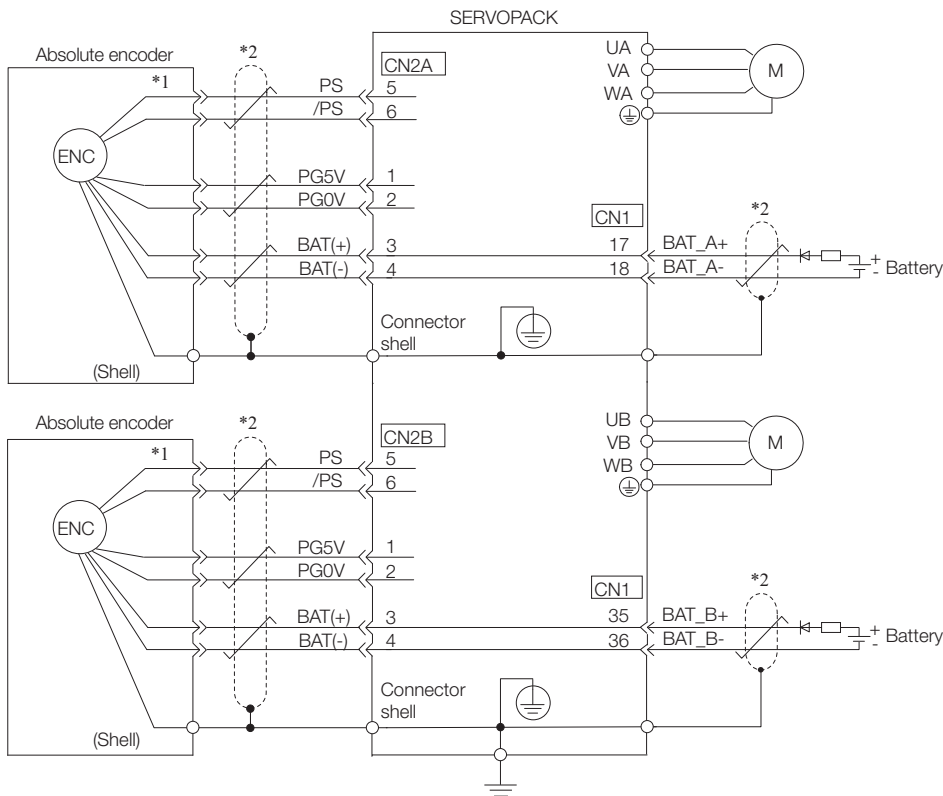

\*1. The absolute encoder pin numbers for wiring the connector depend on the Servomotor that you use.

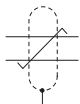
\*2.  represents a shielded twisted-pair cable.



Important

- When Installing a Battery on the Encoder Cable  
Use the Encoder Cable with a Battery Case that is specified by Yaskawa. Refer to the following manual for details.  
  $\Sigma$ -7-Series Peripheral Device Selection Manual (Manual No.: S1EP S800001 32)
- When Installing a Battery on the Host Controller  
Insert a diode near the battery to prevent reverse current flow.

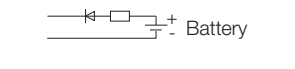
<b>Circuit Example</b>	Required Component Specifications
	<ul style="list-style-type: none"> <li>• Schottky Diode Reverse Voltage: <math>V_r \geq 40\text{ V}</math> Forward Voltage: <math>V_f \leq 0.37\text{ V}</math> Reverse current: <math>I_r \leq 5\ \mu\text{A}</math> Junction temperature: <math>T_j \geq 125^\circ\text{C}</math></li> <li>• Resistor Resistance: <math>22\ \Omega</math> Tolerance: <math>\pm 5\%</math> max. Rated power: <math>0.25\text{ W min.}</math></li> </ul>

## When Using an Incremental Encoder or Batteryless Absolute Encoder

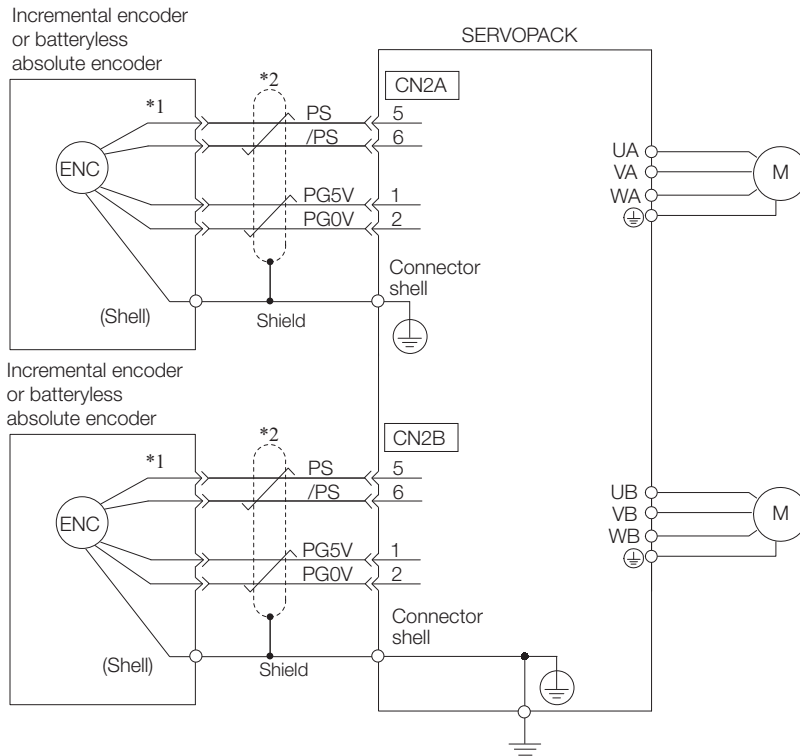

\*1. The encoder pin numbers for wiring the connector depend on the Servomotor that you use.

\*2.  represents a shielded twisted-pair cable.

## When Using an Absolute Linear Encoder

The wiring depends on the manufacturer of the linear encoder.

### ◆ Connections to Absolute Linear Encoder from Mitutoyo Corporation

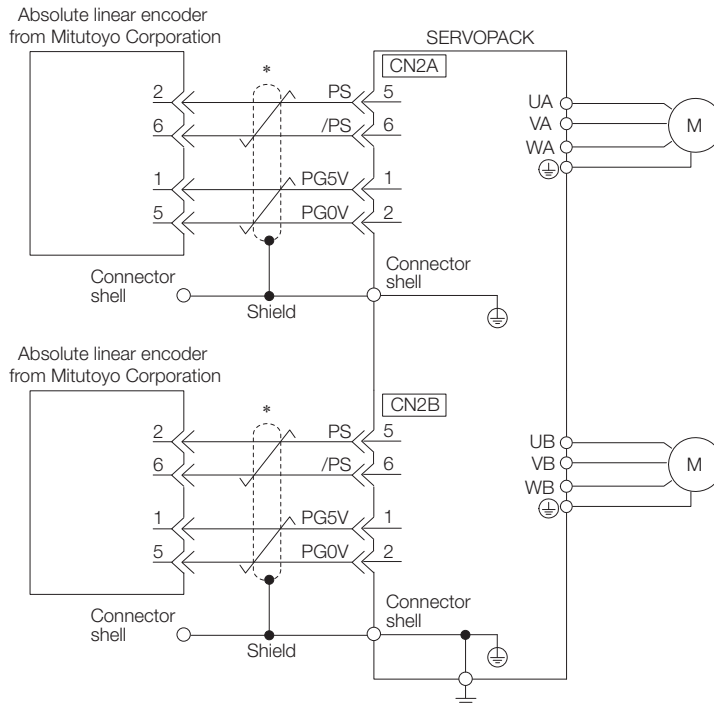

\*  represents a shielded twisted-pair cable.

### ◆ Connections to Absolute Linear Encoder from Renishaw PLC

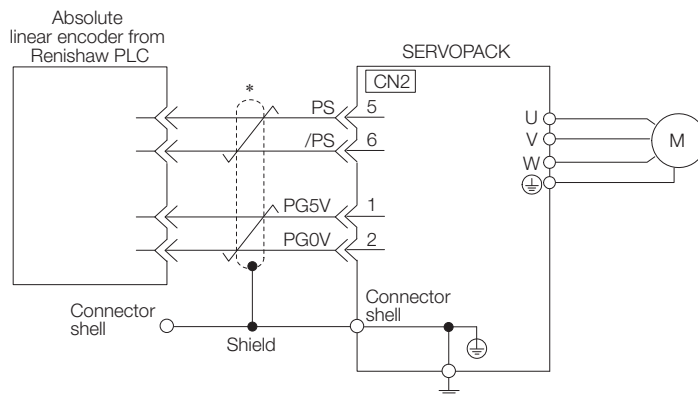

\*  represents a shielded twisted-pair cable.

◆ Connections to Absolute Linear Encoder from Magescale Co., Ltd.

■ SR77, SR87, SQ47, and SQ57

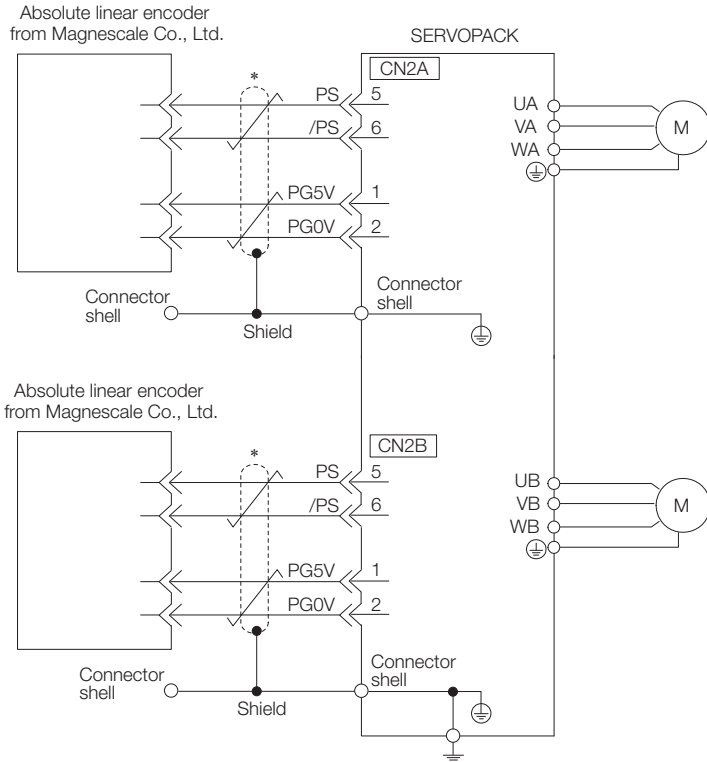

\*  represents a shielded twisted-pair cable.



## When Using an Incremental Linear Encoder

The wiring depends on the manufacturer of the linear encoder.

### ◆ Connections to Linear Encoder from Heidenhain Corporation

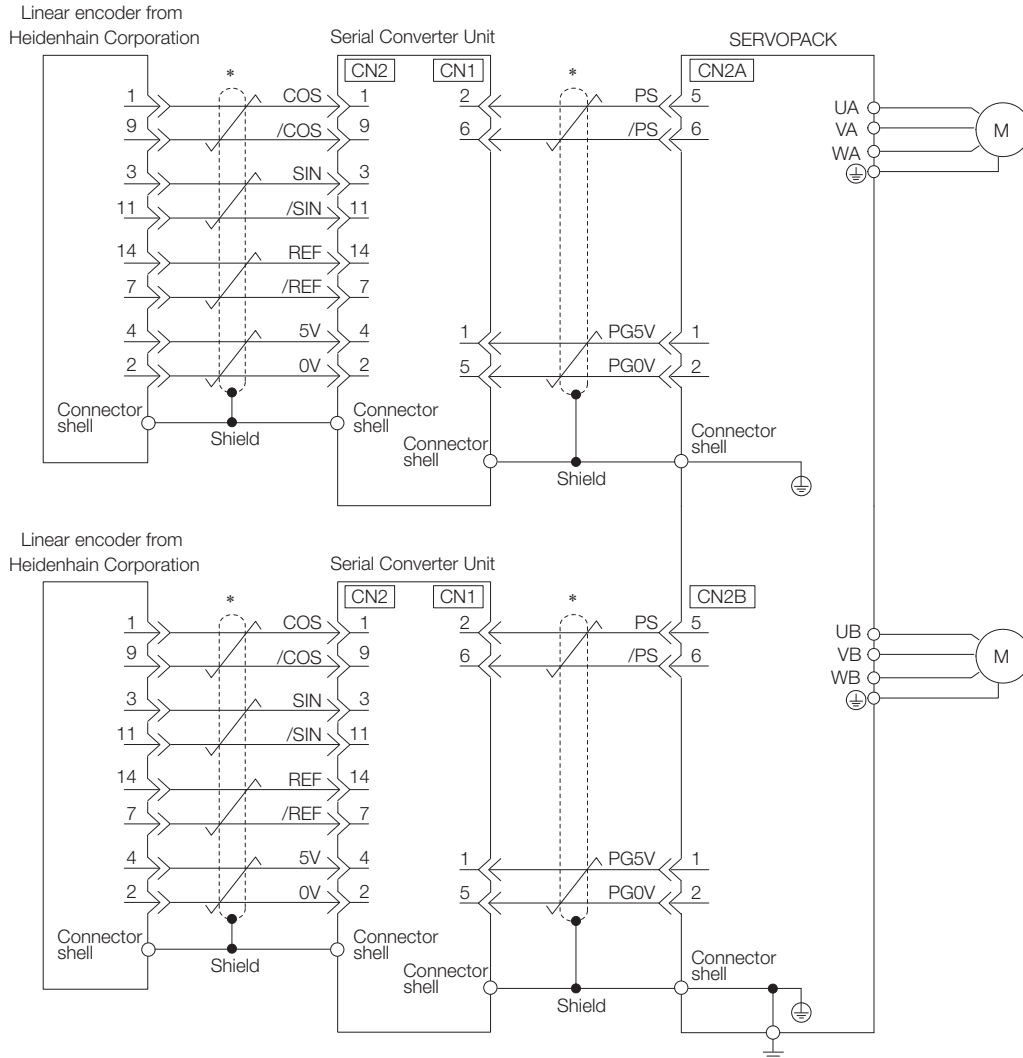

\*  represents a shielded twisted-pair cable.

◆ Connections to Linear Encoder from Renishaw PLC

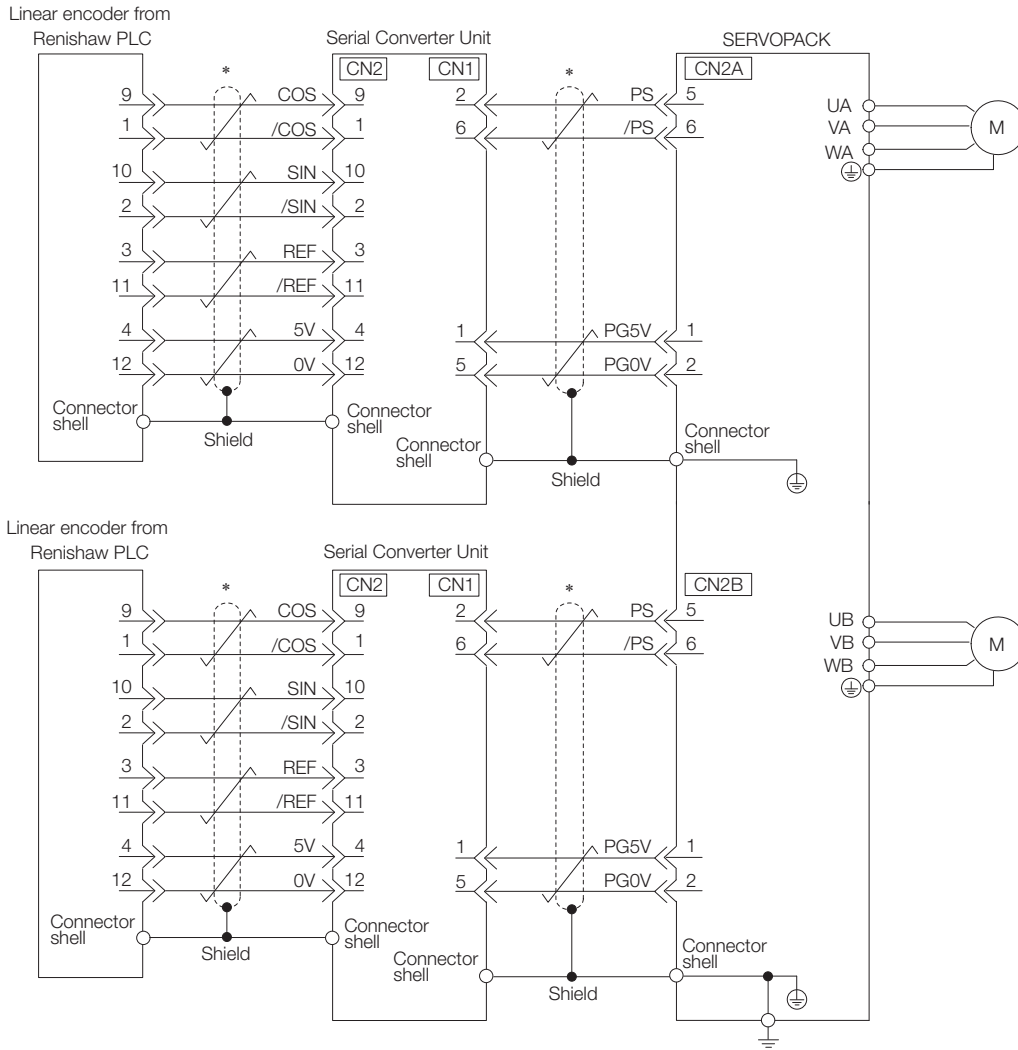

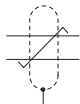

\*  represents a shielded twisted-pair cable.

◆ **Connections to Linear Encoder from Magnescale Co., Ltd.**

If you use a linear encoder from Magnescale Co., Ltd., the wiring will depend on the model of the linear encoder.

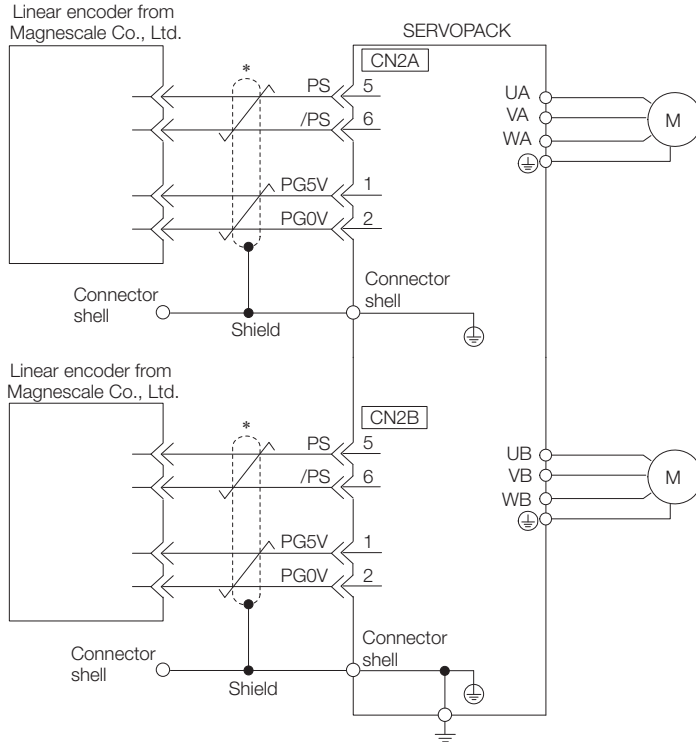
■ **SR75 and SR85**



\*  represents a shielded twisted-pair cable.

■ SL700, SL710, SL720, SL730, and SQ10

- PL101-RY, MQ10-FLA, or MQ10-GLA Interpolator

The following table gives the Linear Encoder and Interpolator combinations.

Linear Encoder Model	Interpolator Model
SL700, SL710, SL720, and SL730	PL101-RY*1
SQ10	MQ10-FLA*2
	MQ10-GLA*2

\*1. This is the model of the Head with Interpolator.

\*2. This is the model of the Interpolator.

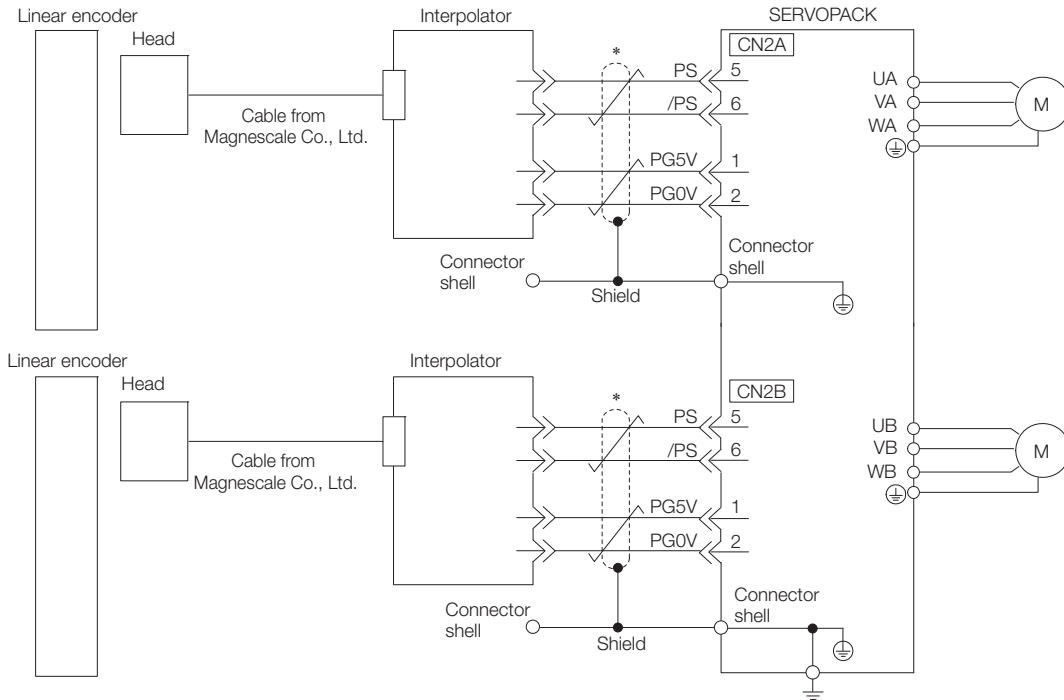

\*  represents a shielded twisted-pair cable.

- SL700, SL710, SL720, and SL730
- MJ620-T13 Interpolator

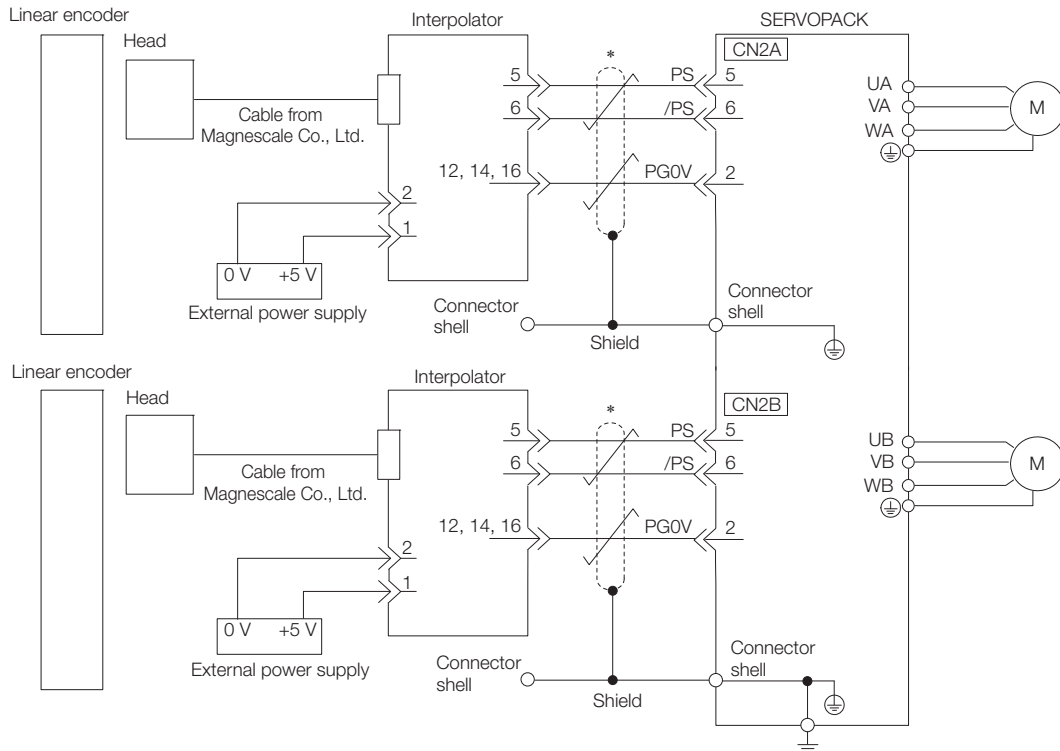

\*  represents a shielded twisted-pair cable.

## 4.4.4 Wiring the SERVOPACK to the Holding Brake



- If you use a Rotary Servomotor, select a Surge Absorber according to the brake current and brake power supply. Refer to the following manual for details.  
  $\Sigma$ -7-Series Peripheral Device Selection Manual (Manual No.: SIEP S800001 32)
- After the Surge Absorber is connected, check the brake operation delay time in your application. The Surge Absorber may affect the brake operation delay time. Configure the relay circuit to activate the holding brake for an emergency stop.

### Relay Circuit Example

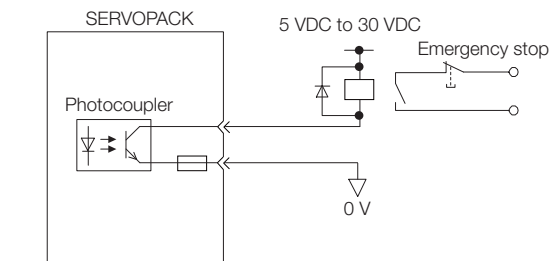

- You can change the output signal allocation of the /BK signal. Refer to the following section for details.  
 **Allocating the /BK (Brake) Signal** on page 5-34
- If you use a 24-V brake, install a separate power supply for the 24-VDC power supply from other power supplies, such as the one for the I/O signals of the CN1 connector. If the power supply is shared, the I/O signals may malfunction.

4.4 Wiring Servomotors

4.4.4 Wiring the SERVOPACK to the Holding Brake

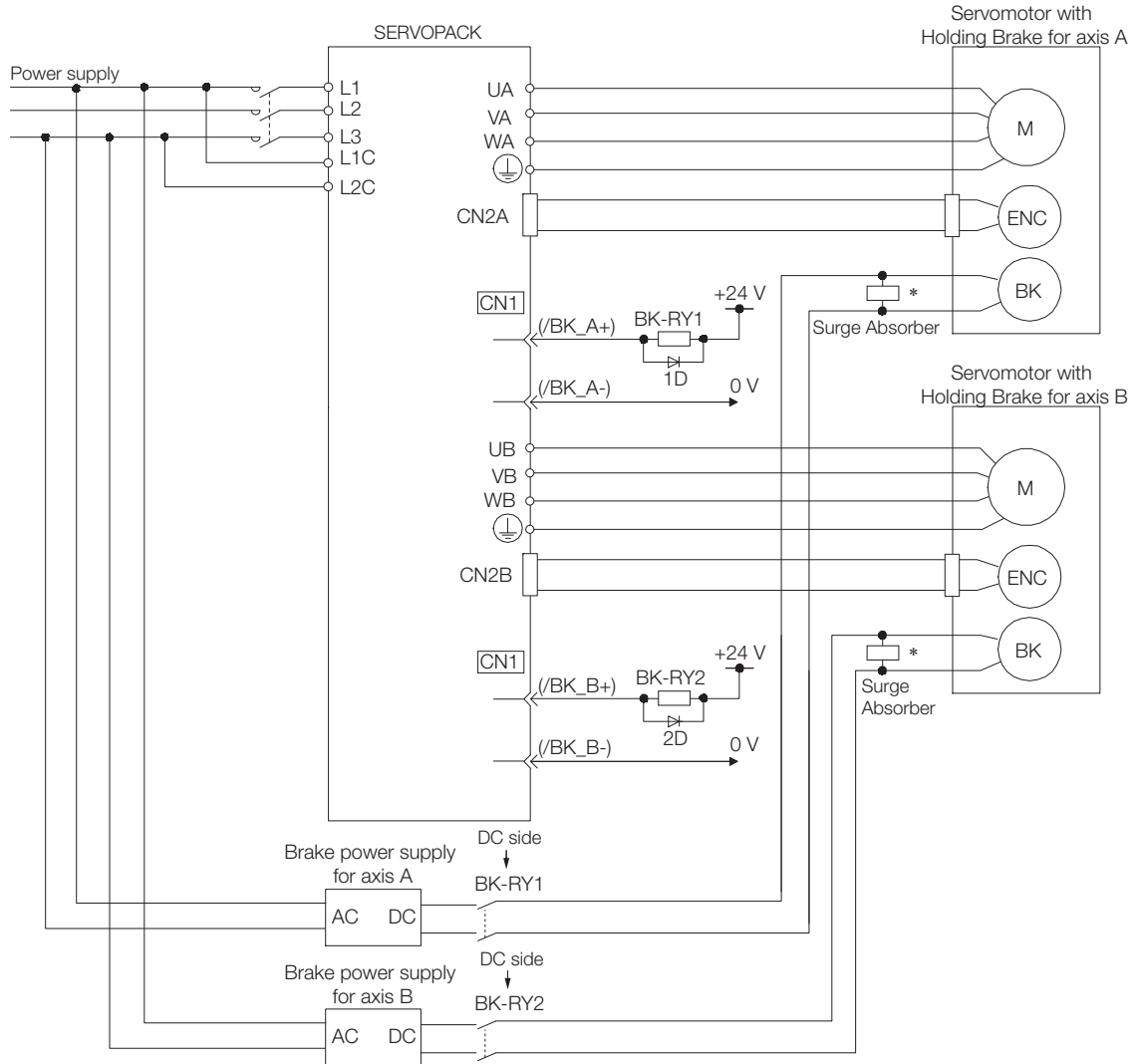

BK-RY1 and BK-RY2: Brake control relays  
 1D and 2D: Flywheel diodes

\* Install the surge absorber near the brake terminals on the Servomotor.

## 4.5 I/O Signal Connections

### 4.5.1 I/O Signal Connector (CN1) Names and Functions

The following table gives the pin numbers, names, and functions the I/O signal pins for the default settings.

#### Input Signals

Default settings are given in parentheses.

Signal	Pin No.	Name	Function	Reference	
/SI01* (P-OT_A)	3	General-purpose Sequence Inputs 1 and 7 (Forward Drive Prohibit Input)	You can allocate the input signals to use with parameters. (Stops Servomotor drive (to prevent overtravel) when the moving part of the machine exceeds the range of movement.)	page 5-28	
/SI07* (P-OT_B)	9				
/SI02* (N-OT_A)	4	General-purpose Sequence Inputs 2 and 8 (Reverse Drive Prohibit Input)	<ul style="list-style-type: none"> <li>• For A axis: /SI01 and /SI02</li> <li>• For B axis: /SI07 and /SI08</li> </ul>		
/SI08* (N-OT_B)	10				
/SI03* (/DEC_A)	5	General-purpose Sequence Inputs 3 and 9 (Origin Return Decelera- tion Switch Input)	You can allocate the input signals to use with parameters. (Connects the deceleration limit switch for origin return.)	-	
/SI09* (/DEC_B)	11				
/SI04* (/EXT_A1)	6	General-purpose Sequence Inputs 4 and 10 (External Latch Input 1)	You can allocate the input signals to use with parameters. (Connect the external signals that latch the current feedback pulse counter.)	-	
/SI10* (/EXT_B1)	12				
/SI05* (/EXT_A2)	7	General-purpose Sequence Inputs 5 and 11 (External Latch Input 2)	<ul style="list-style-type: none"> <li>• For A axis: /SI04, /SI05, and / SI06</li> <li>• For B axis: /SI10, /SI11, and / SI12</li> </ul>		
/SI11* (/EXT_B2)	13				
/SI06* (/EXT_A3)	8	General-purpose Sequence Inputs 6 and 12 (External Latch Input 3)			
/SI12* (/EXT_B3)	14				
+24VIN	1	Sequence Input Signal Power Supply Input	Inputs the sequence input signal power supply. Allowable voltage range: 24 VDC ±20% The 24-VDC power supply is not provided by Yaskawa.	-	
BAT_A+	17	Battery for Absolute Encoder (+)	Connecting pin for the absolute encoder backup battery. Do not connect these pins if you use the Encoder Cable with a Bat- tery Case.	page 6-48	
BAT_B+	35				
BAT_A-	18	Battery for Absolute Encoder (-)			<ul style="list-style-type: none"> <li>• For A axis: BAT_A+ and BAT_A-</li> <li>• For B axis: BAT_B+ and BAT_B-</li> </ul>
BAT_B-	36				
TH_A	33	Overheat protection inputs	Inputs the overheat protection sig- nal from a Linear Servomotor or from a sensor attached to the machine.	page 6-48	
TH_B	34				<ul style="list-style-type: none"> <li>• For A axis: TH_A</li> <li>• For B axis: TH_B</li> </ul>

\* You can change the allocations. Refer to the following section for details.

 6.1.1 Input Signal Allocations on page 6-3

## 4.5.1 I/O Signal Connector (CN1) Names and Functions

Note: If forward drive prohibition or reverse drive prohibition is used, the SERVOPACK is stopped by software controls. If the application does not satisfy the safety requirements, add external safety circuits as required.

## Output Signals

Default settings are given in parentheses.

Signal	Pin No.	Name	Function	Reference
ALM_A+	19	Servo Alarm Output	Turns OFF (opens) when an error is detected. • For A axis: ALM_A+ and ALM_A- • For B axis: ALM_B+ and ALM_B-	page 6-10
ALM_A-	20			
ALM_B+	21			
ALM_B-	22			
/SO1+* (/BK_A+)	23	General-purpose Sequence Output 1 (Brake Output)	You can allocate the output signal to use with a parameter. (Controls the brake. The brake is released when the signal turns ON (closes).) • For A axis: /BK_A+ and /BK_A- • For B axis: /BK_B+ and /BK_B-	page 5-33
/SO1-* (/BK_A-)	24			
/SO2+* (/BK_B+)	25	General-purpose Sequence Output 2 (Brake Output)		
/SO2-* (/BK_B-)	26			
/SO3+*	27	General-purpose Sequence Output 3		
/SO3-*	28			
/SO4+*	29	General-purpose Sequence Output 4	Used for general-purpose outputs. Set the parameters to allocate functions.	-
/SO4-*	30			
/SO5+*	31	General-purpose Sequence Output 5		
/SO5-*	32			
SG	16 15	Signal ground	This is the 0-V signal for the control circuits.	-
FG	Shell	Frame ground	Connected to the frame ground if the shield of the I/O Signal Cable is connected to the connector shell.	-

\* You can change the allocations. Refer to the following section for details.

 6.1.2 Output Signal Allocations on page 6-6



## 4.5.2 I/O Signal Connector (CN1) Pin Arrangement

The following figure gives the pin arrangement of the of the I/O signal connector (CN1) for the default settings.

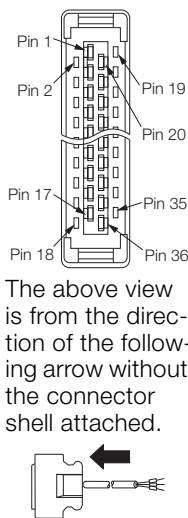

2	-	-	1	+24VIN	Sequence Input Signal Power Supply Input	20	ALM_A-	Servo Alarm Output for Axis A	19	ALM_A+	Servo Alarm Output for Axis A
4	/SI02 (N-OT_A)	General-purpose Sequence Input 2	3	/SI01 (P-OT_A)	General-purpose Sequence Input 1	22	ALM_B-	Servo Alarm Output for Axis B	21	ALM_B+	Servo Alarm Output for Axis B
6	/SI04 (/EXT_A1)	General-purpose Sequence Input 4	5	/SI03 (/DEC_A)	General-purpose Sequence Input 3	24	/SO1- (/BK_A-)	General-purpose Sequence Output 1	23	/SO1+ (/BK_A+)	General-purpose Sequence Output 1
8	/SI06 (/EXT_A3)	General-purpose Sequence Input 6	7	/SI05 (/EXT_A2)	General-purpose Sequence Input 5	26	/SO2- (/BK_B-)	General-purpose Sequence Output 2	25	/SO2+ (/BK_B+)	General-purpose Sequence Output 2
10	/SI08 (N-OT_B)	General-purpose Sequence Input 8	9	/SI07 (P-OT_B)	General-purpose Sequence Input 7	28	/SO3-	General-purpose Sequence Output 3	27	/SO3+	General-purpose Sequence Output 3
12	/SI10 (/EXT_B1)	General-purpose Sequence Input 10	11	/SI09 (/DEC_B)	General-purpose Sequence Input 9	30	/SO4-	General-purpose Sequence Output 4	29	/SO4+	General-purpose Sequence Output 4
14	/SI12 (/EXT_B3)	General-purpose Sequence Input 12	13	/SI11 (/EXT_B2)	General-purpose Sequence Input 11	32	/SO5-	General-purpose Sequence Output 5	31	/SO5+	General-purpose Sequence Output 5
16	SG	Signal Ground	15	SG	Signal Ground	34	TH_B	Overheat Protection Input (Axis B)	33	TH_A	Overheat Protection Input (Axis A)
18	BAT_A-	Battery for Absolute Encoder (-) for Axis A	17	BAT_A+	Battery for Absolute Encoder (+) for Axis A	36	BAT_B-	Battery for Absolute Encoder (-) for Axis B	35	BAT_B+	Battery for Absolute Encoder (+) for Axis B

## 4.5.3 I/O Signal Wiring Examples

### Using a Rotary Servomotor

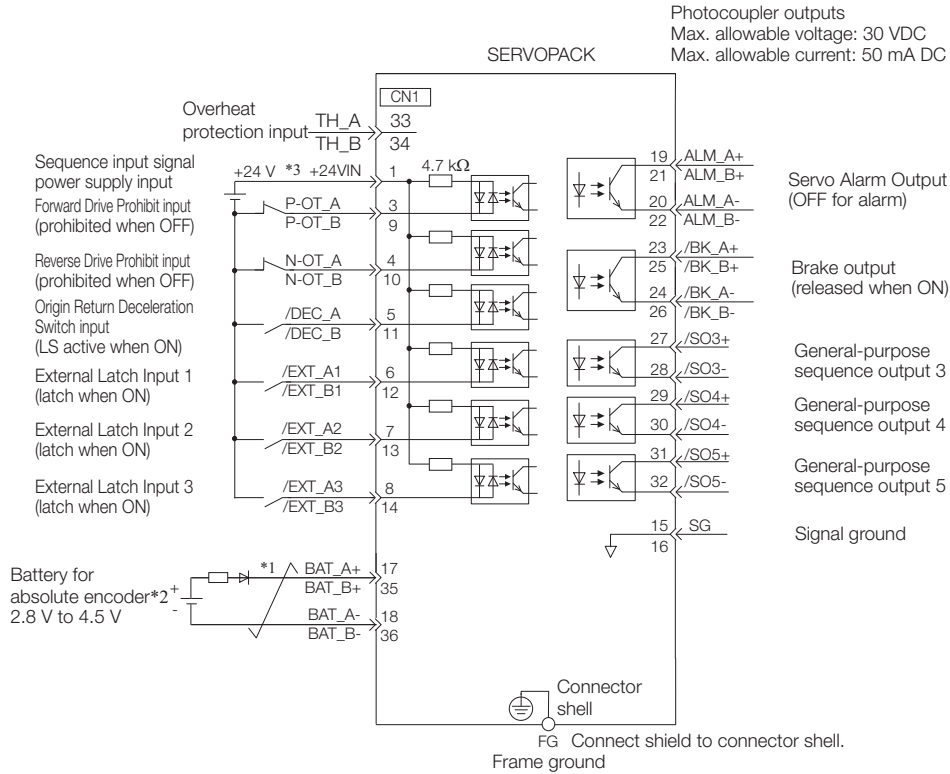

\*1. represents twisted-pair wires.

\*2. Connect these when using an absolute encoder. If the Encoder Cable with a Battery Case is connected, do not connect a backup battery.

\*3. The 24-VDC power supply is not provided by Yaskawa. Use a 24-VDC power supply with double insulation or reinforced insulation.

Note: 1. You can use parameter settings to change some of the I/O signal allocations. Refer to the following section for details.

**6.1 I/O Signal Allocations on page 6-3**

2. If you use a 24-V brake, install a separate power supply for the 24-VDC power supply from other power supplies, such as the one for the I/O signals of the CN1 connector.  
If the power supply is shared, the I/O signals may malfunction.

# Using a Linear Servomotor

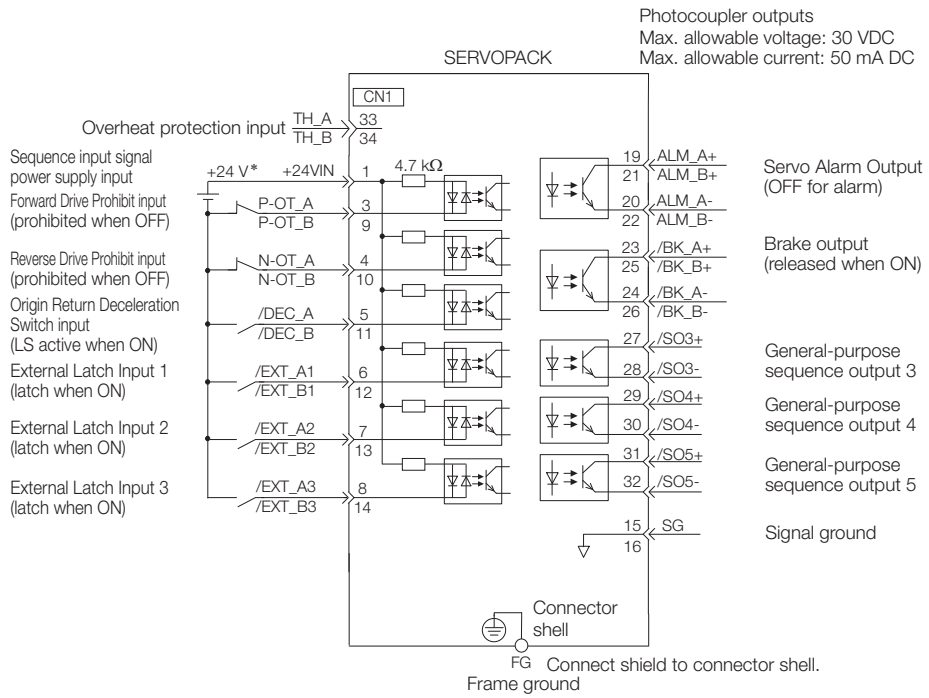

\* The 24-VDC power supply is not provided by Yaskawa. Use a 24-VDC power supply with double insulation or reinforced insulation.

Note: 1. You can use parameter settings to change some of the I/O signal allocations. Refer to the following section for details.

**6.1 I/O Signal Allocations on page 6-3**

2. If you use a 24-V brake, install a separate power supply for the 24-VDC power supply from other power supplies, such as the one for the I/O signals of the CN1 connector. If the power supply is shared, the I/O signals may malfunction.

## 4.5.4 I/O Circuits

### Sequence Input Circuits

#### ◆ Photocoupler Input Circuits

This section describes CN1 connector terminals 1 and 3 to 14.

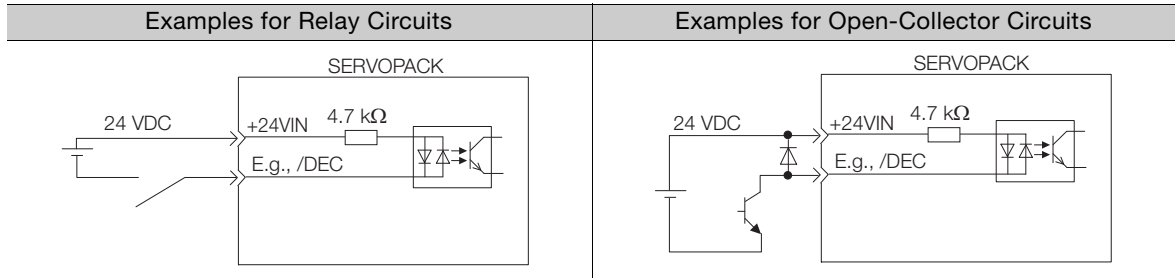

Note: The 24-VDC external power supply capacity must be 100 mA minimum.

The SERVOPACK input circuits use bidirectional photocouplers. Select either a sink circuit or source circuit according to the specifications required by the machine.

Note: The connection examples in 4.5.3 I/O Signal Wiring Examples on page 4-36 are for sink circuit connections.

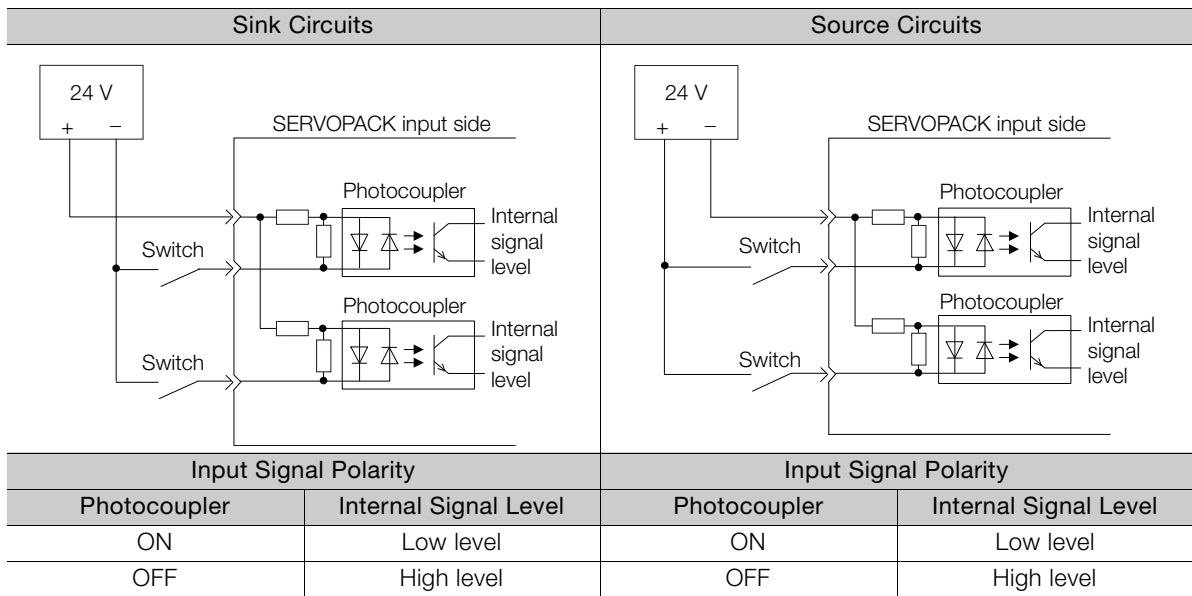

## Sequence Output Circuits



Important

Incorrect wiring or incorrect voltage application to the output circuits may cause short-circuit failures.

If a short-circuit failure occurs as a result of any of these causes, the holding brake will not work. This could damage the machine or cause an accident that may result in death or injury.

### ◆ Photocoupler Output Circuits

Photocoupler output circuits are used for the ALM (Servo Alarm), /S-RDY (Servo Ready), and other sequence output signals. Connect a photocoupler output circuit to a relay or line-receiver circuit.

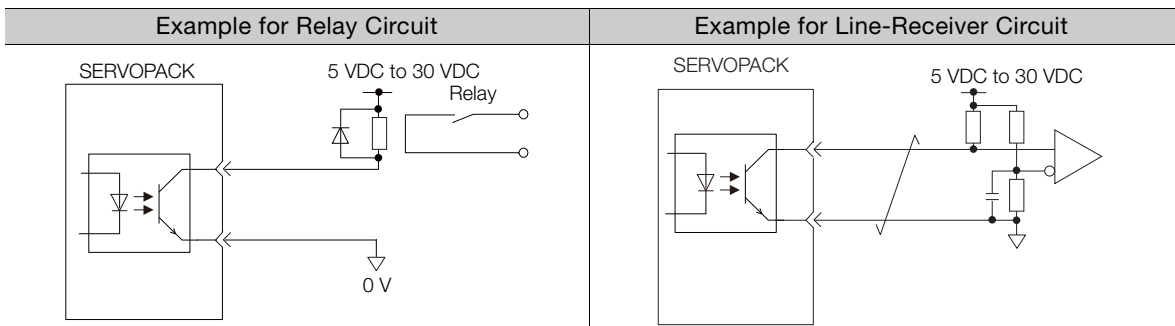

Note: The maximum allowable voltage and current range for photocoupler output circuits are as follows:

- Maximum allowable voltage: 30 VDC
- Current range: 5 mA to 50 mA DC

# 4.6 Connecting MECHATROLINK-III Communications Cables (RJ-45)

Connect the MECHATROLINK-III Communications Cables (RJ-45) to the CN6A and CN6B connectors.

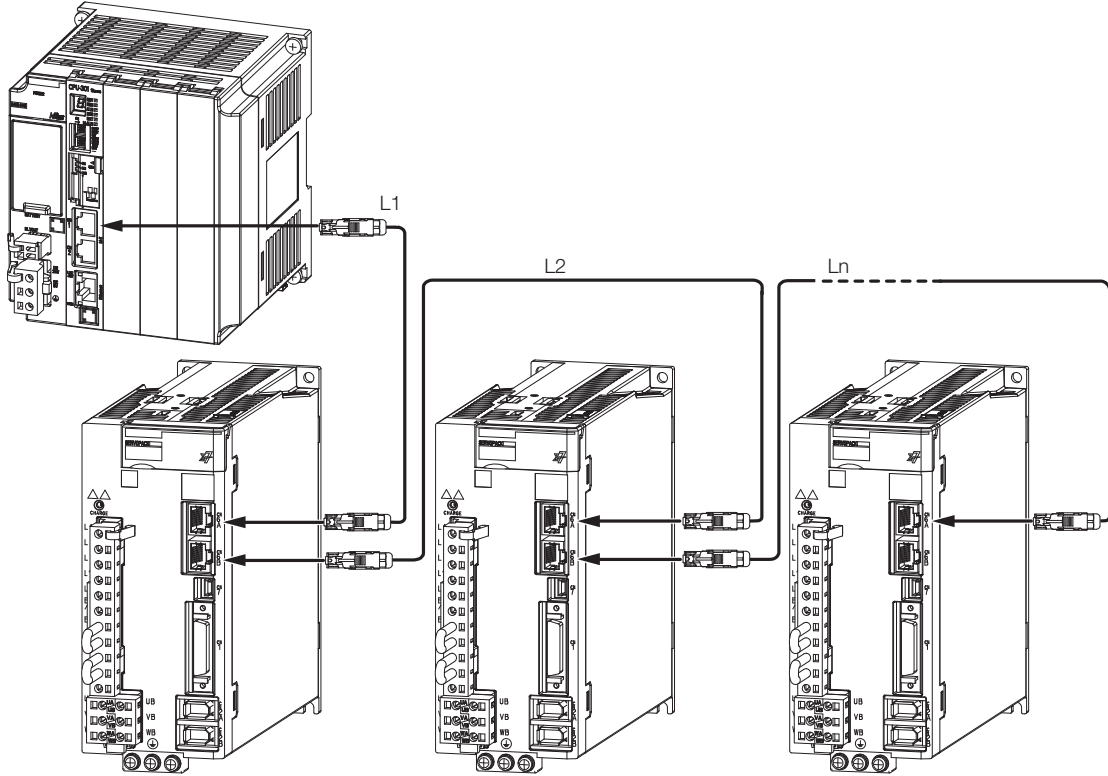

Note: The length of the cable between stations (L1, L2, ... Ln) must be 50 m or less.

Use the cables specified in the selection table for the MECHATROLINK-III Communications Cables (RJ-45). The maximum cable lengths are as follows:

- Cables with Connectors on Both Ends and No Ferrite Cores: 30 m
- Cables with Connectors on Both Ends and Ferrite Cores: 50 m

## Selection Table

Type	Length (L)	Order Number*	Inquiries
Cables with Connectors on Both Ends and No Ferrite Cores	0.2 m, 0.5 m, 1 m, 2 m, 3 m, 4 m, 5 m, 10 m, 20 m, and 30 m	JZSP-CM3RR00-□□-E (□□: 00P2/00P5/01/02/03/04/05/10/20/30)	Yaskawa Controls Co., Ltd.
Cables with Connectors on Both Ends and Ferrite Cores	10 m, 20 m, 30 m, and 50 m	JZSP-CM3RR01-□□-E (□□: 10/20/30/50)	

\* Replace the boxes (□□) in the order number with the code for the cable length.

## External Dimensions

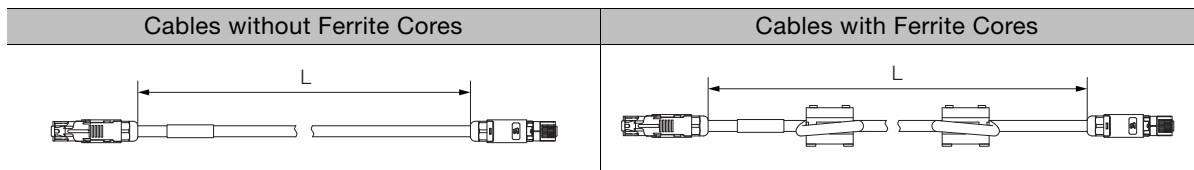

## 4.7 Connecting the Other Connectors

### 4.7.1 Serial Communications Connector (CN502)

To use an RS-422 cable to connect a Digital Operator, connect it to CN502 on the SERVOPACK. A JUSP-JC001-1 Communications Unit is required to make the connection.

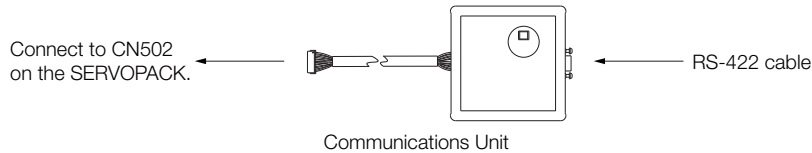

### Communications Unit

Item	Description
Inquiries	Your Yaskawa representative
Order Number	JUSP-JC001-1
External Dimensions	<p>Approx. mass: 0.08 kg Unit: mm</p>

Refer to the following manual for the operating procedures for the Digital Operator.

📖  $\Sigma$ -7-Series Digital Operator Operating Manual (Manual No.: SIEP S800001 33)

### 4.7.2 Computer Connector (CN7)

To use the SigmaWin+ Engineering Tool, connect the computer on which the SigmaWin+ is installed to CN7 on the SERVOPACK.

Refer to the following manual for the operating procedures for the SigmaWin+.

📖 AC Servo Drive Engineering Tool SigmaWin+ Operation Manual (Manual No.: SIET S800001 34)



Important

Use the Yaskawa-specified cables. Operation will not be dependable due to low noise resistance with any other cable.

## 4.7.3 Analog Monitor Connector (CN5)

To use an analog monitor, connect CN5 on the SERVOPACK.

- Wiring Example

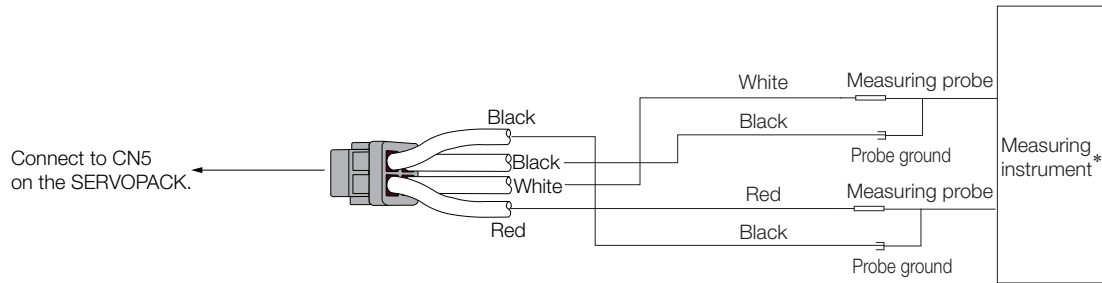

\* The measuring instrument is not provided by Yaskawa.

Refer to the following section for information on the monitoring methods for an analog monitor.

 9.3 Monitoring Machine Operation Status and Signal Waveforms on page 9-6



# Basic Functions That Require Setting before Operation

# 5

This chapter describes the basic functions that must be set before you start servo system operation. It also describes the setting methods.

<b>5.1</b>	<b>Manipulating Parameters (Pn□□□) . . . . .</b>	<b>5-3</b>
5.1.1	Parameter Classification . . . . .	5-3
5.1.2	Notation for Parameters . . . . .	5-4
5.1.3	Parameter Setting Methods . . . . .	5-5
5.1.4	Write Prohibition Setting for Parameters . . . . .	5-6
5.1.5	Initializing Parameter Settings . . . . .	5-9
<b>5.2</b>	<b>MECHATROLINK-III Communications Settings . .</b>	<b>5-11</b>
5.2.1	Communications Settings . . . . .	5-11
5.2.2	Setting the Station Address . . . . .	5-11
5.2.3	Extended Address Setting . . . . .	5-12
<b>5.3</b>	<b>Power Supply Type Settings for the Main Circuit and Control Circuit . .</b>	<b>5-13</b>
5.3.1	AC Power Supply Input/DC Power Supply Input Setting . . . . .	5-13
5.3.2	Single-phase AC Power Supply Input/Three-phase AC Power Supply Input Setting . . . . .	5-14
<b>5.4</b>	<b>Automatic Detection of Connected Motor . . . . .</b>	<b>5-15</b>
<b>5.5</b>	<b>Motor Direction Setting . . . . .</b>	<b>5-16</b>
<b>5.6</b>	<b>Setting the Linear Encoder Pitch . . . . .</b>	<b>5-17</b>
<b>5.7</b>	<b>Writing Linear Servomotor Parameters . . .</b>	<b>5-18</b>
<b>5.8</b>	<b>Selecting the Phase Sequence for a Linear Servomotor . .</b>	<b>5-22</b>

<b>5.9</b>	<b>Polarity Sensor Setting</b> . . . . .	<b>5-24</b>
<b>5.10</b>	<b>Polarity Detection</b> . . . . .	<b>5-25</b>
5.10.1	Restrictions . . . . .	5-25
5.10.2	Using the SV_ON (Servo ON) Command to Perform Polarity Detection . . . . .	5-26
5.10.3	Using a Tool Function to Perform Polarity Detection . . . . .	5-27
<b>5.11</b>	<b>Overtravel and Related Settings</b> . . . . .	<b>5-28</b>
5.11.1	Overtravel Signals . . . . .	5-29
5.11.2	Setting to Enable/Disable Overtravel . . . . .	5-29
5.11.3	Motor Stopping Method for Overtravel . . . . .	5-30
5.11.4	Overtravel Warnings . . . . .	5-31
<b>5.12</b>	<b>Holding Brake</b> . . . . .	<b>5-33</b>
5.12.1	Brake Operating Sequence . . . . .	5-33
5.12.2	/BK (Brake) Signal . . . . .	5-34
5.12.3	Output Timing of /BK (Brake) Signal When the Servomotor Is Stopped . . . . .	5-35
5.12.4	Output Timing of /BK (Brake) Signal When the Servomotor Is Operating . . . . .	5-36
<b>5.13</b>	<b>Motor Stopping Methods for Servo OFF and Alarms</b> . . . . .	<b>5-38</b>
5.13.1	Stopping Method for Servo OFF . . . . .	5-38
5.13.2	Servomotor Stopping Method for Alarms . . . . .	5-39
<b>5.14</b>	<b>Motor Overload Detection Level</b> . . . . .	<b>5-41</b>
5.14.1	Detection Timing for Overload Warnings (A.910) . . . . .	5-41
5.14.2	Detection Timing for Overload Alarms (A.720) . . . . .	5-42
<b>5.15</b>	<b>Electronic Gear Settings</b> . . . . .	<b>5-43</b>
5.15.1	Electronic Gear Ratio Settings . . . . .	5-44
5.15.2	Electronic Gear Ratio Setting Examples . . . . .	5-47
<b>5.16</b>	<b>Resetting the Absolute Encoder</b> . . . . .	<b>5-48</b>
5.16.1	Precautions on Resetting . . . . .	5-48
5.16.2	Preparations . . . . .	5-48
5.16.3	Applicable Tools . . . . .	5-49
5.16.4	Operating Procedure . . . . .	5-49
<b>5.17</b>	<b>Setting the Origin of the Absolute Encoder</b> . . . . .	<b>5-51</b>
5.17.1	Absolute Encoder Origin Offset . . . . .	5-51
5.17.2	Setting the Origin of the Absolute Linear Encoder . . . . .	5-51
<b>5.18</b>	<b>Setting the Regenerative Resistor Capacity</b> . . . . .	<b>5-54</b>

## 5.1 Manipulating Parameters (Pn□□□)

This section describes the classifications, notation, and setting methods for the parameters given in this manual.

### 5.1.1 Parameter Classification

There are the following two types of SERVOPACK parameters.

Classification	Meaning
Setup Parameters	Parameters for the basic settings that are required for operation.
Tuning Parameters	Parameters that are used to adjust servo performance.



Important

When you edit parameters with the SigmaWin+, setup parameters and tuning parameters are displayed.

When you edit parameters with a Digital Operator, only setup parameters are displayed by default. To edit tuning parameters, set Pn00B to n.0001 (Display all parameters).

Parameter	Meaning	When Enabled	Classification
Pn00B	n.□□□0 (default setting)	After restart	Setup
	n.□□□1		

The setting method for each type of parameter is described below.

### Setup Parameters

You can use the Digital Operator, or SigmaWin+ to set the setup parameters individually.

#### Information

We recommend that you use the Setup Wizard of the SigmaWin+ to easily set the required setup parameters by setting the operating methods, machine specifications, and I/O signals according to on-screen Wizard instructions.

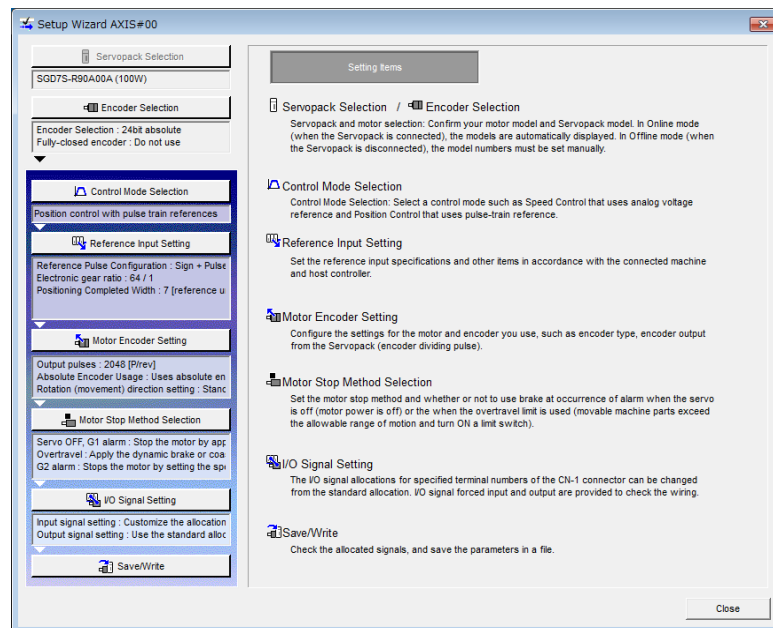

## Tuning Parameters

Normally the user does not need to set the tuning parameters individually.

Use the various SigmaWin+ tuning functions to set the related tuning parameters to increase the response even further for the conditions of your machine. Refer to the following sections for details.

- 📖 8.6 Autotuning without Host Reference on page 8-24
- 📖 8.7 Autotuning with a Host Reference on page 8-35
- 📖 8.8 Custom Tuning on page 8-43

You can also set the tuning parameters individually to make adjustments. Refer to the following section for details.

- 📖 8.13 Manual Tuning on page 8-82

## 5.1.2 Notation for Parameters

There are two types of notation used for parameters that depend on whether the parameter requires a numeric setting (parameter for numeric setting) or requires the selection of a function (parameter for selecting a function).

### Parameters for Numeric Settings

The control methods for which the parameters apply are given.  
Speed : Speed control   Position : Position control   Torque : Torque control

Pn100	Speed Loop Gain					<input type="checkbox"/> Speed <input type="checkbox"/> Position
	Setting Range	Setting Unit	Default Setting	When Enabled	Classification	
	10 to 20,000	0.1 Hz	400	Immediately	Tuning	

If All Axes is given here, the parameter applies to both axes A and B. If you change the setting, the new setting will be applied to both axes.

This is the setting range for the parameter.

This is the minimum unit (setting increment) that you can set for the parameter.

This is the parameter setting before shipment.

This is when any change made to the parameter will become effective.

This is the parameter classification.

### Parameters for Selecting Functions

Parameter number

Parameter	Meaning	When Enabled	Classification
Pn00F <input type="checkbox"/> All Axes	n.□□□0 (default setting)	After restart	Setup
	n.□□□1		

The notation "n.□□□□" indicates a parameter for selecting functions. Each □ indicates the setting for one digit. The notation shown here means that the first digit from the right is set to 1.



This column explains the selections for the function.

If All Axes is given here, the parameter applies to both axes A and B. If you change the setting, the new setting will be applied to both axes.

## 5.1.3 Parameter Setting Methods

You can use the SigmaWin+ or a Digital Operator to set parameters.  
A sample operating procedure is given below.

### Setting Parameters with the SigmaWin+

1. Click the  Servo Drive Button in the workspace of the Main Window of the SigmaWin+.
2. Select **Edit Parameters** in the Menu Dialog Box.  
The Parameter Editing Dialog Box will be displayed.
3. Click the cell of the parameter to edit.  
If the parameter to edit is not displayed in the Parameter Editing Dialog Box, click the  or  Button to display the parameter to edit.

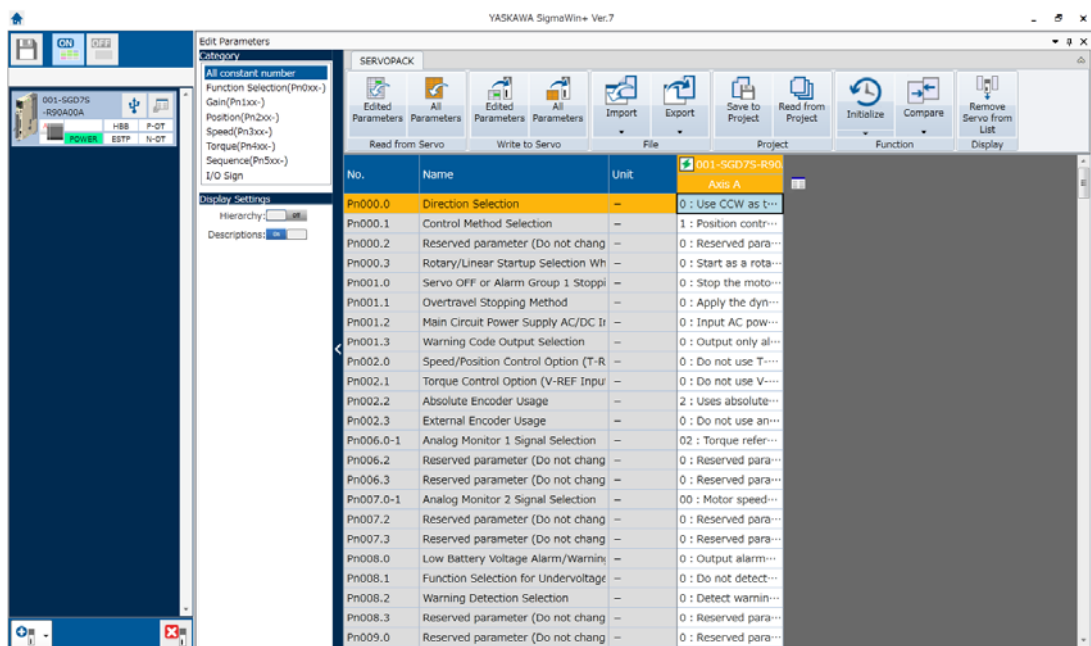

4. Change the setting of the parameter.
 

Information

  1. For a parameter for a numeric setting, input the numeric setting.
  2. If the parameter requires selection of a function, select the function from the list of selections.
5. Press the **Enter Key**.  
The background of the edited parameter cell will change to green.

5.1 Manipulating Parameters (Pn□□□)

5.1.4 Write Prohibition Setting for Parameters

6. Select Edited Parameters in the Write to Servo Group.

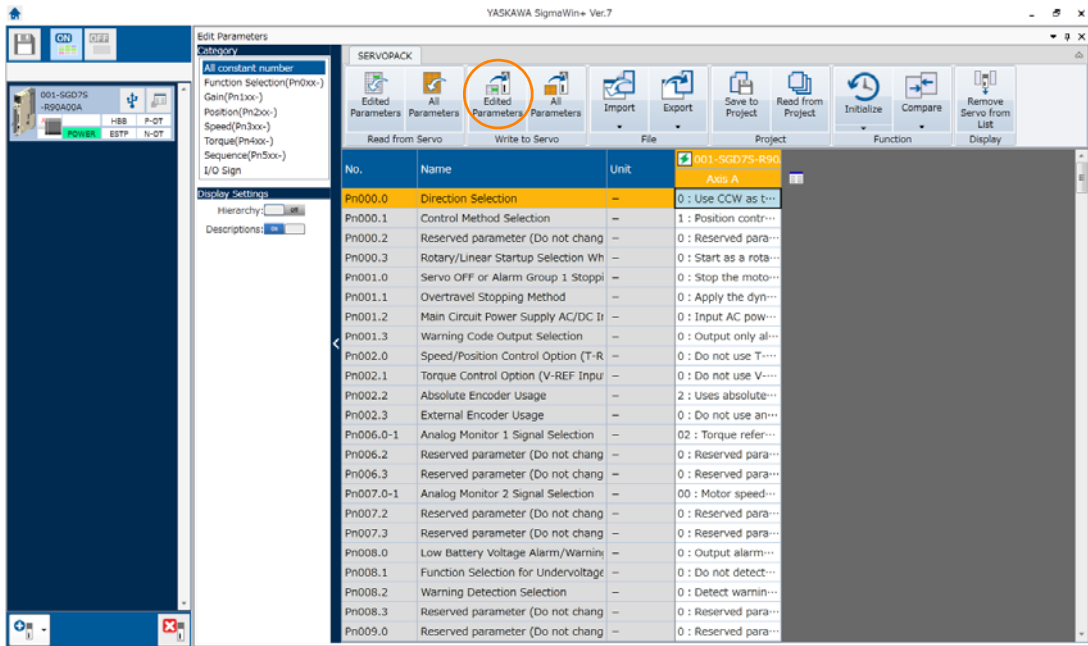

The edited parameters are written to the SERVOPACK and the backgrounds of the cells change to white.

7. Click the OK Button.

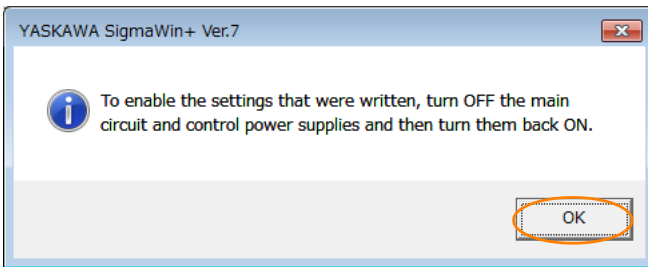

8. To enable changes to the settings, turn the power supply to the SERVOPACK OFF and ON again.

This concludes the procedure to set the parameters.

### Setting Parameters with a Digital Operator

Refer to the following manual for information on setting the parameters with a Digital Operator.

Σ-7-Series Digital Operator Operating Manual (Manual No.: SIEP S800001 33)

## 5.1.4 Write Prohibition Setting for Parameters

You can prohibit writing parameters from the Digital Operator. Even if you do, you will still be able to change parameter settings from the SigmaWin+.





**Important** The write prohibition setting for parameters applies to both axes A and B. If you change the setting, the new setting will be applied to both axes.

### Preparations

No preparations are required.



## Applicable Tools

The following table lists the tools that you can use to change the Write Prohibition Setting and the applicable tool functions.

Tool	Function	Reference
Digital Operator	Fn010	 $\Sigma$ -7-Series Digital Operator Operating Manual (Manual No.: SIEP S80001 33)
SigmaWin+	<b>Setup - Write Prohibited Setting</b>	 Operating Procedure on page 5-7

## Operating Procedure

Use the following procedure to prohibit or permit writing parameter settings.

1. Click the  Servo Drive Button in the workspace of the Main Window of the SigmaWin+.
2. Select **Write Prohibition Setting** in the Menu Dialog Box.  
The Write Prohibition Setting Dialog Box will be displayed.
3. Press the  or  for the rightmost digit and set one of the following.  
0000: Writing is permitted (default setting).  
0001: Writing is prohibited.

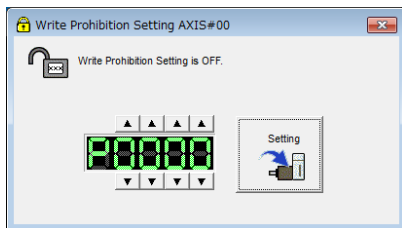

4. Click the **Setting** Button.

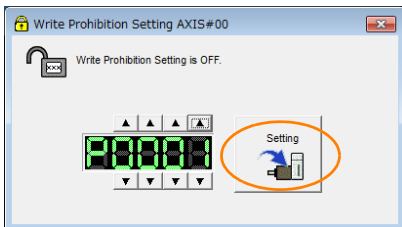

5. Click the **OK** Button.  
The setting will be written to the SERVOPACK.

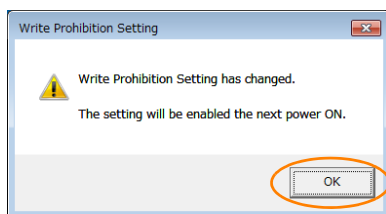

6. To enable the new setting, turn the power supply to the SERVOPACK OFF and ON again.

This concludes the procedure to prohibit or permit writing parameter settings.

## Restrictions

If you prohibit writing parameter settings, you will no longer be able to execute some functions. Refer to the following table.

5.1 Manipulating Parameters (Pn□□□)

5.1.4 Write Prohibition Setting for Parameters

SigmaWin+		Digital Operator		When Writing Is Prohibited	Reference
Button in Menu Dialog Box	SigmaWin+ Function Name	Fn No.	Utility Function Name		
Setup	Origin Search	Fn003	Origin Search	Cannot be executed.	page 7-20
	Absolute Encoder Reset	Fn008	Reset Absolute Encoder	Cannot be executed.	page 5-49
	Adjusting the Analog Monitor Output	Fn00C	Adjust Analog Monitor Output Offset	Cannot be executed.	page 9-8
		Fn00D	Adjust Analog Monitor Output Gain	Cannot be executed.	page 9-8
	Motor Current Detection Offset Adjustment	Fn00E	Autotune Motor Current Detection Signal Offset	Cannot be executed.	page 6-41
		Fn00F	Manually Adjust Motor Current Detection Signal Offset	Cannot be executed.	
	Multiturn Limit Setting	Fn013	Multiturn Limit Setting after Multiturn Limit Disagreement Alarm	Cannot be executed.	page 6-30
	Vibration Detection Level Initialization	Fn01B	Initialize Vibration Detection Level	Cannot be executed.	page 6-37
	Set Origin	Fn020	Set Absolute Linear Encoder Origin	Cannot be executed.	page 5-51
	Software Reset	Fn030	Software Reset	Can be executed.	page 6-34
	Polarity Detection	Fn080	Polarity Detection	Cannot be executed.	page 5-27
Tuning-less Level Setting	Fn200	Tuning-less Level Setting	Cannot be executed.	page 8-16	
EasyFFT	Fn206	Easy FFT	Cannot be executed.	page 8-97	
Parameters	Initialize *	Fn005	Initialize Parameters	Cannot be executed.	page 5-9
Tuning	Autotuning without Reference Input	Fn201	Advanced Autotuning without Reference	Cannot be executed.	page 8-24
	Autotuning with Reference Input	Fn202	Advanced Autotuning with Reference	Cannot be executed.	page 8-35
	Custom Tuning	Fn203	One-Parameter Tuning	Cannot be executed.	page 8-43
	Anti-Resonance Control Adjustment	Fn204	Adjust Anti-resonance Control	Cannot be executed.	page 8-52
	Vibration Suppression	Fn205	Vibration Suppression	Cannot be executed.	page 8-57
Monitor	Product Information	Fn011	Display Servomotor Model	Can be executed.	page 9-2
		Fn012	Display Software Version	Can be executed.	
		Fn01E	Display SERVOPACK and Servomotor IDs	Can be executed.	page 9-2
Test Operation	Jogging	Fn002	Jog	Cannot be executed.	page 7-7
	Program Jogging	Fn004	Jog Program	Cannot be executed.	page 7-14
Alarm	Alarm Display	Fn000	Display Alarm History	Can be executed.	page 10-39
		Fn006	Clear Alarm History	Cannot be executed.	page 10-40
	Reset Motor Type Alarm	Fn021	Reset Motor Type Alarm	Cannot be executed.	page 5-15

\* An **Initialize** Button will be displayed in the Parameter Editing Dialog Box.



## 5.1.5 Initializing Parameter Settings

You can return the parameters to their default settings. You can specify the axis or axes to initialize.

This function will not initialize the settings of the parameters that are adjusted for the Fn00C, Fn00D, Fn00E, and Fn00F utility functions.



To enable the new settings, turn the power supply to the SERVOPACK OFF and ON again after you complete the operation.

### Preparations

Always check the following before you initialize the parameter settings.

- The parameters must not be write prohibited.
- The servo must be OFF.

### Applicable Tools

The following table lists the tools that you can use to initialize the parameter settings and the applicable tool functions.

Tool	Function	Reference
Digital Operator	Fn005	$\Sigma$ -7-Series Digital Operator Operating Manual (Manual No.: SIEP S800001 33)
SigmaWin+	<i>Parameters - Edit Parameters</i>	<i>Operating Procedure</i> on page 5-9

### Operating Procedure

Use the following procedure to initialize the parameter settings.

1. Click the Servo Drive Button in the workspace of the Main Window of the SigmaWin+.
2. Select **Edit Parameters** in the Menu Dialog Box.  
The Parameter Editing Dialog Box will be displayed.
3. Select any parameter of the axis to initialize.
4. Click the **Initialize** Button in the **Function** Group.

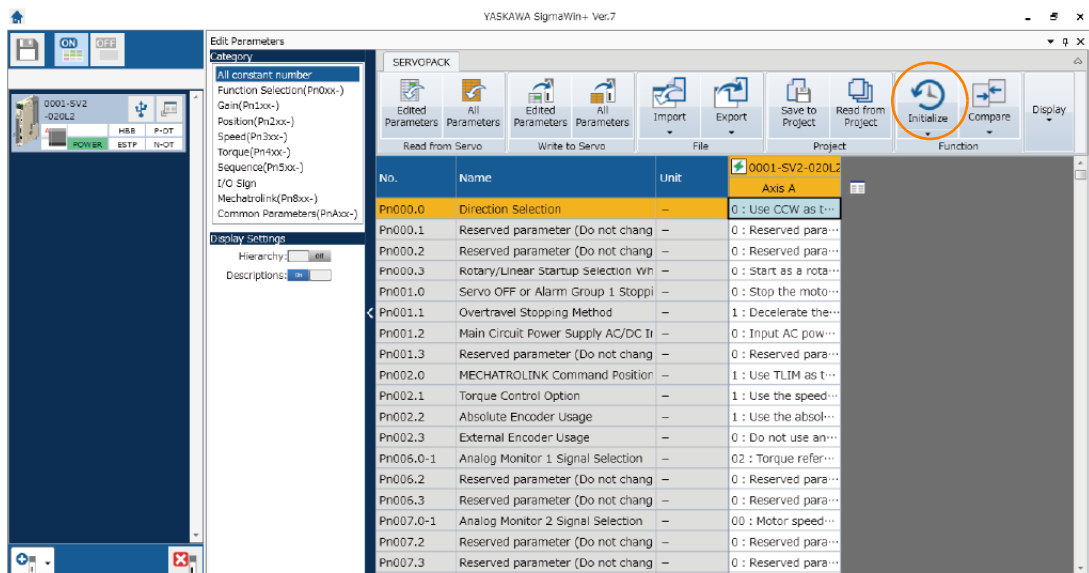

5. Click the **OK** Button.

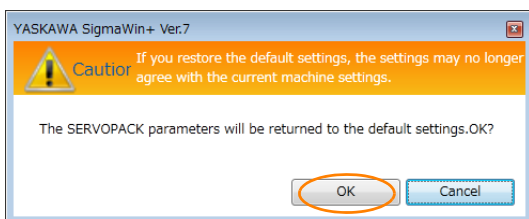

Click the **Cancel** Button to cancel initialization. The Parameter Editing Dialog Box will return.

6. Click the **OK** Button.

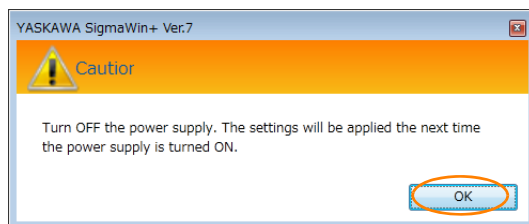

7. Turn the power supply to the SERVOPACK OFF and ON again after the parameter settings have been initialized.

This concludes the procedure to initialize the parameter settings.

## 5.2 MECHATROLINK-III Communications Settings

The settings for MECHATROLINK-III communications are made with the DIP switch (S3).  
The station address is set using the rotary switches (S1 and S2).

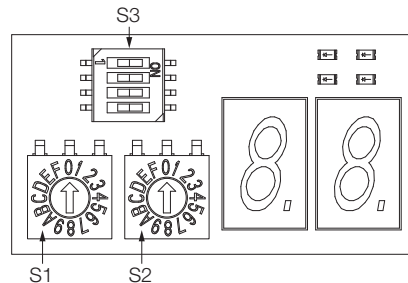

### 5.2.1 Communications Settings

Use the DIP switch (S3) to make the communications settings.

Pin No.	Function	Setting			Default Setting
		1	2	Description	
1, 2	Sets the number of transmission bytes.	OFF	OFF	Reserved. (Do not change.)	1: OFF 2: ON
		ON	OFF	32 bytes	
		OFF	ON	48 bytes	
		ON	ON	Reserved. (Do not change.)	
3	Reserved. (Do not change.)				OFF
4	Reserved. (Do not change.)				OFF



Important

- If you will use the MECHATROLINK-III standard servo profile, set the number of transmission bytes to either 32 or 48.
- To enable the new setting, turn the power supply to the SERVOPACK OFF and ON again after you change the communications switches (S1, S2, and S3).

### 5.2.2 Setting the Station Address

Use the rotary switches (S1 and S2) to set the station address.

Station Address	S1	S2
00h to 02h: Disabled (Do not set.)	0	0 to 2
03h (default setting)	0	3
04h	0	4
:	:	:
EFh	E	F
F0h to FFh: Disabled (Do not set.)	F	0 to F

## 5.2.3 Extended Address Setting

The extended addresses are given in the following table.

Axis	Extended Address	Servomotor Terminals	Encoder Connector
Axis A	00h	UA, VA, and WA	CN2A
Axis B	01h	UB, VB, and WB	CN2B

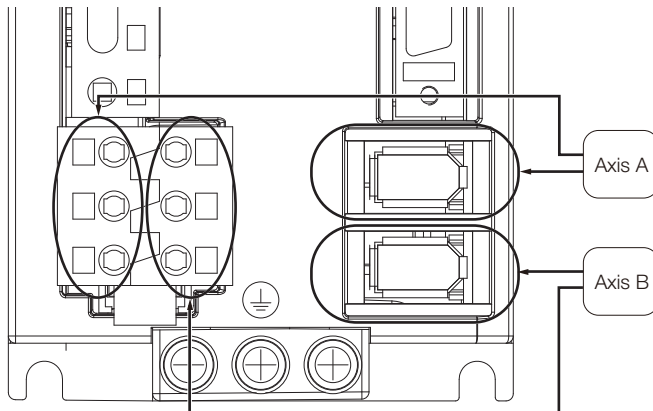

## 5.3

## Power Supply Type Settings for the Main Circuit and Control Circuit

A SERVOPACK can be operated on either an AC power supply input or DC power supply input to the main and control circuits. If you select an AC power supply input, you can operate the SERVOPACK on either a single-phase power supply input or a three-phase power supply input. This section describes the settings related to the power supplies.

## 5.3.1 AC Power Supply Input/DC Power Supply Input Setting

Set Pn001 = n.□X□□ (Main Circuit Power Supply AC/DC Input Selection) to specify whether to use an AC or DC power supply input for the main circuit power supply to the SERVOPACK. If the setting of Pn001 = n.□X□□ does not agree with the actual power supply input, an A.330 alarm (Main Circuit Power Supply Wiring Error) will occur.

**Example**

Examples of When an A.330 Alarm (Main Circuit Power Supply Wiring Error) Occurs

- A DC power supply is connected between the B1/⊕ and ⊖2 terminals, but an AC power supply input is specified (Pn001 = n.□0□□).
- An AC power supply is input to the L1, L2, and L3 terminals, but a DC power supply is specified (Pn001 = n.□1□□).

Parameter	Meaning	When Enabled	Classification
Pn001 All Axes	n.□0□□ (default setting)	After restart	Setup
	n.□1□□		

**WARNING**

- **Connect the AC or DC power supplies to the specified SERVOPACK terminals.**
  - Connect an AC power supply to the L1, L2, and L3 terminals and the L1C and L2C terminals on the SERVOPACK.
  - Connect a DC power supply to the B1/⊕ and ⊖2 terminals and the L1C and L2C terminals on the SERVOPACK.

There is a risk of failure or fire.
- **Always specify a DC power supply input (Pn001 = n.□1□□) before you input DC power for the main circuit power supply.**  
If you input DC power without specifying a DC power supply input (i.e., without setting Pn001 to n.□1□□), the SERVOPACK's internal elements may burn and may cause fire or damage to the equipment.
- **With a DC power supply input, time is required to discharge electricity after the main power supply is turned OFF. A high residual voltage may remain in the SERVOPACK after the power supply is turned OFF. Be careful not to get an electric shock.**
- **Install fuses on the power supply line if you use DC power.**
- **The Servomotor returns regenerative energy to the power supply. If you use a SERVOPACK with a DC power supply input, regenerative energy is not processed. Process the regenerative energy at the power supply.**

Refer to the following section for information on wiring the SERVOPACK.

4.3.4 Power Supply Wiring Diagrams on page 4-15

## 5.3.2 Single-phase AC Power Supply Input/Three-phase AC Power Supply Input Setting

Some models of Three-phase 200-VAC SERVOPACKs can also operate on a single-phase 200-VAC power supply.

You can use a single-phase, 200-V power supply input with the following models.

- SGD7W-1R6A, -2R8A, or -5R5A

If you use a single-phase, 200-VAC power supply input for the SERVOPACK's main circuit power supply, set parameter Pn00B to n.□1□□ (Use a three-phase power supply input as a single-phase power supply input).

Parameter		Meaning	When Enabled	Classification
Pn00B All Axes	n.□0□□ (default setting)	Use a three-phase power supply input.	After restart	Setup
	n.□1□□	Use a three-phase power supply input and as a single-phase power supply input.		



Important

1. If you use a single-phase power supply input without specifying a single-phase AC power supply (Pn00B = n.□1□□), an A.F10 alarm (Power Supply Line Open Phase) will occur.
2. Not all SERVOPACKs can be run on a single-phase AC power supply input. If you connect a single-phase AC power supply input to a SERVOPACK that does not support single-phase power, an A.F10 alarm (Power Supply Line Open Phase) will occur.
3. If you use a single-phase 200-VAC power supply input, the torque-motor speed characteristic of the Servomotor will not be the same as for a three-phase AC power supply input. Decide whether to use a single-phase or three-phase AC power supply input after checking the characteristics given in the Servomotor manual or catalog.
4. The load ratio must be derated for some SERVOPACKs when a single-phase 200-VAC power supply input is used. Refer to the following section for details.

2.1.1 Ratings on page 2-2

Refer to the following section for information on wiring a single-phase AC power supply input to the SERVOPACK.

• *Wiring Example for Single-Phase, 200-VAC Power Supply Input* on page 4-16

## 5.4

## Automatic Detection of Connected Motor

You can use a SERVOPACK to operate either a Rotary Servomotor or a Linear Servomotor. If you connect the Servomotor encoder to the CN2A or CN2B connector on the SERVOPACK, the SERVOPACK will automatically determine which type of Servomotor is connected. Therefore, you normally do not need to specify the Servomotor type.

**Information** If an encoder is not connected, e.g., for a test without a motor, you can specify a Rotary Servomotor or a Linear Servomotor in Pn000 = n.X□□□ (Rotary/Linear Startup Selection When Encoder Is Not Connected). If you specify either a Rotary or Linear Servomotor, only the parameters, monitors, alarms, and functions for the specified motor type will be enabled.

Parameter		Meaning	When Enabled	Classification
Pn000	n.0□□□ (default setting)	When an encoder is not connected, start as SERVOPACK for Rotary Servomotor.	After restart	Setup
	n.1□□□	When an encoder is not connected, start as SERVOPACK for Linear Servomotor.		

# 5.5 Motor Direction Setting

- You can reverse the direction of Servomotor rotation by changing the setting of Pn000 = n.□□□X (Rotation Direction Selection) without changing the polarity of the speed or position reference. Rotary Servomotors

The default setting for forward rotation is counterclockwise (CCW) as viewed from the load end of the Servomotor.

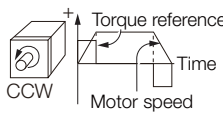
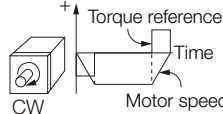
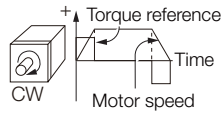
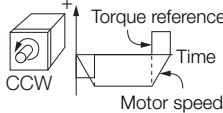
Parameter	Forward/Reverse Reference	Motor Direction	Applicable Overtravel Signal (OT)
Pn000	n.□□□0 Use CCW as the forward direction. (default setting)	Forward reference 	P-OT (Forward Drive Prohibit) signal
		Reverse reference 	N-OT (Reverse Drive Prohibit) signal
	n.□□□1 Use CW as the forward direction. (Reverse Rotation Mode)	Forward reference 	P-OT (Forward Drive Prohibit) signal
		Reverse reference 	N-OT (Reverse Drive Prohibit) signal

Note: The trace waveforms of the SigmaWin+ are shown in the above table for the torque reference and motor speed diagrams. If you measure them on a measuring instrument, e.g., with an analog monitor, the polarity will be reversed.

- Linear Servomotors

Before you set this parameter, make sure that Pn080 = n.□□X□ (Motor Phase Sequence Selection) is set correctly.

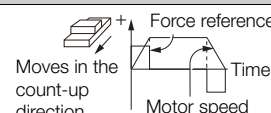
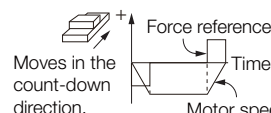
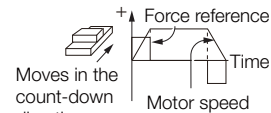
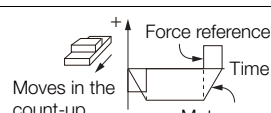
Parameter	Forward/Reverse Reference	Motor Moving Direction	Applicable Overtravel Signal (OT)
Pn000	n.□□□0 Use the direction in which the linear encoder counts up as the forward direction. (default setting)	Forward reference 	P-OT (Forward Drive Prohibit) signal
		Reverse reference 	N-OT (Reverse Drive Prohibit) signal
	n.□□□1 Use the direction in which the linear encoder counts down as the forward direction.	Forward reference 	P-OT (Forward Drive Prohibit) signal
		Reverse reference 	N-OT (Reverse Drive Prohibit) signal

Note: The trace waveforms of the SigmaWin+ are shown in the above table for the force reference and motor speed diagrams. If you measure them on a measuring instrument, e.g., with an analog monitor, the polarity will be reversed.



## 5.6

## Setting the Linear Encoder Pitch

If you connect a linear encoder to the SERVOPACK through a Serial Converter Unit, you must set the scale pitch of the linear encoder in Pn282.

If a Serial Converter Unit is not connected, you do not need to set Pn282.



Term

**Serial Converter Unit**

The Serial Converter Unit converts the signal from the linear encoder into a form that can be read by the SERVOPACK.

**Scale Pitch**

A linear encoder has a scale for measuring lengths (positions). The length of one division on this scale is the scale pitch.

Pn282	Linear Encoder Pitch				Speed	Position	Force
	Setting Range	Setting Unit	Default Setting	When Enabled	Classification		
	0 to 6,553,600	0.01 $\mu\text{m}$	0	After restart	Setup		

You will not be able to control the Linear Servomotor if Pn282 is not set correctly. Check the above table and always set the correct value before you operate the Linear Servomotor.

Type of Linear Encoder	Manufacturer	Model	Serial Converter Unit Model	Linear Encoder Pitch [ $\mu\text{m}$ ]
Incremental	Heidenhain Corporation	LIDA48□	JZDP-H003-□□□-E	20
			JZDP-J003-□□□-E	
		LIF48□	JZDP-H003-□□□-E	4
			JZDP-J003-□□□-E	
	Renishaw PLC	RGH22B	JZDP-H005-□□□-E	20
			JZDP-J005-□□□-E	

The first time you supply power to the SERVOPACK, the panel display on the front of the Servomotor will display an A.080 alarm (Linear Encoder Pitch Setting Error). The A.080 alarm is displayed because the setting of Pn282 has not been changed. The A.080 alarm will be cleared when you change the setting of Pn282 and then turn the power supply OFF and ON again.

**Information****Linear Encoder Pitch**

If you do not use a Serial Converter Unit, the linear encoder pitch is automatically set. It is not necessary to set Pn282. You can use the SigmaWin+ to check the linear encoder pitch that was automatically set. Refer to the following section for details.

9.1 Monitoring Product Information on page 9-2

# 5.7 Writing Linear Servomotor Parameters

If you connect a linear encoder to the SERVOPACK without going through a Serial Converter Unit, you must use the SigmaWin+ to write the motor parameters to the linear encoder. The motor parameters contain the information that is required by the SERVOPACK to operate the Linear Servomotor.

## ! WARNING

- Check the Servomotor and linear encoder information before you write the motor parameters. If you do not write the correct motor parameters, the Servomotor may run out of control or burning may occur, possibly resulting in equipment damage or fire.

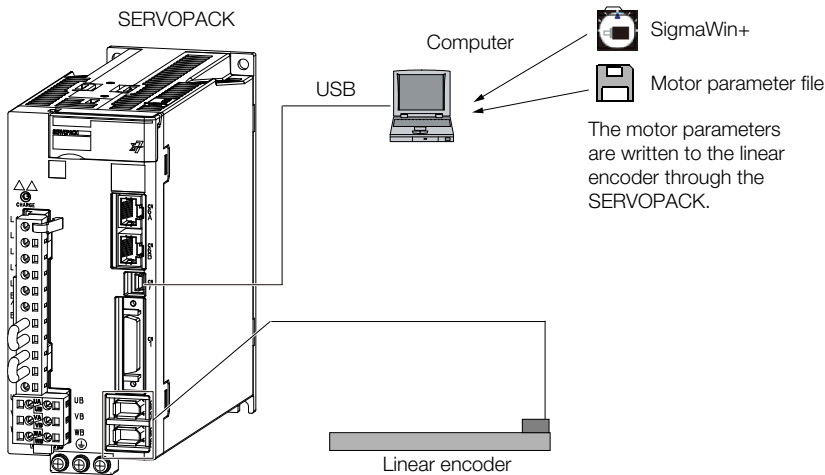

**Important** Serial number information is not included in the motor parameters. You cannot use the monitor functions of the SERVOPACK to monitor the serial number. If you attempt to monitor the serial number, \*\*\*\*\* will be displayed.

## Precautions

- If the encoder parameters are not written to the linear encoder, an A.CA0 alarm (Encoder Parameter Error) will occur. Consult the manufacturer of the linear encoder.
- If the motor parameters are not written to the linear encoder, an A.CA0 alarm (Encoder Parameter Error) will not occur, but the following alarms will occur.  
 A.040 (Parameter Setting Error), A.041 (Encoder Output Pulse Setting Error),  
 A.050 (Combination Error), A.051 (Unsupported Device Alarm),  
 A.550 (Maximum Speed Setting Error), A.710 (Instantaneous Overload),  
 A.720 (Continuous Overload), and A.C90 (Encoder Communications Error)

## Applicable Tools

The following table lists the tools that you can use to write the parameters to the Linear Servomotor and the applicable tool functions.

Tool	Function	Reference
Digital Operator	You cannot write Linear Servomotor parameters from the Digital Operator.	
SigmaWin+	<b>Setup - Motor Parameter Scale Write</b>	Operating Procedure on page 5-19

## Operating Procedure

Use the following procedure to write the motor parameters to the Linear Encoder.

1. Prepare the motor parameter file to write to the linear encoder.
2. Click the  Servo Drive Button in the workspace of the Main Window of the SigmaWin+.
3. Select **Motor Parameter Scale Write** in the Menu Dialog Box. The Motor Parameter Scale Write Dialog Box will be displayed.
4. Click the **OK** Button.

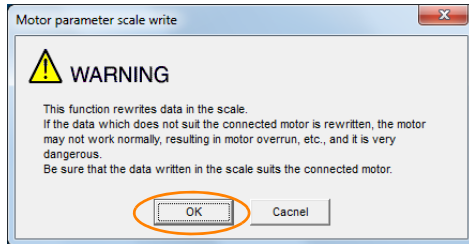

Click the **Cancel** Button to cancel writing the motor parameters to the linear encoder. The Main Window will return.

If the write is completed normally, the Motor Parameter Scale Write - File Select Dialog Box will be displayed.

5. Click the **Ref.** Button.

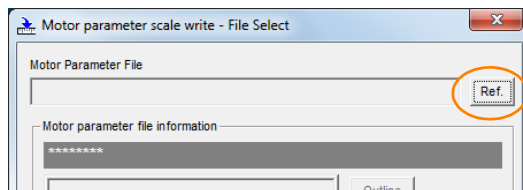

6. Select the motor parameter file that you prepared and click the **Open** Button.

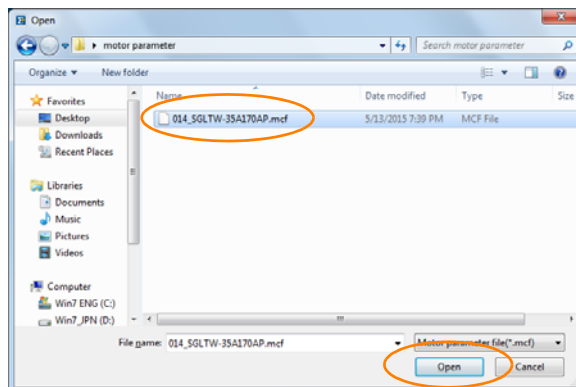

- 7. Confirm that the motor parameter file information that is displayed is suitable for your Servomotor, and then click the **Next** Button.

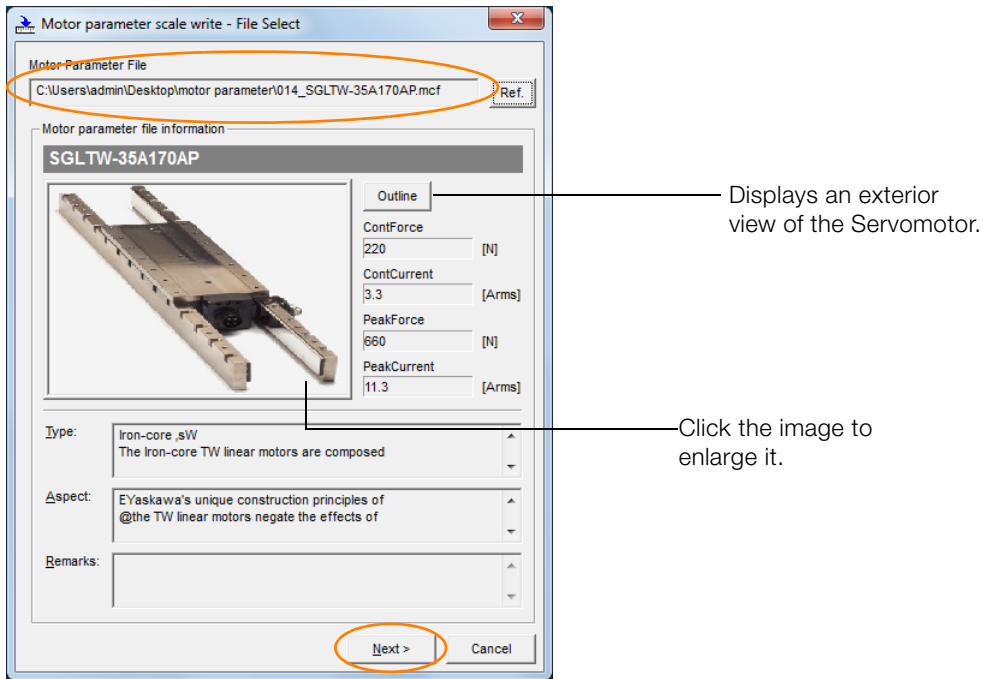

Click the **Cancel** Button to cancel writing the motor parameters to the linear encoder. The Main Window will return.

- 8. Click the **Write** Button.

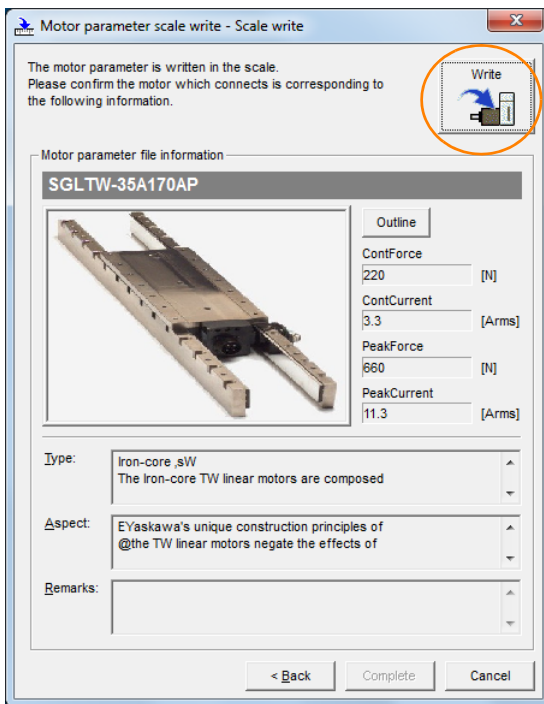

- 9. Click the **Yes** Button.

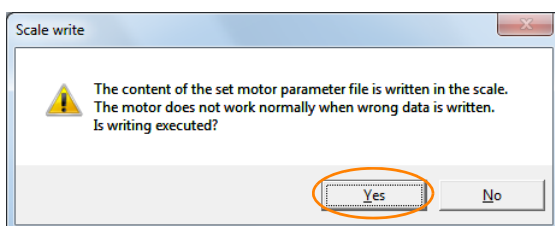

Click the **No** Button to cancel writing the motor parameters to the linear encoder. If you click the **Yes** Button, writing the motor parameter scale will start.

### 10. Click the Complete Button.

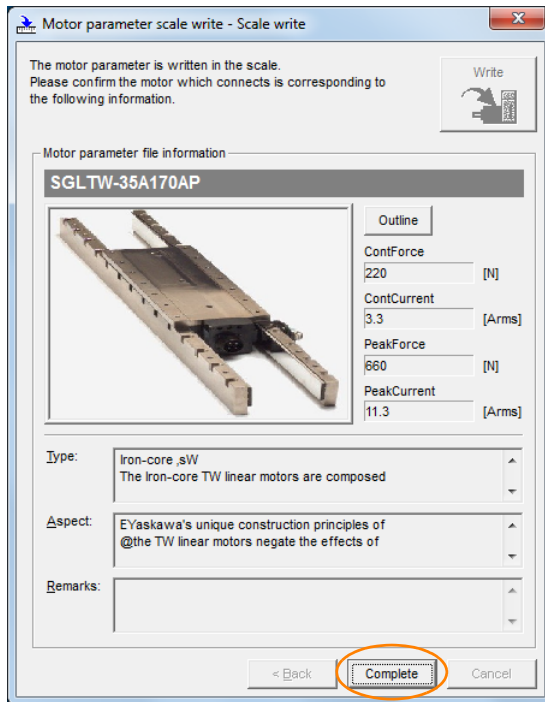

### 11. Click the OK Button.

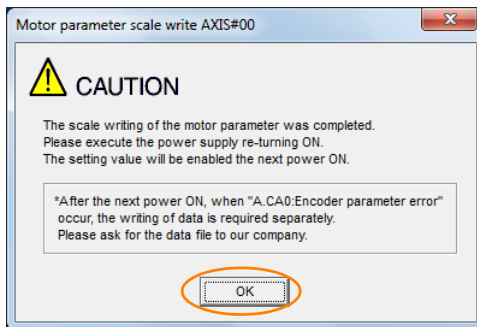

### 12. Turn the power supply to the SERVOPACK OFF and ON again.

This concludes the procedure to write the motor parameters.

## Confirming If the Motor Parameters Have Been Written

After you write the motor parameters, you can use a monitor function to confirm that the motor parameters are in the encoder.

If the motor parameters have not been written, no information on the Servomotor will be displayed.

9.1 Monitoring Product Information on page 9-2

# 5.8 Selecting the Phase Sequence for a Linear Servomotor

You must select the phase sequence of the Linear Servomotor so that the forward direction of the Linear Servomotor is the same as the encoder's count-up direction.

Before you set the Linear Servomotor phase sequence (Pn080 = n.□□X□), check the following items.

- Confirm that the signal from the linear encoder is being received normally.
- Make sure that the forward direction of the Linear Servomotor and the count-up direction of the linear encoder are in the same direction.



**Important** If you do not confirm the above items before you attempt to operate the Servomotor, the Servomotor may not operate or it may run out of control. Always confirm these items before you operate the Servomotor.

• **Related Parameters**

Parameter	Meaning	When Enabled	Classification
Pn080	n.□□0□ (default setting)	After restart	Setup
	n.□□1□		

• **Setting Procedure**

- 1. Set Pn000 to n.□□□0 (Set a phase-A lead as a phase sequence of U, V, and W).**  
This setting is to make following confirmation work easier to understand.
- 2. Select Monitor in the Menu Dialog Box.**  
The Operation Pane will be displayed so that you can check the feedback pulse counter. To check the feedback pulse counter with the Digital Operator, use Un00D (Feedback Pulse Counter).
- 3. Manually move the Moving Coil from one end to the other of the stroke and confirm that only the correct number of feedback pulses is returned.**  
If the correct number and only the correct number of pulses is returned, the signal is being received correctly from the linear encoder.

**Example** In this example, assume that a linear encoder with a scale pitch of 20 μm and a resolution of 256 is used. If you manually move the Moving Coil 1 cm in the count-up direction of the linear encoder, the number of feedback pulses would be as follows:  
 $1 \text{ cm} / (20 \text{ μm} / 256) = 128,000 \text{ pulses}$

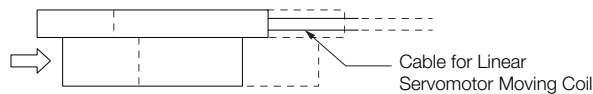

If there are 128,000 pulses on the feedback pulse counter after you manually move the Moving Coil in the direction of the cable, you have completed the confirmation.

**Note:** The actual monitor display will be offset by the error in the travel distance. There is no problem as long as the above value is close to the calculated value.

**Information**

If the correct value is not displayed for the feedback pulse counter, the following conditions may exist. Check the situation and correct any problems.

- The linear encoder pitch is not correct.  
If the scale pitch that is set in Pn282 does not agree with the actual scale pitch, the expected number of feedback pulses will not be returned. Check the specifications of the linear encoder.
- The linear encoder is not adjusted properly.  
If the linear encoder is not adjusted properly, the output signal level from the linear encoder will drop and the correct number of pulses will not be counted. Check the adjustment of the linear encoder. Contact the manufacturer of the linear encoder for details.
- There is a mistake in the wiring between the linear encoder and the Serial Converter Unit.
- If the wiring is not correct, the correct number of pulses will not be counted. Correct the wiring.

4. Manually move the Moving Coil in the direction of the cable and check the value of the feedback pulse counter in the Operation Pane to confirm that it is counting up.

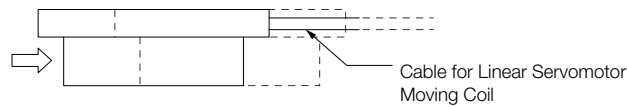

Manually move the Moving Coil in the direction of the cable.

5. If the feedback pulse counter counts up, set a phase-A lead as a phase sequence of U, V, and W (Pn080 = n.□□0□).  
If the feedback pulse counter counts down, set a phase-B lead as a phase sequence of U, V, and W (Pn080 = n.□□1□).
6. Turn the power supply to the SERVOPACK OFF and ON again.
7. If necessary, return Pn000 = n.□□□X (Direction Selection) to its original setting.

This concludes the procedure to set the phase sequence of the Linear Servomotor.

## 5.9 Polarity Sensor Setting

The polarity sensor detects the polarity of the Servomotor. You must set a parameter to specify whether the Linear Servomotor that is connected to the SERVOPACK has a polarity sensor. Specify whether there is a polarity sensor in Pn080 = n.□□□X (Polarity Sensor Selection).

If the Linear Servomotor has a polarity sensor, set Pn080 to n.□□□0 (Use polarity sensor) (default setting).

If the Linear Servomotor does not have a polarity sensor, set Pn080 to n.□□□1 (Do not use polarity sensor). Turn the power supply OFF and ON again to enable the new setting.

	Parameter	Meaning	When Enabled	Classification
Pn080	n.□□□0 (default setting)	Use polarity sensor.	After restart	Setup
	n.□□□1	Do not use polarity sensor.		

### Information

If you set Pn080 to n.□□□0 (Use polarity sensor) and the Linear Servomotor that is connected to the SERVOPACK does not have a polarity sensor, an A.C21 alarm (Polarity Sensor Error) will occur when you turn the power supply OFF and ON again.



## 5.10 Polarity Detection

If you use a Linear Servomotor that does not have a polarity sensor, then you must detect the polarity.

Detecting the polarity means that the position of the electrical phase angle on the electrical angle coordinates of the Servomotor is detected. The SERVOPACK cannot control the Servomotor correctly unless it accurately knows the position of the electrical angle coordinate of the Servomotor.

The execution timing and execution method for polarity detection depend on the encoder specification as described in the following table.

Encoder Specification	Polarity Detection Execution Timing	Polarity Detection Execution Method
Incremental encoder	Each time the control power supply to the SERVOPACK is turned ON  (Even after you execute polarity detection, the position of the polarity will be lost the next time the control power supply to the SERVOPACK is turned OFF.)	<ul style="list-style-type: none"> <li>• Use the SV_ON (Servo ON) command.</li> <li>• Use the polarity detection function of the SigmaWin+.</li> <li>• Execute the Fn080 (Polarity Detection) utility function from the Digital Operator.</li> </ul>
Absolute encoder	Only for initial setup, or after the SERVOPACK, linear encoder, or Servomotor has been replaced  (The results of polarity detection is stored in the absolute encoder, so the polarity position is not lost when the control power supply is turned OFF.)	<ul style="list-style-type: none"> <li>• Use the polarity detection function of the SigmaWin+.</li> <li>• Execute the Fn080 (Polarity Detection) utility function from the Digital Operator.</li> <li>• Use Pn587 (Absolute Linear Encoder Polarity Detection Selection).</li> </ul>

**Information** If you use a Linear Servomotor that does not have a polarity sensor, you will not be able to turn ON the servo until polarity detection has been completed.

### 5.10.1 Restrictions

#### Assumed Conditions

The Servomotor will move when you execute polarity detection. The following conditions must be met before you start.

- It must be OK to move the Moving Coil about 10 mm.  
(If polarity detection fails, the Moving Coil may move approximately 5 cm. The amount of movement depends on conditions.)
- The linear encoder pitch must be 100  $\mu\text{m}$  or less. (We recommend a pitch of 40  $\mu\text{m}$  or less for an incremental encoder.)
- As much as possible, the motor must not be subjected to an imbalanced external force. (We recommend 5% or less of the rated force.)
- The mass ratio must be 50x or less.
- The axis must be horizontal.
- There must be friction equivalent to a few percent of the rated force applied to the guides. (Air sliders cannot be used.)

## Preparations

Always check the following before you execute polarity detection.

- Not using a polarity sensor must be specified (Pn080 = n.□□□1).
- The servo must be OFF for both axis A and axis B.
- The main circuit power supply must be ON.
- There must be no alarms except for an A.C22 alarm (Phase Information Disagreement).
- The parameters must not be write prohibited. (This item applies only when using the SigmaWin+ or Digital Operator.)
- The test without a motor function must be disabled (Pn00C = n.□□□0).
- There must be no overtravel.
- If the motor parameters have been written or the origin of the absolute linear encoder has been set, the power supply to the SERVOPACK must be turned OFF and ON again after completion of the writing or setting operation.



Important

1. Power is supplied to the Servomotor during polarity detection. Be careful not to get an electric shock. Also, the Moving Coil of the Linear Servomotor may greatly move during detection. Do not approach the moving parts of the Servomotor.
2. Polarity detection is affected by many factors. For example, polarity detection may fail if the mass ratio or friction is too large or the cable tension is too strong.

## 5.10.2 Using the SV\_ON (Servo ON) Command to Perform Polarity Detection

You can use the SV\_ON (Servo ON) command to perform polarity detection only with an incremental linear encoder.

Polarity detection will be performed when you turn the control power supply to the SERVOPACK OFF and then ON again, and then send the SV\_ON (Servo ON) command. As soon as polarity detection is completed, the /S-RDY (Servo Ready) signal will turn ON.

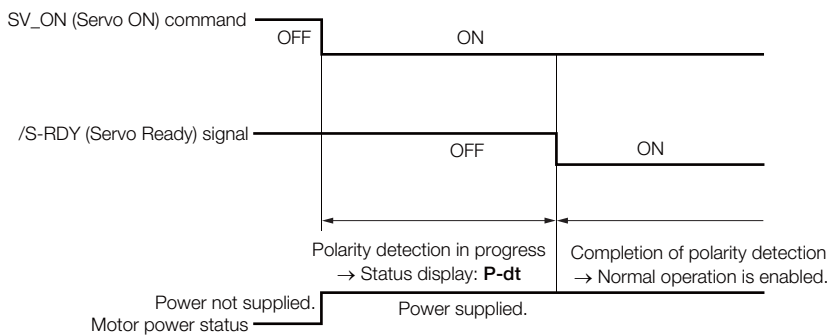

Polarity detection will start simultaneously with execution of the SV\_ON (Servo ON) command. As soon as polarity detection is completed, the /S-RDY will turn ON and the servo will remain ON.



## 5.10.3 Using a Tool Function to Perform Polarity Detection

### Applicable Tools

The following table lists the tools that you can use to perform polarity detection and the applicable tool functions.

Tool	Function	Reference
Digital Operator	Fn080	 $\Sigma$ -7-Series Digital Operator Operating Manual (Manual No.: SIEP S800001 33)
SigmaWin+	<b>Setup - Polarity Detection</b>	 Operating Procedure on page 5-27

### Operating Procedure

Use the following procedure to perform polarity detection.

1. Click the  Servo Drive Button in the workspace of the Main Window of the SigmaWin+.
2. Select **Polarity Detection** in the Menu Dialog Box.  
The Polarity Detection Dialog Box will be displayed.
3. Click the **Continue** Button.

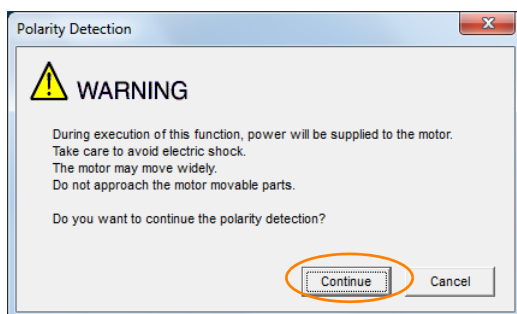

Click the **Cancel** Button to cancel polarity detection. The Main Window will return.

4. Click the **Start** Button.  
Polarity detection will be executed.

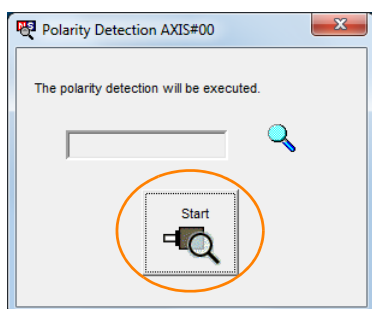

This concludes the polarity detection procedure.

# 5.11 Overtravel and Related Settings

Overtravel is a function of the SERVOPACK that forces the Servomotor to stop in response to a signal input from a limit switch that is activated when a moving part of the machine exceeds the safe range of movement.

The overtravel signals include the P-OT (Forward Drive Prohibit) and the N-OT (Reverse Drive Prohibit) signals.

You use the P-OT and N-OT signals to stop the machine by installing limit switches at the positions where you want to stop the machine that is operated by the Servomotor.

A SERVOPACK wiring example is provided below.

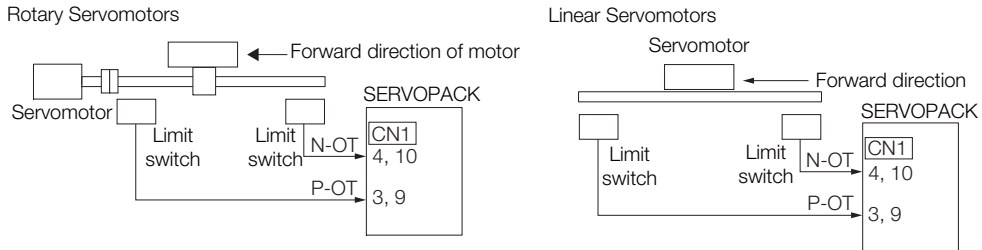

Using the overtravel function is not necessary for rotating applications such as rotary tables and conveyors. No wiring for overtravel input signals is required.

This section describes the parameters settings related to overtravel.

## ⚠ CAUTION

- To prevent accidents that may result from contact faults or disconnections, use normally closed limit switches.  
Do not change the default settings of the polarity of the overtravel signals (P-OT and N-OT).
- If you use a Servomotor for a vertical axis, the /BK (Brake) signal will remain ON (i.e., the brake will be released) when overtravel occurs. This may result in the workpiece falling when overtravel occurs. To prevent the workpiece from falling, set Pn001 to n.□□1□ to place the Servomotor in a zero-clamped state when it stops.
- A base block state is entered after stopping for overtravel. This may cause the Servomotor to be pushed back by an external force on the load shaft. To prevent the Servomotor from being pushed back, set Pn001 to n.□□1□ to place the Servomotor in a zero-clamped state when it stops.

## 5.11.1 Overtravel Signals

The overtravel signals include the P-OT (Forward Drive Prohibit) and the N-OT (Reverse Drive Prohibit) signals.

Type	Signal	Connector Pin No.	Signal Status	Meaning
Input	P-OT	Axis A: CN1-3 Axis B: CN1-9	ON	Forward drive is enabled (actual operation).
			OFF	Forward drive is prohibited (forward overtravel).
	N-OT	Axis A: CN1-4 Axis B: CN1-10	ON	Reverse drive is enabled (actual operation).
			OFF	Reverse drive is prohibited (reverse overtravel).

You can operate the Servomotor in the opposite direction during overtravel by inputting a reference.

## 5.11.2 Setting to Enable/Disable Overtravel

You can use Pn50A = n.X□□□ (P-OT (Forward Drive Prohibit) Signal Allocation) and Pn50B = n.□□□X (N-OT (Reverse Drive Prohibit) Signal Allocation) to enable and disable the overtravel function.

You do not need to wire the overtravel input signals if you are not going to use the overtravel function.

Parameter		Meaning	When Enabled	Classification
Pn50A	n.0□□□ (default setting)	The forward overtravel function is enabled and the P-OT (Forward Drive Prohibit) signal is input from CN1-3 for axis A and CN1-9 for axis B.	After restart	Setup
	n.8□□□	The reverse overtravel function is disabled. Forward drive is always enabled.		
Pn50B	n.□□□1 (default setting)	The reverse overtravel function is enabled and the N-OT (Reverse Drive Prohibit) signal is input from CN1-4 for axis A and CN1-10 for axis B.		
	n.□□□8	The reverse overtravel function is disabled. Reverse drive is always enabled.		

You can also use Pn590 (P-OT (Forward Drive Prohibit) Signal Allocation) and Pn591 (N-OT (Reverse Drive Prohibit) Signal Allocation) to enable and disable the overtravel function. Refer to the following sections for details.

 6.1.1 Input Signal Allocations on page 6-3

 11.1.2 List of Servo Parameters on page 11-3

You can allocate the P-OT and N-OT signals to other connector pins. Refer to the following section for details.

 6.1.1 Input Signal Allocations on page 6-3

### 5.11.3 Motor Stopping Method for Overtravel

You can set the stopping method of the Servomotor when overtravel occurs in Pn001 = n.□□XX (Servo OFF or Alarm Group 1 Stopping Method and Overtravel Stopping Method).

Parameter		Motor Stopping Method*	Status after Stopping	When Enabled	Classification
Pn001	n.□□00 (default setting)	Dynamic brake	Coasting	After restart	Setup
	n.□□01				
	n.□□02	Coasting			
	n.□□1□	Deceleration according to setting of Pn406	Zero clamp		
	n.□□2□		Coasting		
	n.□□3□	Deceleration according to setting of Pn30A	Zero clamp		
	n.□□4□		Coasting		

\* You cannot decelerate a Servomotor to a stop during torque control. For torque control, the Servomotor will be stopped with the dynamic braking or coast to a stop (according to the setting of Pn001 = n.□□XX (Servo OFF or Alarm Group 1 Stopping Method)), and then the Servomotor will enter a coasting state.

Refer to the following section for information on stopping methods other than those for overtravel.

 5.13.1 Stopping Method for Servo OFF on page 5-38

### Stopping the Servomotor by Setting Emergency Stop Torque

To stop the Servomotor by setting emergency stop torque, set Pn406 (Emergency Stop Torque).

If Pn001 = n.□□X□ is set to 1 or 2, the Servomotor will be decelerated to a stop using the torque set in Pn406 as the maximum torque.

The default setting is 800%. This setting is large enough to allow you to operate the Servomotor at the maximum torque. However, the maximum emergency stop torque that you can actually use is the maximum torque of the Servomotor.

Pn406	Emergency Stop Torque				Speed	Position
	Setting Range	Setting Unit	Default Setting	When Enabled	Classification	
	0 to 800	1%*	800	Immediately	Setup	

\* Set a percentage of the motor rated torque.

### Stopping the Servomotor by Setting the Deceleration Time

To specify the Servomotor deceleration time and use it to stop the Servomotor, set Pn30A (Deceleration Time for Servo OFF and Forced Stops).

Pn30A	Deceleration Time for Servo OFF and Forced Stops				Speed	Position
	Setting Range	Setting Unit	Default Setting	When Enabled	Classification	
	0 to 10,000	1 ms	0	Immediately	Setup	

If you set Pn30A to 0, the Servomotor will be stopped with a zero speed.

The deceleration time that you set in Pn30A is the time to decelerate the Servomotor from the maximum motor speed.

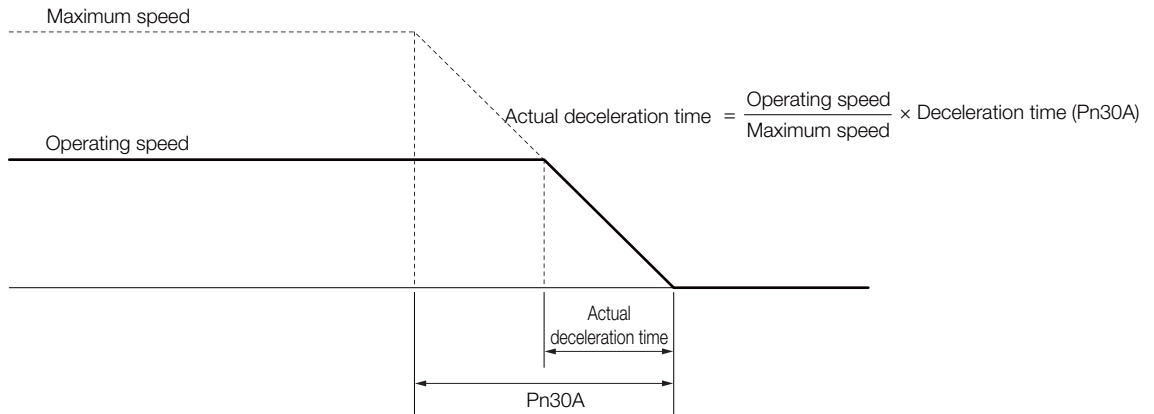

## 5.11.4 Overtravel Warnings

You can set the system to detect an A.9A0 warning (Overtravel) if overtravel occurs while the servo is ON. This allows the SERVOPACK to notify the host controller with a warning even when the overtravel signal is input only momentarily. An alarm occurs only if overtravel occurs while the servo is ON. An overtravel warning will not be detected when the servo is OFF, even if overtravel occurs.



Important

1. The occurrence of an A.9A0 warning will not stop the motor or have any affect on host control-  
 operation. The next step (e.g., the next motion or command) can be executed  
 even if an overtravel warning exists.  
 However, depending on the processing specifications and programming for warnings in the  
 host controller, operation may be affected when an overtravel warning occurs (e.g., motion  
 may stop or not stop). Confirm the specifications and programming in the host controller.
2. When overtravel occurs, the SERVOPACK will perform stop processing for overtravel. There-  
 fore, when an A.9A0 warning occurs, the Servomotor may not reach the target position speci-  
 fied by the host controller. Check the feedback position to make sure that the axis is stopped  
 at a safe position.

The following parameter is set for this function.

Parameter	Meaning	When Enabled	Classification
Pn00D	n.0□□□ (default setting)	Immediately	Setup
	n.1□□□		

A timing chart for warning detection is provided below.

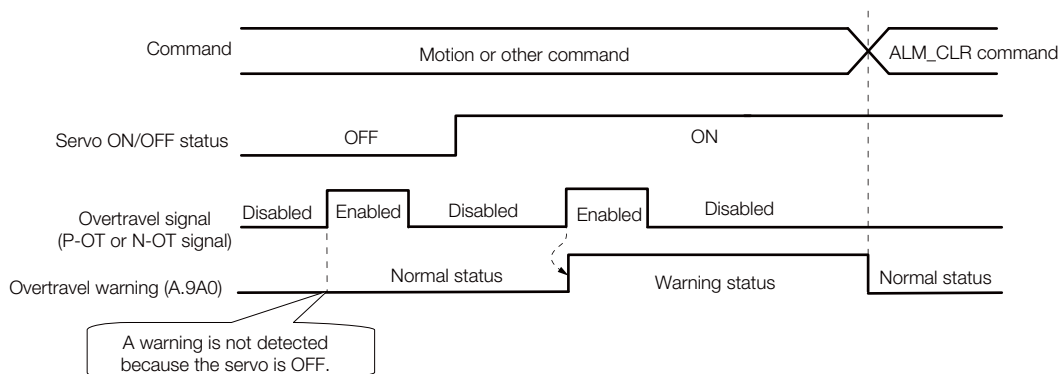

5.11.4 Overtravel Warnings

**Information**

1. Warnings are detected for overtravel in the same direction as the reference.
2. Warnings are not detected for overtravel in the opposite direction from the reference.  
Example: A warning will not be output for a forward reference even if the N-OT signal turns ON.
3. A warning can be detected in either the forward or reverse direction if there is no reference.
4. A warning will not be detected when the servo is turned ON even if overtravel status exists.
5. You can use the ALM\_CLR (Clear Alarms and Warnings) command to clear the warning regardless of the servo ON/OFF status and overtravel signal status.
6. If you clear the warning with the ALM\_CLR (Clear Alarms and Warnings) command during overtravel status, a warning will not be detected again until the overtravel status is left.
7. An overtravel warning will be detected even when the software limit has been detected.



# 5.12 Holding Brake

A holding brake is used to hold the position of the moving part of the machine when the SERVOPACK is turned OFF so that moving part does not move due to gravity or an external force. You can use the brake that is built into a Servomotor with a Brake, or you can provide one on the machine.

The holding brake is used in the following cases.

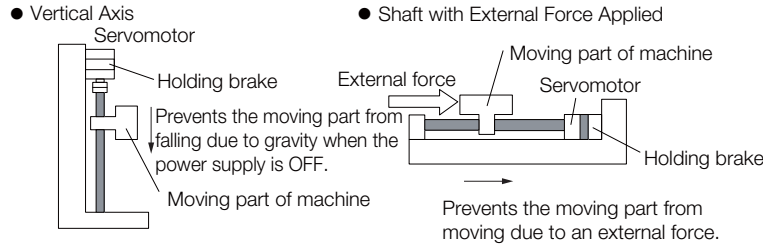



**Important** The brake built into a Servomotor with a Brake is a de-energization brake. It is used only to hold the Servomotor and cannot be used for braking. Use the holding brake only to hold a Servomotor that is already stopped.

## 5.12.1 Brake Operating Sequence

You must consider the brake release delay time and the brake operation delay time to determine the brake operation timing, as described below.



**Term**

**Brake Release Delay Time**  
The time from when the /BK (Brake) signal is turned ON until the brake is actually released.

**Brake Operation Delay Time**  
The time from when the /BK (Brake) signal is turned OFF until the brake actually operates.

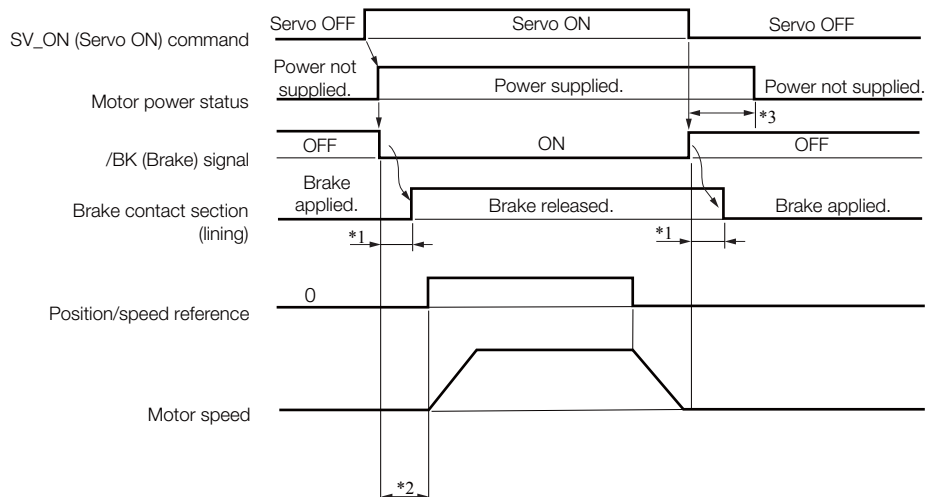

\*1. Rotary Servomotors: The brake delay times for Servomotors with Holding Brakes are given in the following table. The operation delay times in the following table are examples for when the power supply is switched on the DC side. You must evaluate the actual brake delay times on the actual equipment before using the application.

Model	Voltage	Brake Release Delay Time [ms]	Brake Operation Delay Time [ms]
SGM7M-A1 to -A3	24 VDC	60	100
SGM7J-A5 to -04			
SGM7J-06 and -08			
SGM7A-A5 to -04		80	100
SGM7A-06 and -08			
SGM7P-01		20	100
SGM7P-02 and -04		40	
SGM7P-08		20	
SGM7G-03 to -09			100

Linear Servomotors: The brake delay times depend on the brake that you use. Set the parameters related to /BK signal output timing according to the delay times for the brake that you will actually use.

- \*2. Before you output a reference from the host controller to the SERVOPACK, wait for at least 50 ms plus the brake release delay time after you send the SV\_ON command.
- \*3. Use the following parameters to set the timing of when the brake will operate and when the servo will be turned OFF.
  - Rotary Servomotors: Pn506 (Brake Reference-Servo OFF Delay Time), Pn507 (Brake Reference Output Speed Level), and Pn508 (Servo OFF-Brake Reference Waiting Time)
  - Linear Servomotors: Pn506 (Brake Reference-Servo OFF Delay Time), Pn508 (Servo OFF-Brake Reference Waiting Time), and Pn583 (Brake Reference Output Speed Level)

## Connection Examples

Refer to the following section for information on brake wiring.

 4.4.4 Wiring the SERVOPACK to the Holding Brake on page 4-31

## 5.12.2 /BK (Brake) Signal

The following settings are for the output signal that controls the brake. You can change the connector pin that is allocated. For details, refer to *Allocating the /BK (Brake) Signal*. The /BK signal is turned OFF (to operate the brake) when the servo is turned OFF or when an alarm is detected. You can adjust the timing of brake operation (i.e., the timing of turning OFF the /BK signal) with the servo OFF delay time (Pn506).

Type	Signal	Connector Pin No.	Signal Status	Meaning
Output	/BK	Axis A: CN1-23 and CN1-24	ON (closed)	Releases the brake.
		Axis B: CN1-25 and CN1-26	OFF (open)	Activates the brake.

**Information** The /BK signal will remain ON during overtravel. The brake will not be applied.

## Allocating the /BK (Brake) Signal

Set the allocation for the /BK signal in Pn50F = n.□X□□ (/BK (Brake Output) Signal Allocation).

- Axis A

Parameter	Connector Pin No.		Meaning	When Enabled	Classification	
	+ Pin	- Pin				
Pn50F	n.□0□□	–	–	The /BK signal is not used.	After restart	Setup
	n.□1□□ (default setting)	CN1-23	CN1-24	The /BK signal is output from CN1-23 and CN1-24.		
	n.□2□□	CN1-27	CN1-28	The /BK signal is output from CN1-27 and CN1-28.		

5.12.3 Output Timing of /BK (Brake) Signal When the Servomotor Is Stopped

- Axis B

Parameter	Connector Pin No.		Meaning	When Enabled	Classification	
	+ Pin	- Pin				
Pn50F	n.□0□□	-	-	The /BK signal is not used.	After restart	Setup
	n.□1□□ (default setting)	CN1-25	CN1-26	The /BK signal is output from CN1-25 and CN1-26.		
	n.□2□□	CN1-29	CN1-30	The /BK signal is output from CN1-29 and CN1-30.		



**Important** If you allocate more than one signal to the same output connector pin, a logical OR of the signals is output. Allocate the /BK signal to its own output connector pin, i.e., do not use the same output terminal for another signal.  
For example, never allocate the /TGON (Rotation Detection) signal and /BK signal to the same output connector pin. If you did so, the /TGON signal would be turned ON by the falling speed on a vertical axis, and the brake would not operate.

## 5.12.3 Output Timing of /BK (Brake) Signal When the Servomotor Is Stopped

When the Servomotor is stopped, the /BK signal turns OFF as soon as the SV\_OFF (Servo OFF) command is received. Use the servo OFF delay time (Pn506) to change the timing to turn OFF power supply to the motor after the SV\_OFF command is input.

Pn506	Brake Reference-Servo OFF Delay Time			Speed	Position	Torque
	Setting Range	Setting Unit	Default Setting	When Enabled	Classification	
	0 to 50	10 ms	0	Immediately	Setup	

- When the Servomotor is used to control a vertical axis, the machine moving part may move slightly due to gravity or an external force. You can eliminate this slight motion by setting the servo OFF delay time (Pn506) so that power supply to the motor is stopped after the brake is applied.
- This parameter sets the timing of stopping power supply to the Servomotor while the Servomotor is stopped.

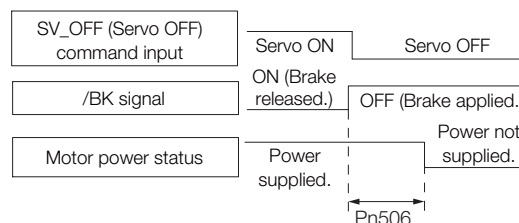



**Important** Power supply to the Servomotor will be stopped immediately when an alarm occurs, regardless of the setting of this parameter. The machine moving part may move due to gravity or an external force before the brake is applied.

## 5.12.4 Output Timing of /BK (Brake) Signal When the Servomotor Is Operating

If an alarm occurs while the Servomotor is operating, the Servomotor will start stopping and the /BK signal will be turned OFF. You can adjust the timing of /BK signal output by setting the brake reference output speed level (Rotary Servomotors: Pn507, Linear Servomotors: Pn583) and the servo OFF-brake reference waiting time (Pn508).

Note: If zero-speed stopping is set as the stopping method for alarms, the setting of Pn506 (Brake Reference-Servo OFF Delay Time) is used after the motor stops.

- Rotary Servomotors

Pn507	Brake Reference Output Speed Level			Speed	Position	Torque
	Setting Range	Setting Unit	Default Setting	When Enabled	Classification	
	0 to 10,000	1 min <sup>-1</sup>	100	Immediately	Setup	
Pn508	Servo OFF-Brake Reference Waiting Time			Speed	Position	Torque
	Setting Range	Setting Unit	Default Setting	When Enabled	Classification	
	10 to 100	10 ms	50	Immediately	Setup	

- Linear Servomotors

Pn583	Brake Reference Output Speed Level			Speed	Position	Force
	Setting Range	Setting Unit	Default Setting	When Enabled	Classification	
	0 to 10,000	1 mm/s	10	Immediately	Setup	
Pn508	Servo OFF-Brake Reference Waiting Time			Speed	Position	Force
	Setting Range	Setting Unit	Default Setting	When Enabled	Classification	
	10 to 100	10 ms	50	Immediately	Setup	

The brake operates when either of the following conditions is satisfied:

- When the Motor Speed Goes below the Level Set in Pn507 for a Rotary Servomotor or in Pn583 for a Linear Servomotor after the Power Supply to the Motor Is Stopped

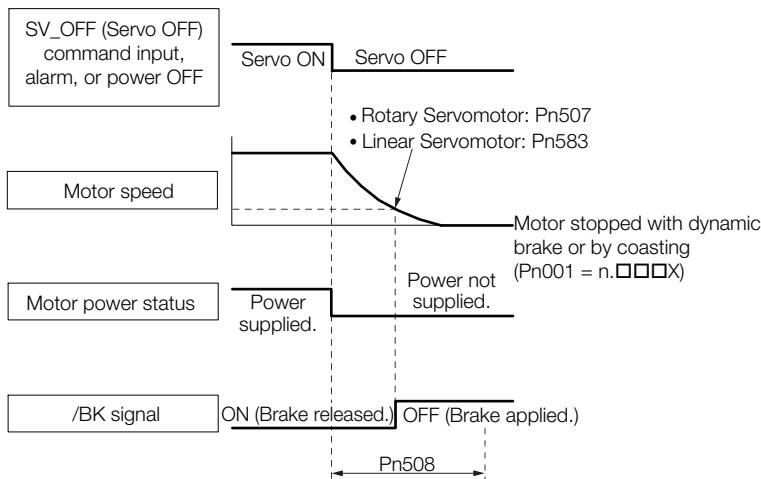

5.12.4 Output Timing of /BK (Brake) Signal When the Servomotor Is Operating

- When the Time Set In Pn508 Elapses after the Power Supply to the Motor Is Stopped

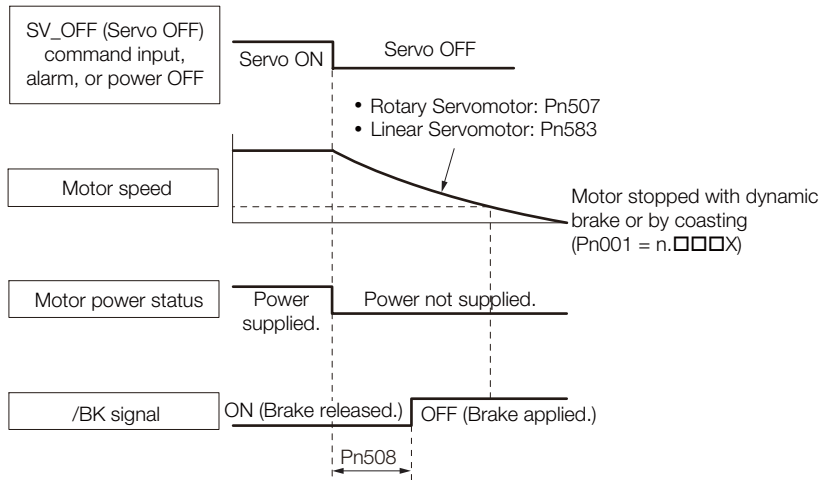

 **Important** The Servomotor will be limited to its maximum speed even if the brake reference output speed level (Rotary Servomotor: Pn507, Linear Servomotor: Pn583) is higher than the maximum speed.

## 5.13 Motor Stopping Methods for Servo OFF and Alarms

You can use the following methods to stop the Servomotor when the servo is turned OFF or an alarm occurs.

There are the following four stopping methods.

Motor Stopping Method	Meaning
Stopping by Applying the Dynamic Brake	The electric circuits are internally connected to stop the Servomotor quickly.
Coasting to a Stop	The motor stops naturally due to friction during operation.
Zero-speed Stopping	The speed reference is set to 0 to stop the Servomotor quickly.
Decelerating to a Stop	Emergency stop torque is used to decelerate the motor to a stop.

There are the following three conditions after stopping.

Status after Stopping	Meaning
Dynamic Brake Applied	The electric circuits are internally connected to hold the Servomotor.
Coasting	The SERVOPACK does not control the Servomotor. (The machine will move in response to a force from the load.)
Zero Clamping	A position loop is created and the Servomotor remains stopped at a position reference of 0. (The current stop position is held.)



- The dynamic brake is used for emergency stops. The dynamic brake circuit will operate frequently if the power supply is turned ON and OFF or the servo is turned ON and OFF while a reference input is applied to start and stop the Servomotor. This may result in deterioration of the internal elements in the SERVOPACK. Use speed input references or position references to start and stop the Servomotor.
- If you turn OFF the main circuit power supply or control power supply during operation before you turn OFF the servo, the Servomotor will stop with the dynamic brake. You cannot change this by setting a parameter.
- If the Servomotor must be stopped by coasting rather than with the dynamic brake when the main circuit power supply or the control power supply is turned OFF before the servo is turned OFF, use a SERVOPACK with the dynamic brake option.
- To minimize the coasting distance of the Servomotor to come to a stop when an alarm occurs, zero-speed stopping is the default method for alarms to which it is applicable. However, depending on the application, stopping with the dynamic brake may be more suitable than zero-speed stopping.  
For example, when coupling two shafts (twin-drive operation), machine damage may occur if a zero-speed stopping alarm occurs for one of the coupled shafts and the other shaft stops with a dynamic brake. In such cases, change the stopping method to the dynamic brake.

### 5.13.1 Stopping Method for Servo OFF

Set the stopping method for when the servo is turned OFF in Pn001 = n.□□□X (Servo OFF or Alarm Group 1 Stopping Method).

Parameter	Servomotor Stopping Method	Status after Servomotor Stops	When Enabled	Classification
Pn001	n.□□□0 (default setting)	Dynamic brake	After restart	Setup
	n.□□□1			
	n.□□□2	Coasting		

Note: If Pn001 is set to n.□□□0 (Stop the motor by applying the dynamic brake) and the Servomotor is stopped or operates at a low speed, braking force may not be generated, just like it is not generated for coasting to a stop.

## 5.13.2 Servomotor Stopping Method for Alarms

There are two types of alarms, group 1 (Gr. 1) alarms and group 2 (Gr. 2) alarms. A different parameter is used to set the stopping method for alarms for each alarm type.

Refer to the following section to see which alarms are in group 1 and which are in group 2.

 10.2.1 List of Alarms on page 10-5

### Motor Stopping Method for Group 1 Alarms

When a group 1 alarm occurs, the Servomotor will stop according to the setting of Pn001 = n.□□□X. The default setting is to stop by applying the dynamic brake.

Refer to the following section for details.

 5.13.1 Stopping Method for Servo OFF on page 5-38

### Motor Stopping Method for Group 2 Alarms

When a group 2 alarm occurs, the Servomotor will stop according to the settings of the following three parameters. The default setting is for zero clamping.

- Pn001 = n.□□□X (Servo OFF or Alarm Group 1 Stopping Method)
- Pn00A = n.□□□X (Motor Stopping Method for Group 2 Alarms)
- Pn00B = n.□□X□ (Motor Stopping Method for Group 2 Alarms)

However, during torque control, the group 1 stopping method is always used.



If you set Pn00B to n.□□1□ (Apply dynamic brake or coast Servomotor to a stop), you can use the same stopping method as group 1. If you are coordinating a number of Servomotors, you can use this stopping method to prevent machine damage that may result because of differences in the stopping method.

The following table shows the combinations of the parameter settings and the resulting stopping methods.

5.13 Motor Stopping Methods for Servo OFF and Alarms

5.13.2 Servomotor Stopping Method for Alarms

Parameter			Servomotor Stopping Method	Status after Servomotor Stops	When Enabled	Classification
Pn00B	Pn00A	Pn001				
n.□□0□ (default setting)	-	n.□□□0 (default setting)	Zero-speed stop- ping	Dynamic brake	After restart	Setup
		n.□□□1		Coasting		
		n.□□□2		Coasting		
n.□□1□	-	n.□□□0 (default setting)	Dynamic brake	Dynamic brake		
		n.□□□1		Coasting		
		n.□□□2	Coasting			
n.□□2□	n.□□□0	n.□□□0 (default setting)	Dynamic brake	Dynamic brake		
		n.□□□1		Coasting		
		n.□□□2	Coasting			
	n.□□□1 (default setting)	n.□□□2	n.□□□0 (default setting)	Motor is deceler- ated using the torque set in Pn406 as the maximum torque.		
			n.□□□1		Coasting	
			n.□□□2		Coasting	
	n.□□□2	n.□□□0 (default setting)	Coasting			
		n.□□□1				
		n.□□□2				
	n.□□□3	n.□□□4	n.□□□0 (default setting)	Motor is deceler- ated according to setting of Pn30A.	Dynamic brake	
			n.□□□1		Coasting	
			n.□□□2		Coasting	
n.□□□4	n.□□□0 (default setting)	Coasting				
	n.□□□1					
	n.□□□2					

- Note: 1. The setting of Pn00A is ignored if Pn00B is set to n.□□0□ or n.□□1□.  
 2. The setting of Pn00A = n.□□□X is enabled for position control and speed control. During torque control, the setting of Pn00A = n.□□□X will be ignored and only the setting of Pn001 = n.□□□X will be used.  
 3. Refer to the following section for details on Pn406 (Emergency Stop Torque).  
 **Stopping the Servomotor by Setting Emergency Stop Torque on page 5-30**  
 4. Refer to the following section for details on Pn30A (Deceleration Time for Servo OFF and Forced Stops).  
 **Stopping the Servomotor by Setting the Deceleration Time on page 5-30**



## 5.14 Motor Overload Detection Level

The motor overload detection level is the threshold used to detect overload alarms and overload warnings when the Servomotor is subjected to a continuous load that exceeds the Servomotor ratings.

It is designed to prevent Servomotor overheating.

You can change the detection timing for A.910 warnings (Overload) and A.720 alarms (Continuous Overload). You cannot change the detection level for A.710 alarms (Instantaneous Overload).

### 5.14.1 Detection Timing for Overload Warnings (A.910)

With the default setting for overload warnings, an overload warning is detected in 20% of the time required to detect an overload alarm. You can change the time required to detect an overload warning by changing the setting of the overload warning level (Pn52B). You can increase safety by using overload warning detection as an overload protection function matched to the system.

The following graph shows an example of the detection of overload warnings when the overload warning level (Pn52B) is changed from 20% to 50%. An overload warning is detected in half of the time required to detect an overload alarm.

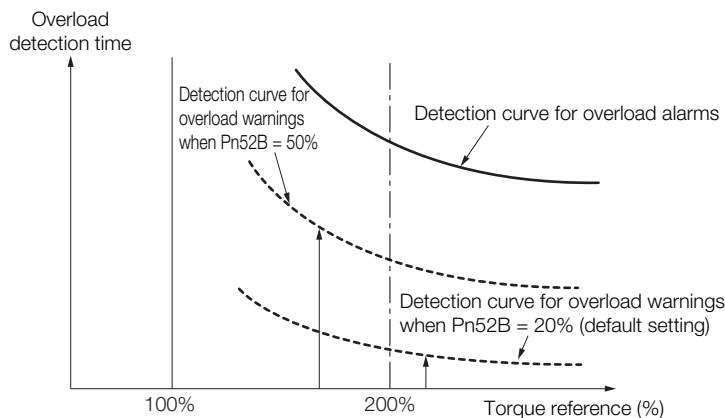

Pn52B	Overload Warning Level			Speed	Position	Torque
	Setting Range	Setting Unit	Default Setting	When Enabled	Classification	
	1 to 100	1%	20	Immediately	Setup	

## 5.14.2 Detection Timing for Overload Alarms (A.720)

If Servomotor heat dissipation is insufficient (e.g., if the heat sink is too small), you can lower the overload alarm detection level to help prevent overheating.

To reduce the overload alarm detection level, change the setting of Pn52C (Base Current Derating at Motor Overload Detection).

Pn52C	Base Current Derating at Motor Overload Detection			Speed	Position	Torque
	Setting Range	Setting Unit	Default Setting	When Enabled	Classification	
	10 to 100	1%	100	After restart	Setup	

An A.720 alarm (Continuous Overload) can be detected earlier to protect the Servomotor from overloading.

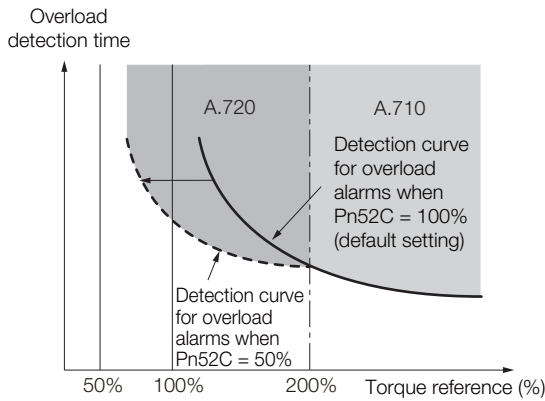

Note: The gray areas in the above graph show where A.710 and A.720 alarms occur.

Refer to the relevant manual given below for a diagram that shows the relationships between the Servomotor heat dissipation conditions (heat sink size, surrounding air temperature, and derating). You can protect the Servomotor from overloads more effectively by setting this derating value in Pn52C.

📖  $\Sigma$ -7-Series Rotary Servomotor Product Manual (Manual No.: SIEP S800001 36)

📖  $\Sigma$ -7-Series Linear Servomotor Product Manual (Manual No.: SIEP S800001 37)

📖  $\Sigma$ -7-Series Direct Drive Servomotor Product Manual (Manual No.: SIEP S800001 38)

## 5.15 Electronic Gear Settings

The minimum unit of the position data that is used to move a load is called the reference unit. The reference unit is used to give travel amounts, not in pulses, but rather in distances or other physical units (such as  $\mu\text{m}$  or  $^\circ$ ) that are easier to understand.

The electronic gear is used to convert the travel distances that are specified in reference units to pulses, which are required for actual movements.

With the electronic gear, one reference unit is equal to the workpiece travel distance per reference pulse input to the SERVOPACK. In other words, if you use the SERVOPACK's electronic gear, pulses can be read as reference units.

Note: If you set an electronic gear in the host controller, normally set the electronic gear ratio in the SERVOPACK to 1:1.

The difference between using and not using the electronic gear is shown below.

### • Rotary Servomotors

In this example, the following machine configuration is used to move the workpiece 10 mm.

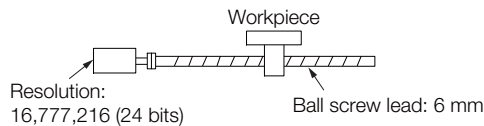

#### When the Electronic Gear Is Not Used

To move a workpiece 10 mm:  
 ① Calculate the number of revolutions.  
 The Servomotor will move 6 mm for each revolution, so  $10/6$  revolutions are required to move 10 mm.  
 ② Calculate the required number of reference pulses.  
 One revolution is 16,777,216 pulses, therefore  $10/6 \times 16,777,216 = 27,962,026.66$  pulses.  
 ③ Input 27,962,027 pulses as the reference.

Calculating the number of reference pulses for each reference is troublesome.

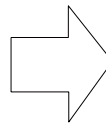

#### When the Electronic Gear Is Used

If you use reference units to move the workpiece when one reference unit is set to  $1 \mu\text{m}$ , the travel distance is  $1 \mu\text{m}$  per pulse.  
 To move the workpiece 10 mm ( $10,000 \mu\text{m}$ ),  $10,000 \div 1 = 10,000$  pulses, so 10,000 pulses would be input.

Calculating the number of reference pulses for each reference is not necessary.

### • Linear Servomotors

In this example, the following machine configuration is used to move the load 10 mm. We'll assume that the resolution of the Serial Converter Unit is 256 and that the linear encoder pitch is  $20 \mu\text{m}$ .

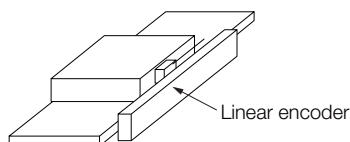

#### When the Electronic Gear Is Not Used

To move the load 10 mm:  
 $10 \times 1000 \div 20 \times 256 = 128,000$  pulses, so 128,000 pulses are input as the reference.

Calculating the number of reference pulses for each reference is troublesome.

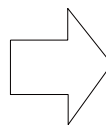

#### When the Electronic Gear Is Used

To use reference units to move the load 10 mm:  
 If we set the reference unit to  $1 \mu\text{m}$ , the travel distance is  $1 \mu\text{m}$  per pulse. To move the load 10 mm ( $10,000 \mu\text{m}$ ),  $10,000/1 = 10,000$  pulses, so 10,000 pulses would be input as the reference.

Calculating the number of reference pulses for each reference is not necessary.

## 5.15.1 Electronic Gear Ratio Settings

Set the electronic gear ratio using Pn20E and Pn210.



Important

Set the electronic gear ratio within the following range.  
 $0.001 \leq \text{Electronic gear ratio (B/A)} \leq 64,000$   
 If the electronic gear ratio is outside of this range, an A.040 alarm (Parameter Setting Error) will occur.

Pn20E	Electronic Gear Ratio (Numerator) <span style="float: right;">Position</span>				
	Setting Range	Setting Unit	Default Setting	When Enabled	Classification
	1 to 1,073,741,824	1	16	After restart	Setup
Pn210	Electronic Gear Ratio (Denominator) <span style="float: right;">Position</span>				
	Setting Range	Setting Unit	Default Setting	When Enabled	Classification
	1 to 1,073,741,824	1	1	After restart	Setup

### Calculating the Settings for the Electronic Gear Ratio

#### ◆ Rotary Servomotors

If the gear ratio between the Servomotor shaft and the load is given as n/m, where n is the number of load rotations for m Servomotor shaft rotations, the settings for the electronic gear ratio can be calculated as follows:

$$\text{Electronic gear ratio } \frac{B}{A} = \frac{\text{Pn20E}}{\text{Pn210}} = \frac{\text{Encoder resolution}}{\text{Travel distance per load shaft revolution (reference units)}} \times \frac{m}{n}$$

## Encoder Resolution

You can check the encoder resolution in the Servomotor model number.

Code	Specification	Encoder Resolution
3	20-bit multiturn absolute encoder	1,048,576

SGM7M - □□□□□□

Code	Specification	Encoder Resolution
6	24-bit batteryless multiturn absolute encoder	16,777,216
7	24-bit multiturn absolute encoder	16,777,216
F	24-bit incremental encoder	16,777,216

SGM7J, SGM7A,  
SGM7P, SGM7G - □□□□□□

Code	Specification	Encoder Resolution
7	24-bit multiturn absolute encoder	16,777,216
F	24-bit incremental encoder	16,777,216

SGM7E, SGM7F - □□□□□□

Code	Specification	Encoder Resolution
3	20-bit single-turn absolute encoder	1,048,576
D	20-bit incremental encoder	1,048,576

SGMCS - □□□□□□

Code	Specification	Encoder Resolution
E	22-bit single-turn absolute encoder	4,194,304
I	22-bit multiturn absolute encoder	4,194,304

SGMCM - □□□□□□

## Linear Servomotors

You can calculate the settings for the electronic gear ratio with the following equation:

When Not Using a Serial Converter Unit

Use the following formula if the linear encoder and SERVOPACK are connected directly or if a linear encoder that does not require a Serial Converter Unit is used.

$$\text{Electronic gear ratio } \frac{B}{A} = \frac{Pn20E}{Pn210} = \frac{\text{Travel distance per reference unit (reference units)} \times \text{Linear encoder resolution}}{\text{Linear encoder pitch (the value from the following table)}}$$

When Using a Serial Converter Unit

$$\text{Electronic gear ratio } \frac{B}{A} = \frac{Pn20E}{Pn210} = \frac{\text{Travel distance per reference unit (reference units)} \times \text{Resolution of the Serial Converter Unit}}{\text{Linear encoder pitch (setting of Pn282)}}$$

■ Feedback Resolution of Linear Encoder

The linear encoder pitches and resolutions are given in the following table.

Calculate the electronic gear ratio using the values in the following table.

Type of Linear Encoder	Manufacturer	Linear Encoder Model	Linear Encoder Pitch [μm] <sup>*1</sup>	Relay Device between SERVOPACK and Linear Encoder	Resolution	Resolution						
Incremental	Heidenhain Corporation	LIDA48□	20	JZDP-H003-□□□-E <sup>*2</sup>	256	0.078 μm						
				JZDP-J003-□□□-E <sup>*2</sup>	4,096	0.0049 μm						
		LIF48□	4	JZDP-H003-□□□-E <sup>*2</sup>	256	0.016 μm						
				JZDP-J003-□□□-E <sup>*2</sup>	4,096	0.00098 μm						
	Renishaw PLC	RGH22B	20	JZDP-H005-□□□-E <sup>*2</sup>	256	0.078 μm						
				JZDP-J005-□□□-E <sup>*2</sup>	4,096	0.0049 μm						
	Magnescale Co., Ltd.	SR75-□□□□□LF	80	-	-	8,192	0.0098 μm					
						1,024	0.078 μm					
						SR85-□□□□□LF	80	-	-	8,192	0.0098 μm	
										1,024	0.078 μm	
		SL700, SL710, SL720, SL730	800	-	-	PL101-RY <sup>*3</sup>	8,192	0.0977 μm				
						MJ620-T13 <sup>*4</sup>						
	SQ10	400	-	-	MQ10-FLA <sup>*4</sup>	8,192	0.0488 μm					
					MQ10-GLA <sup>*4</sup>							
Absolute	Heidenhain Corporation	LIC4100 Series	20.48	EIB3391Y <sup>*4</sup>	4,096	0.005 μm						
		LIC2100 Series	204.8	EIB3391Y <sup>*4</sup>	4096	0.05 μm						
			409.6	EIB3391Y <sup>*4</sup>	4096	0.1 μm						
		LC115	40.96	EIB3381Y <sup>*4</sup>	4,096	0.01 μm						
		LC415	40.96	EIB3391Y <sup>*4</sup>	4096	0.01 μm						
	Mitutoyo Corporation	ST781A/ST781AL	256	-	-	512	0.5 μm					
		ST782A/ST782AL	256	-	-	512	0.5 μm					
		ST783/ST783AL	51.2	-	-	512	0.1 μm					
		ST784/ST784AL	51.2	-	-	512	0.1 μm					
		ST788A/ST788AL	51.2	-	-	512	0.1 μm					
		ST789A/ST789AL	25.6	-	-	512	0.05 μm					
		ST1381	5.12	-	-	512	0.01 μm					
		ST1382	0.512	-	-	512	0.001 μm					
	Renishaw PLC	EL36Y-□□050F□□□	12.8	-	-	256	0.05 μm					
		EL36Y-□□100F□□□	25.6	-	-	256	0.1 μm					
		EL36Y-□□500F□□□	128	-	-	256	0.5 μm					
		RL36Y-□□050□□□□	12.8	-	-	256	0.05 μm					
		RL36Y-□□001□□□□	0.256	-	-	256	0.001 μm					
	Magnescale Co., Ltd.	SR77-□□□□□LF	80	-	-	8,192	0.0098 μm					
						1,024	0.078 μm					
						SR87-□□□□□LF	80	-	-	8,192	0.0098 μm	
										1,024	0.078 μm	
		SQ47/SQ57-□□□□S□F□□□	20.48	-	-	-	4096	0.005 μm				
							SQ47/SQ57-□□□□T□F□□□	40.96	-	-	-	4096
SQ47/SQ57-□□□□A□F□□□												
SQ47/SQ57-□□□□F□F□□□												

\*1. These are reference values for setting SERVOPACK parameters. Contact the manufacturer for actual linear encoder scale pitches.

- \*2. This is the model of the Serial Converter Unit.
- \*3. This is the model of the Head with Interpolator.
- \*4. This is the model of the Interpolator.

**Information**

**Resolution**

You can calculate the resolution that is used inside the SERVOPACK (i.e., the travel distance per feedback pulse) with the following formula.

$$\text{Resolution (travel distance per feedback pulse)} = \frac{\text{Linear encoder pitch}}{\text{Resolution of Serial Converter Unit or linear encoder}}$$

The SERVOPACK uses feedback pulses as the unit to control a Servomotor.

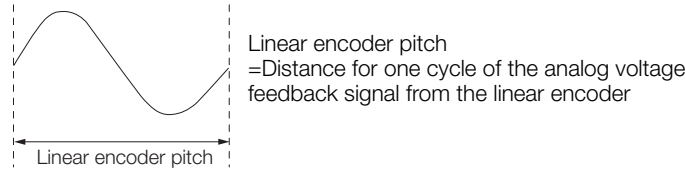

## 5.15.2 Electronic Gear Ratio Setting Examples

Setting examples are provided in this section.

- Rotary Servomotors

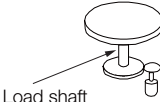
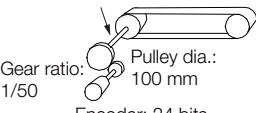
Step	Description	Machine Configuration		
		Ball Screw	Rotary Table	Belt and Pulley
		Reference unit: 0.001 mm Load shaft  Encoder: 24 bits    Ball screw lead: 6 mm	Reference unit: 0.01°  Gear ratio: 1/100 Encoder: 24 bits	Reference unit: 0.005 mm Load shaft  Gear ratio: 1/50    Pulley dia.: 100 mm Encoder: 24 bits
1	Machine Specifications	<ul style="list-style-type: none"> <li>• Ball screw lead: 6 mm</li> <li>• Gear ratio: 1/1</li> </ul>	<ul style="list-style-type: none"> <li>• Rotation angle per revolution: 360°</li> <li>• Gear ratio: 1/100</li> </ul>	<ul style="list-style-type: none"> <li>• Pulley dia.: 100 mm (Pulley circumference: 314 mm)</li> <li>• Gear ratio: 1/50</li> </ul>
2	Encoder Resolution	16,777,216 (24 bits)	16,777,216 (24 bits)	16,777,216 (24 bits)
3	Reference Unit	0.001 mm (1 μm)	0.01°	0.005 mm (5 μm)
4	Travel Distance per Load Shaft Revolution (Reference Units)	6 mm/0.001 mm = 6,000	360°/0.01° = 36,000	314 mm/0.005 mm = 62,800
5	Electronic Gear Ratio	$\frac{B}{A} = \frac{16,777,216}{6,000} \times \frac{1}{1}$	$\frac{B}{A} = \frac{16,777,216}{36,000} \times \frac{100}{1}$	$\frac{B}{A} = \frac{16,777,216}{62,800} \times \frac{50}{1}$
6	Parameters	Pn20E: 16,777,216	Pn20E: 167,772,160	Pn20E: 838,860,800
		Pn210: 6,000	Pn210: 3,600	Pn210: 62,800

- Linear Servomotors

A setting example for a Serial Converter Unit resolution of 256 is given below.

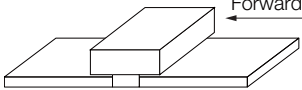
Step	Description	Machine Configuration
		Reference unit: 0.02 mm (20 μm)  Forward direction
1	Linear encoder pitch	0.02 mm (20 μm)
2	Reference Unit	0.001 mm (1 μm)
3	Electronic Gear Ratio	$\frac{B}{A} = \frac{1 (\mu\text{m})}{20 (\mu\text{m})} \times 256$
4	Setting Parameters	Pn20E: 256
		Pn210: 20

## 5.16 Resetting the Absolute Encoder

In a system that uses an absolute encoder, the multiturn data must be reset at startup. An alarm related to the absolute encoder (A.810 or A.820) will occur when the absolute encoder must be reset, such as when the power supply is turned ON.

When you reset the absolute encoder, the multiturn data is reset and any alarms related to the absolute encoder are cleared.

Reset the absolute encoder in the following cases.

- When an A.810 alarm (Encoder Backup Alarm) occurs
- When an A.820 alarm (Encoder Checksum Alarm) occurs
- When starting the system for the first time
- When you want to reset the multiturn data in the absolute encoder
- When the Servomotor has been replaced



### CAUTION

- The multiturn data will be reset to a value between -2 and +2 rotations when the absolute encoder is reset. The reference position of the machine system will change. Adjust the reference position in the host controller to the position that results from resetting the absolute encoder.

If the machine is started without adjusting the position in the host controller, unexpected operation may cause personal injury or damage to the machine.

#### Information

1. The multiturn data will always be zero in the following cases. It is never necessary to reset the absolute encoder in these cases. An alarm related to the absolute encoder (A.810 or A.820) will not occur.
  - When you use a single-turn absolute encoder
  - When the encoder is set to be used as a single-turn absolute encoder (Pn002 = n.□2□□)
2. If a batteryless absolute encoder is used, an A.810 alarm (Encoder Backup Alarm) will occur the first time the power is turned ON. After you reset the absolute encoder, the A.810 alarm will no longer occur.

### 5.16.1 Precautions on Resetting

- You cannot use the ALM\_CLR (Clear Alarm) command from the SERVOPACK to clear the A.810 alarm (Encoder Backup Alarm) or the A.820 alarm (Encoder Checksum Alarm). Always use the operation to reset the absolute encoder to clear these alarms.
- If an A.8□□ alarm (Internal Encoder Monitoring Alarm) occurs, turn OFF the power supply to reset the alarm.

### 5.16.2 Preparations



Always check the following before you reset an absolute encoder.

- The parameters must not be write prohibited.
- The servo must be OFF for both axis A and axis B.



## 5.16.3 Applicable Tools

The following table lists the tools that you can use to reset the absolute encoder and the applicable tool functions.

Tool	Function	Reference
Digital Operator	Fn008	 $\Sigma$ -7-Series Digital Operator Operating Manual (Manual No.: SIEP S800001 33)
SigmaWin+	<b>Setup - Absolute Encoder Reset</b>	 5.16.4 Operating Procedure on page 5-49

### Information

You can reset the absolute encoder using the MEM\_WR (Write Memory) command. Refer to the following manual for information on the MEM\_WR (Write Memory) command.

  $\Sigma$ -7-Series MECHATROLINK-III Communications Standard Servo Profile Command Manual (Manual No.: SIEP S800001 31)

## 5.16.4 Operating Procedure

Use the following procedure to reset the absolute encoder.

1. Confirm that the servo is OFF.
2. Click the  Servo Drive Button in the workspace of the Main Window of the SigmaWin+.
3. Select **Absolute Encoder Reset** in the Menu Dialog Box.  
The Absolute Encoder Reset Dialog Box will be displayed.
4. Click the **Continue** Button.

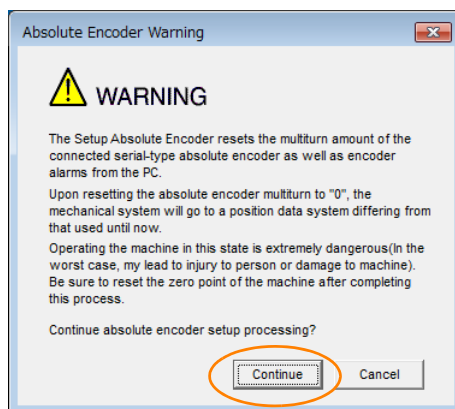

Click the **Cancel** Button to cancel resetting the absolute encoder. The Main Window will return.

5. Click the **Execute setting** Button.

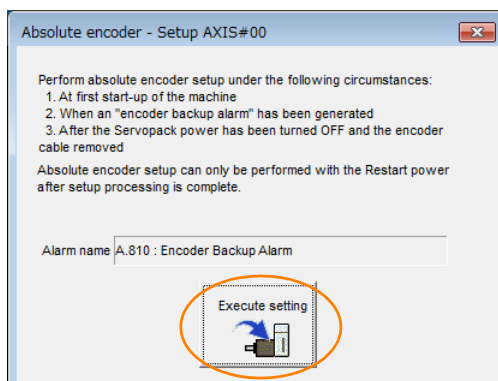

The current alarm code and name will be displayed in the **Alarm name** Box.

6. Click the **Continue** Button.

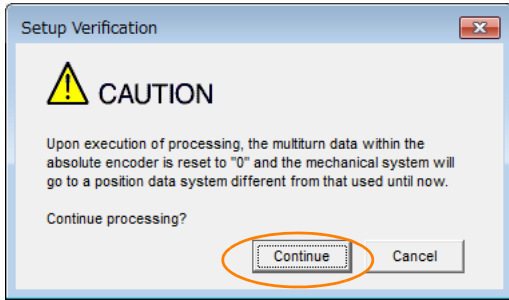

Click the **Cancel** Button to cancel resetting the absolute encoder. The previous dialog box will return.

7. Click the **OK** Button.

The absolute encoder will be reset.

When Resetting Fails

If you attempted to reset the absolute encoder when the servo was ON in the SERVOPACK, the following dialog box will be displayed and processing will be canceled.

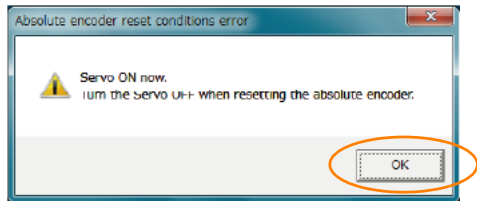

Click the **OK** Button. The Main Window will return. Turn OFF the servo and repeat the procedure from step 1.

When Resetting Is Successful

The following dialog box will be displayed when the absolute encoder has been reset.

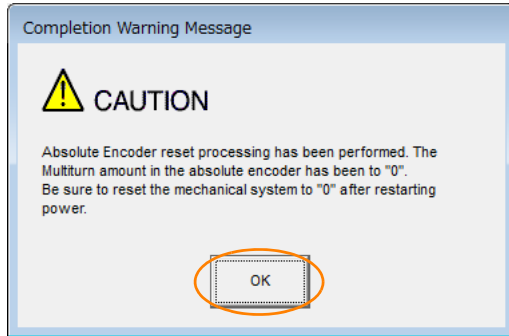

The Main Window will return.

8. To enable the change to the settings, turn the power supply to the SERVOPACK OFF and ON again.

This concludes the procedure to reset the absolute encoder.

## 5.17 Setting the Origin of the Absolute Encoder

### 5.17.1 Absolute Encoder Origin Offset

The origin offset of the absolute encoder is a correction that is used to set the origin of the machine coordinate system in addition to the origin of the absolute encoder. Set the offset between the absolute encoder origin and the machine coordinate system origin in Pn808 (Absolute Encoder Origin Offset).

After the SENS\_ON (Absolute Data Request) command is received, the position in the machine coordinate system (APOS) is set based on the absolute encoder position data and the setting of Pn808.

Pn808	Absolute Encoder Origin Offset				Position
	Setting Range	Setting Unit	Default Setting	When Enabled	Classification
	-1,073,741,823 to 1,073,741,823	1 reference unit	0	Immediately	Setup

**Example** If the encoder position (X) is at the origin of the machine coordinate system (0), then Pn808 would be set to -X.

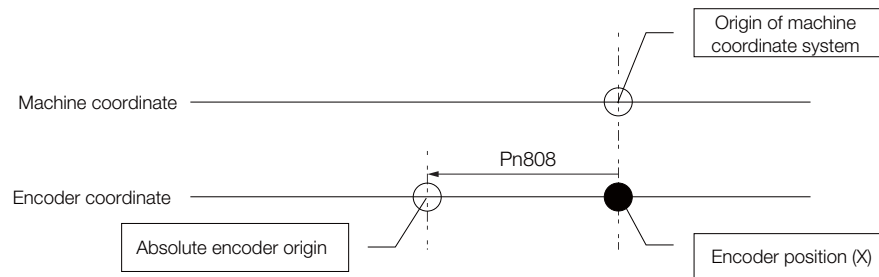

### 5.17.2 Setting the Origin of the Absolute Linear Encoder

You can set any position as the origin in the following Linear Encoders.

- Mitutoyo Corporation  
ABS ST780A Series or ST1300 Series  
Models: ABS ST78□A/ST78□AL/ST13□□
- Renishaw PLC  
EVOLUTE Series  
Models: EL36Y-□□□□□□□□□□
- Renishaw PLC  
RESOLUTE Series  
Models: RL36Y-□□□□□□□□□□



Important

1. After you set the origin, the /S-RDY (Servo Ready) signal will become inactive because the system position data was changed. Always turn the SERVOPACK power supply OFF and ON again.
2. After you set the origin, the Servomotor phase data in the SERVOPACK will be discarded. If you are using a Linear Servomotor without a Polarity Sensor, execute polarity detection again to save the Servomotor phase data in the SERVOPACK.



### Preparations

Always check the following before you set the origin of an absolute encoder.

- The parameters must not be write prohibited.
- The servo must be OFF.

## Applicable Tools

The following table lists the tools that you can use to set the origin of the absolute linear encoder and the applicable tool functions.

Tool	Function	Reference
Digital Operator	Fn020	 Σ-7-Series Digital Operator Operating Manual (Manual No.: SIEP S800001 33)
SigmaWin+	<b>Setup - Set Origin</b>	 Operating Procedure on page 5-52

## Operating Procedure

Use the following procedure to set the origin of an absolute linear encoder.

1. Click the  Servo Drive Button in the workspace of the Main Window of the SigmaWin+.
2. Select **Set Origin** in the Menu Dialog Box.  
The Set Origin Dialog Box will be displayed.
3. Click the **Continue** Button.



4. Click the **Execute** Button.

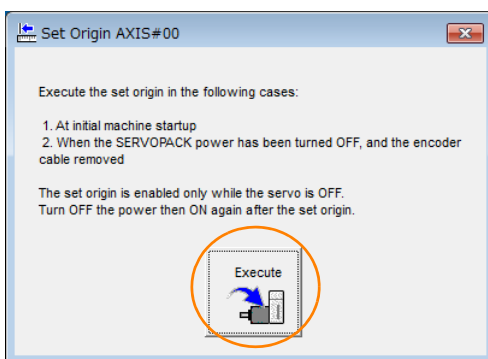

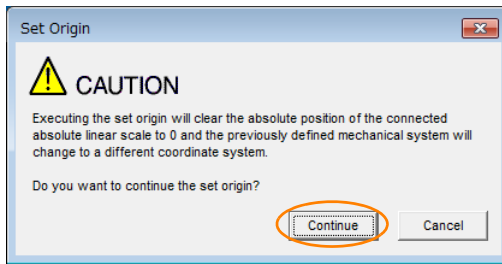
5. Click the **Continue** Button.

Click the **Cancel** Button to cancel setting the origin of the absolute linear encoder. The previous dialog box will return.

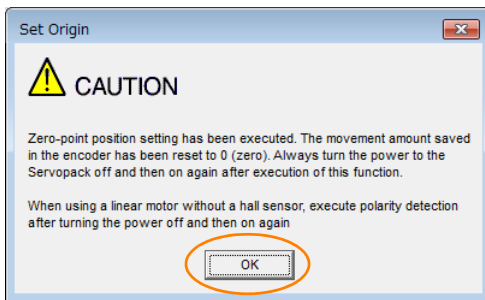
6. Click the **OK** Button.

## 7. Turn the power supply to the SERVOPACK OFF and ON again.

## 8. If you use a Linear Servomotor that does not have a polarity sensor, perform polarity detection.

Refer to the following section for details on the polarity detection.

 [5.10 Polarity Detection](#) on page 5-25

This concludes the procedure to set the origin of the absolute linear encoder.

# 5.18 Setting the Regenerative Resistor Capacity

The regenerative resistor consumes regenerative energy that is generated by the Servomotor, e.g., when the Servomotor decelerates.

If an External Regenerative Resistor is connected, you must set Pn600 (Regenerative Resistor Capacity) and Pn603 (Regenerative Resistor Resistance).

Refer to the following manual to select the capacity of a Regenerative Resistor.

📖  $\Sigma$ -7-Series Peripheral Device Selection Manual (Manual No.: SIEP S800001 32)

**WARNING**

- If you connect an External Regenerative Resistor, set Pn600 and Pn603 to suitable values. If a suitable value is not set, A.320 alarms (Regenerative Overload) will not be detected correctly, and the External Regenerative Resistor may be damaged or personal injury or fire may result.
- When you select an External Regenerative Resistor, make sure that it has a suitable capacity. There is a risk of personal injury or fire.

Pn600 <small>All Axes</small>	Regenerative Resistor Capacity <span style="float: right;"><small>Speed</small> <small>Position</small> <small>Torque</small></span>				
	Setting Range	Setting Unit	Default Setting	When Enabled	Classification
	0 to two times the SERVOPACK's maximum applicable motor capacity	10 W	0	Immediately	Setup
Pn603 <small>All Axes</small>	Regenerative Resistor Resistance <span style="float: right;"><small>Speed</small> <small>Position</small> <small>Torque</small></span>				
	Setting Range	Setting Unit	Default Setting	When Enabled	Classification
	0 to 65,535	10 m $\Omega$	0	Immediately	Setup

Set the regenerative resistor capacity to a value that is consistent with the allowable capacity of the External Regenerative Resistor. The setting depends on the cooling conditions of the External Regenerative Resistor.

- For self-cooling (natural convection cooling): Set the parameter to a maximum 20% of the capacity (W) of the actually installed regenerative resistor.
- For forced-air cooling: Set the parameter to a maximum 50% of the capacity (W) of the actually installed regenerative resistor.

**Example** For a self-cooling 100-W External Regenerative Resistor, set Pn600 to 2 ( $\times 10$  W) ( $100$  W  $\times$  20% = 20 W).

Note: 1. An A.320 alarm will be displayed if the setting is not suitable.  
 2. The default setting of 0 specifies that the SERVOPACK's built-in regenerative resistor or Yaskawa's Regenerative Resistor Unit is being used.

Important

1. When an External Regenerative Resistor is used at the normal rated load ratio, the resistor temperature increases to between 200°C and 300°C. Always apply derating. Consult the manufacturer for the resistor's load characteristics.
2. For safety, use an External Regenerative Resistor with a thermoswitch.

# Application Functions

# 6

This chapter describes the application functions that you can set before you start servo system operation. It also describes the setting methods.

<b>6.1</b>	<b>I/O Signal Allocations</b>	<b>6-3</b>
6.1.1	Input Signal Allocations	6-3
6.1.2	Output Signal Allocations	6-6
6.1.3	ALM (Servo Alarm) Signal	6-10
6.1.4	/WARN (Warning) Signal	6-10
6.1.5	/TGON (Rotation Detection) Signal	6-11
6.1.6	/S-RDY (Servo Ready) Signal	6-12
6.1.7	/V-CMP (Speed Coincidence Detection) Signal	6-12
6.1.8	/COIN (Positioning Completion) Signal	6-13
6.1.9	/NEAR (Near) Signal	6-14
6.1.10	Speed Limit during Torque Control	6-15
<b>6.2</b>	<b>Operation for Momentary Power Interruptions</b>	<b>6-17</b>
<b>6.3</b>	<b>SEMI F47 Function</b>	<b>6-18</b>
<b>6.4</b>	<b>Setting the Motor Maximum Speed</b>	<b>6-20</b>
<b>6.5</b>	<b>Software Limits</b>	<b>6-21</b>
6.5.1	Setting to Enable/Disable Software Limits	6-21
6.5.2	Setting the Software Limits	6-21
6.5.3	Software Limit Check for References	6-21
<b>6.6</b>	<b>Selecting Torque Limits</b>	<b>6-22</b>
6.6.1	Internal Torque Limits	6-22
6.6.2	External Torque Limits	6-23
6.6.3	/CLT (Torque Limit Detection) Signal	6-26

**6.7 Absolute Encoders . . . . . 6-27**

- 6.7.1 Connecting an Absolute Encoder . . . . . 6-28
- 6.7.2 Structure of the Position Data of the Absolute Encoder . . . . . 6-28
- 6.7.3 Reading the Position Data from the Absolute Encoder . . . . . 6-28
- 6.7.4 Multiturn Limit Setting . . . . . 6-28
- 6.7.5 Multiturn Limit Disagreement Alarm (A.CC0) . . . 6-30

**6.8 Absolute Linear Encoders . . . . . 6-33**

- 6.8.1 Connecting an Absolute Linear Encoder . . . . . 6-33
- 6.8.2 Structure of the Position Data of the Absolute Linear Encoder . . . . . 6-33
- 6.8.3 Reading the Position Data from the Absolute Linear Encoder . . . . . 6-33

**6.9 Software Reset . . . . . 6-34**

- 6.9.1 Preparations . . . . . 6-34
- 6.9.2 Applicable Tools . . . . . 6-34
- 6.9.3 Operating Procedure . . . . . 6-35

**6.10 Initializing the Vibration Detection Level . . 6-37**

- 6.10.1 Preparations . . . . . 6-37
- 6.10.2 Applicable Tools . . . . . 6-37
- 6.10.3 Operating Procedure . . . . . 6-38
- 6.10.4 Related Parameters . . . . . 6-39

**6.11 Adjusting the Motor Current Detection Signal Offset . . . . 6-41**

- 6.11.1 Automatic Adjustment . . . . . 6-41
- 6.11.2 Manual Adjustment . . . . . 6-43

**6.12 Forcing the Motor to Stop . . . . . 6-45**

- 6.12.1 FSTP (Forced Stop Input) Signal . . . . . 6-45
- 6.12.2 Stopping Method Selection for Forced Stops . . 6-46
- 6.12.3 Resetting Method for Forced Stops . . . . . 6-47

**6.13 Overheat Protection . . . . . 6-48**

- 6.13.1 Connecting the Overheat Protection Input (TH) Signal . . . . . 6-48
- 6.13.2 Overheat Protection Selection . . . . . 6-48



## 6.1 I/O Signal Allocations

Functions are allocated to the pins on the I/O signal connector (CN1) in advance. You can change the allocations and the polarity for some of the connector pins. Function allocations and polarity settings are made with parameters.

This section describes the I/O signal allocations.

There are the following two methods to allocate I/O signals.

Allocation Method	Description	Benefits
$\Sigma$ -7S-Compatible I/O Signal Allocations	Predetermined combinations of I/O signals, pin numbers, and polarities are provided and you can specify the required combination with a parameter.	Compatibility with $\Sigma$ -7S SERVOPACKs
Multi-Axis I/O Signal Allocations	You can specify the pin number to allocate for each I/O signal.	There are no restrictions in the combinations of I/O signals and pin numbers, allowing for flexible signal allocations.

Specify the allocation method to use in Pn50A = n.□□□X (I/O Signal Allocation Mode).

Parameter	Description	When Enabled	Classification
Pn50A	n.□□□1 (default setting)	After restart	Setup
	n.□□□2		

### 6.1.1 Input Signal Allocations



- If you change the default polarity settings for the P-OT (Forward Drive Prohibit) or N-OT (Reverse Drive Prohibit) signal, the overtravel function will not operate if there are signal line disconnections or other problems. If you must change the polarity of one of these signals, verify operation and make sure that no safety problems will exist.
- If you allocate two or more signals to the same input circuit, a logical OR of the inputs will be used and all of the allocated signals will operate accordingly. This may result in unexpected operation.

#### $\Sigma$ -7S-Compatible Input Signal Allocations

The input signals that you can allocate to the pins on the I/O signal connector (CN1) and the related parameters are given in the following table.

Input Signal	Input Signal Name	Parameter
P-OT	Forward Drive Prohibit	Pn50A = n.X□□□
N-OT	Reverse Drive Prohibit	Pn50B = n.□□□X
/P-CL	Forward External Torque Limit	Pn50B = n.□X□□
/N-CL	Reverse External Torque Limit	Pn50B = n.X□□□
/DEC	Origin Return Deceleration Switch Input	Pn511 = n.□□□X
/EXT1	External Latch Input 1	Pn511 = n.□□X□
/EXT2	External Latch Input 2	Pn511 = n.□X□□
/EXT3	External Latch Input 3	Pn511 = n.X□□□
FSTP	Forced Stop	Pn516 = n.□□□X

◆ Relationship between Parameter Settings, Allocated Pins, and Polarities

The following table shows the relationship between the input signal parameter settings, the pins on the I/O signal connector (CN1), and polarities.

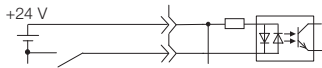
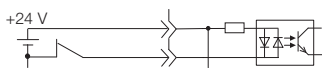
Parameter Setting	Pin No.		Description
	Axis A	Axis B	
0	3	9	 <p>A reverse signal (a signal with “/” before the signal abbreviation, such as the /P-CL signal) is active when the contacts are ON (closed). A signal that does not have “/” before the signal abbreviation (such as the P-OT signal) is active when the contacts are OFF (open).</p>
1	4	10	
2	5	11	
3	6	12	
4	7	13	
5	8	14	
6	–	–	Reserved parameter (Do not change.)
7	–	–	The input signal is not allocated to a connector pin and it is always active. If the signal is processed on a signal edge, then it is always inactive.
8	–	–	The input signal is not allocated to a connector pin and it is always inactive. Set the parameter to 8 if the signal is not used.
9	3	9	 <p>A reverse signal (a signal with “/” before the signal abbreviation, such as the /P-CL signal) is active when the contacts are OFF (open). A signal that does not have “/” before the signal abbreviation (such as the P-OT signal) is active when the contacts are ON (closed).</p>
A	4	10	
B	5	11	
C	6	12	
D	7	13	
F	–	–	

Note: 1. You cannot allocate the /EXT\_A1 to /EXT\_A3 and /EXT\_B1 to /EXT\_B3 (External Latch Inputs 1 to 3) signals to pins 6 to 8 and 12 to 14 on the I/O signal connector (CN1).

2. Refer to the following section for details on input signal parameter settings.

 11.1.2 List of Servo Parameters on page 11-3

◆ Example of Changing Input Signal Allocations

The following example shows reversing the P-OT (Forward Drive Prohibit) signal allocated to CN1-3 and CN1-9 and the /DEC (Origin Return Deceleration Switch) signal allocated to CN1-6 and CN1-12.

Pn50A = n.0□□1    Pn511 = n.□□□3    Before change  
                   ↓                                    ↓  
 Pn50A = n.3□□1    Pn511 = n.□□□0    After change

Refer to the following section for the parameter setting procedure.

 5.1.3 Parameter Setting Methods on page 5-5

Multi-Axis Input Signal Allocations

The input signals that you can allocate to the pins on the I/O signal connector (CN1) and the related parameters are given in the following table.

Input Signal	Input Signal Name	Parameter
P-OT	Forward Drive Prohibit Input Signal	Pn590
N-OT	Reverse Drive Prohibit Signal	Pn591
/DEC	Origin Return Deceleration Switch Signal	Pn592
/EXT1	External Latch Input 1 Signal	Pn593
/EXT2	External Latch Input 2 Signal	Pn594
/EXT3	External Latch Input 3 Signal	Pn595
/P-CL	Forward External Torque Limit Signal	Pn598
/N-CL	Reverse External Torque Limit Signal	Pn599

### ◆ Relationship between Parameter Settings, Allocated Pins, and Polarities

This section shows the relationship between the input signal parameter settings, the pins on the I/O signal connector (CN1), and the polarities using Pn592 (/DEC (Origin Return Deceleration Switch Input) Signal Allocation) as an example. Refer to the following section for information on individual input signals.

11.1.2 List of Servo Parameters on page 11-3

#### • Relationship between Parameter Settings and Pin Numbers

Parameter		Description	When Enabled	Classification
Pn592	n.□003 (default setting for axis A)	Allocate the signal to CN1-3.	After restart	Setup
	n.□004	Allocate the signal to CN1-4.		
	n.□005	Allocate the signal to CN1-5.		
	n.□006	Allocate the signal to CN1-6.		
	n.□007	Allocate the signal to CN1-7.		
	n.□008	Allocate the signal to CN1-8.		
	n.□009 (default setting for axis B)	Allocate the signal to CN1-9.		
	n.□010	Allocate the signal to CN1-10.		
	n.□011	Allocate the signal to CN1-11.		
	n.□012	Allocate the signal to CN1-12.		
	n.□013	Allocate the signal to CN1-13.		
	n.□014	Allocate the signal to CN1-14.		

#### • Relationship between Parameter Settings and Polarities

Parameter		Description	When Enabled	Classification
Pn592	n.0□□□ (default setting)	The signal is always inactive.	After restart	Setup
	n.1□□□	Active when input signal is ON (closed).		
	n.2□□□	Active when input signal is OFF (open).		
	n.3□□□	The signal is always active.		

## Confirming Input Signals

You can confirm the status of input signals on the I/O signal monitor. Refer to the following section for information on the I/O signal monitor.

9.2.3 I/O Signal Monitor on page 9-5

## 6.1.2 Output Signal Allocations

You can allocate the desired output signals to pins 23 to 32 on the I/O signal connector (CN1). The parameters that you use to allocate signals depend on whether you use  $\Sigma$ -7S-compatible I/O signal allocations (Pn50A = n.□□□1) or multi-axis I/O signal allocations (Pn50A = n.□□□2).

However, you can also force outputs on the servo command I/O signal (SVCMD\_IO) command.

Information is provided here for when signals are allocated with parameters.

Refer to the following section for details on forcing outputs with the SVCMD\_IO command.

 6.1.2 Output Signal Allocations - Forcing Outputs with MECHATROLINK-III Commands on page 6-8

### $\Sigma$ -7S-Compatible Output Signal Allocations

  
 Important

- The signals that are not detected are considered to be OFF. For example, the /COIN (Positioning Completion) signal is considered to be OFF during speed control.
- Reversing the polarity of the /BK (Brake) signal, i.e., changing it to positive logic, will prevent the holding brake from operating if its signal line is disconnected. If you must change the polarity of this signal, verify operation and make sure that no safety problems will exist.
- If you allocate more than one signal to the same output circuit, a logical OR of the signals will be output.

Output signals are allocated as shown in the following table.

Refer to *Interpreting the Output Signal Allocation Tables* and change the allocations accordingly.

Interpreting the Output Signal Allocation Tables

These columns give the parameter settings to use. Signals are allocated to CN1 pins according to the settings.

Output Signal Name and Parameter	Output Signals	CN1 Pin No.				Disabled (Not Used)
		Axis A: 23 and 24	Axis B: 25 and 26	Axis A: 27 and 28	Axis B: 29 and 30	
Brake Pn50F = □X□□	/BK	1		2		0

Output Signal Name and Parameter	Output Signals	CN1 Pin No.				Disabled (Not Used)
		Axis A: 23 and 24	Axis B: 25 and 26	Axis A: 27 and 28	Axis B: 29 and 30	
Positioning Completion Pn50E = n.□□□X	/COIN	1		2		0 (default setting)
Speed Coincidence Detection Pn50E = n.□□X□	/V-CMP	1		2		0 (default setting)
Rotation Detection Pn50E = n.□X□□	/TGON	1		2		0 (default setting)
Servo Ready Pn50E = n.X□□□	/S-RDY	1		2		0 (default setting)
Torque Limit Detection Pn50F = n.□□□X	/CLT	1		2		0 (default setting)
Speed Limit Detection Pn50F = n.□□X□	/MLT	1		2		0 (default setting)
Brake Pn50F = n.□X□□	/BK	1 (default setting)		2		0
Warning Pn50F = n.X□□□	/WARN	1		2		0 (default setting)
Near Pn510 = n.□□□X	NEAR	1		2		0 (default setting)
Preventative Maintenance Pn514 = n.□X□□	/PM	1		2		0 (default setting)
Pn512 = n.□□□1	Reverse polarity for CN1-23, CN1-24, CN1-25, and CN1-26					0 (default setting) The polarity is not reversed in the default settings.
Pn512 = n.□□1□	Reverse polarity for CN1-27, CN1-28, CN1-29, and CN1-30					

### ◆ Example of Changing Output Signal Allocations

The following example shows disabling the /COIN (Positioning Completion) signal allocated to CN1-27 and CN1-28 and allocating the /SRDY (Servo Ready) signal.

Pn50E = n.0□□2 Before change

↓

Pn50E = n.2□□0 After change

Refer to the following section for the parameter setting procedure.

 5.1.3 Parameter Setting Methods on page 5-5

## Multi-Axis Output Signal Allocations

The output signals that you can allocate to the pins on the I/O signal connector (CN1) and the related parameters are given in the following table.

Output Signal	Output Signal Name	Parameter
/COIN	Positioning Completion Output Signal	Pn5B0
/V-CMP	Speed Coincidence Detection Output Signal	Pn5B1
/TGON	Rotation Detection Output Signal	Pn5B2
/S-RDY	Servo Ready Output Signal	Pn5B3
/CLT	Torque Limit Detection Output Signal	Pn5B4
/MLT	Speed Limit Detection Output Signal	Pn5B5
/BK	Brake Output Signal	Pn5B6
/WARN	Warning Output Signal	Pn5B7
/NEAR	Near Output Signal	Pn5B8
/PM	Preventative Maintenance Output Signal	Pn5BC

### ◆ Relationship between Parameter Settings, Allocated Pins, and Polarities

This section shows the relationship between the output signal parameter settings, the pins on the I/O signal connector (CN1), and the polarities using Pn5B0 (/COIN (Positioning Completion Output) Signal Allocation) as an example. Refer to the following section for information on individual output signals.

 11.1.2 List of Servo Parameters on page 11-3

#### • Relationship between Parameter Settings and Pin Numbers

Parameter		Description	When Enabled	Classification
Pn5B0	n.□000 (default setting)	Disable (the signal output is not used).	After restart	Setup
	n.□023*	Allocate the signal to CN1-23.		
	n.□025*	Allocate the signal to CN1-25.		
	n.□027*	Allocate the signal to CN1-27.		
	n.□029*	Allocate the signal to CN1-29.		
n.□031*	Allocate the signal to CN1-31.			

\* If Pn5B0 is set to n.1□□□ (Output the signal) or n.2□□□ (Invert the signal and output it) and Pn5B0 is not set to any of these values, an A.040 alarm (Parameter Setting Error) will occur.

#### • Relationship between Parameter Settings and Polarities

Parameter		Description	When Enabled	Classification
Pn5B0	n.0□□□ (default setting)	Disable (the signal output is not used).	After restart	Setup
	n.1□□□	Output the signal.		
	n.2□□□	Invert the signal and output it.		

## Checking Output Signal Status

You can confirm the status of output signals on the I/O signal monitor. Refer to the following section for information on the I/O signal monitor.

 9.2.3 I/O Signal Monitor on page 9-5

## Forcing Outputs with MECHATROLINK-III Commands

You can use the servo command I/O signal (SVCMD\_IO) command through MECHATROLINK-III communications to force outputs on general-purpose sequence output 1 (SO1) to general-

purpose sequence output 5 (SO5).

Use Pn56A = n.XXXX to set the output signal reference method for SO1 to SO4. Use Pn56B = n.□□□X to set the output signal reference method for SO5.

Refer to the following manual for detailed information on the servo command I/O signal (SVCMD\_IO) command.

📖 Σ-7-Series MECHATROLINK-III Communications Standard Servo Profile Command Manual (Manual No.: SIEP S800001 31)

Parameter		Description	When Enabled	Classification
Pn56A	n.□□□0 (default setting)	Output parameter-assigned SO1 signal.	After restart	Setup
	n.□□□1	Output OR of parameter-assigned SO1 signal and signal set by SVCMD_IO.		
	n.□□□□ (default setting)	Output parameter-assigned SO2 signal.		
	n.□□1□	Output OR of parameter-assigned SO2 signal and signal set by SVCMD_IO.		
	n.□0□□ (default setting)	Output parameter-assigned SO3 signal.		
	n.□1□□	Output OR of parameter-assigned SO3 signal and signal set by SVCMD_IO.		
	n.0□□□ (default setting)	Output parameter-assigned SO4 signal.		
Pn56B	n.□□□0 (default setting)	Output parameter-assigned SO5 signal.	After restart	Setup
	n.□□□1	Output OR of parameter-assigned SO5 signal and signal set by SVCMD_IO.		

**Example** If you change the setting of Pn56A from the default setting to n.□□□1, an OR of the /BK signal and the signal that is set with the servo command I/O signal (SVCMD\_IO) command will be output.



**Important** To output only the signal that is set with the servo command I/O signal (SVCMD\_IO) command on SO1 to SO5, disable the signal that is allocated with the parameter (i.e., set it to not use the signal).

## 6.1.3 ALM (Servo Alarm) Signal

This signal is output when the SERVOPACK detects an error.



Configure an external circuit so that this alarm output turns OFF the main circuit power supply to the SERVOPACK whenever an error occurs.

Type	Signal	Connector Pin No.	Signal Status	Meaning
Output	ALM	Axis A: CN1-19 and CN1-20 Axis B: CN1-21 and CN1-22	ON (closed)	Normal SERVOPACK status
			OFF (open)	SERVOPACK alarm

### Alarm Reset Methods

Refer to the following section for information on the alarm reset methods.

10.2.3 Resetting Alarms on page 10-38

## 6.1.4 /WARN (Warning) Signal

Both alarms and warnings are generated by the SERVOPACK. Alarms indicate errors in the SERVOPACK for which operation must be stopped immediately. Warnings indicate situations that may result in alarms but for which stopping operation is not yet necessary.

The /WARN (Warning) signal indicates that a condition exists that may result in an alarm.

Type	Signal	Connector Pin No.	Signal Status	Meaning
Output	/WARN	Must be allocated.	ON (closed)	Warning
			OFF (open)	Normal status

Note: You must allocate the /WARN signal to use it. The parameters that you use depend on the allocation method.

Allocation Method	Parameter to Use
$\Sigma$ -7S-Compatible I/O Signal Allocations	<ul style="list-style-type: none"> <li>Pn50A = n.□□□1 (<math>\Sigma</math>-7S-Compatible I/O Signal Allocations)</li> <li>Pn50F = n.X□□□(/WARN (Warning Output) Signal Allocation)</li> </ul>
Multi-Axis I/O Signal Allocations	<ul style="list-style-type: none"> <li>Pn50A = n.□□□2 (Multi-Axis I/O Signal Allocations)</li> <li>Pn5B7 (/WARN (Warning Output) Signal Allocation)</li> </ul>

Refer to the following section for details.

6.1.2 Output Signal Allocations on page 6-6



## 6.1.5 /TGON (Rotation Detection) Signal

The /TGON signal indicates that the Servomotor is operating.

This signal is output when the shaft of the Servomotor rotates at the setting of Pn502 (Rotation Detection Level) or faster or the setting of Pn581 (Zero Speed Level) or faster.

Type	Signal	Connector Pin No.	Signal Status	Servomotor	Meaning
Output	/TGON	Must be allocated.	ON (closed)	Rotary Servomotors	The Servomotor is operating at the setting of Pn502 or faster.
				Linear Servomotors	The Servomotor is operating at the setting of Pn581 or faster.
			OFF (open)	Rotary Servomotors	The Servomotor is operating at a speed that is slower than the setting of Pn502.
				Linear Servomotors	The Servomotor is operating at a speed that is slower than the setting of Pn581.

Note: You must allocate the /TGON signal to use it. The parameters that you use depend on the allocation method.

Allocation Method	Parameter to Use
$\Sigma$ -7S-Compatible I/O Signal Allocations	<ul style="list-style-type: none"> <li>Pn50A = n.□□□1 (<math>\Sigma</math>-7S-Compatible I/O Signal Allocations)</li> <li>Pn50E = n.□X□□ (/TGON (Rotation Detection Output) Signal Allocation)</li> </ul>
Multi-Axis I/O Signal Allocations	<ul style="list-style-type: none"> <li>Pn50A = n.□□□2 (Multi-Axis I/O Signal Allocations)</li> <li>Pn5B2 (/TGON (Rotation Detection Output) Signal Allocation)</li> </ul>

Refer to the following section for details.

 [6.1.2 Output Signal Allocations](#) on page 6-6

## Setting the Rotation Detection Level

Use the following parameter to set the speed detection level at which to output the /TGON signal.

- Rotary Servomotors

Pn502	Rotation Detection Level			Speed	Position	Torque
	Setting Range	Setting Unit	Default Setting	When Enabled	Classification	
	1 to 10,000	1 min <sup>-1</sup>	20	Immediately	Setup	

- Linear Servomotors

Pn581	Zero Speed Level			Speed	Position	Force
	Setting Range	Setting Unit	Default Setting	When Enabled	Classification	
	1 to 10,000	1 mm/s	20	Immediately	Setup	

## 6.1.6 /S-RDY (Servo Ready) Signal

The /S-RDY (Servo Ready) signal turns ON when the SERVOPACK is ready to accept the SV\_ON (Servo ON) command.

The /S-RDY signal is turned ON under the following conditions.

- Main circuit power supply is ON.
- There are no alarms.
- If an absolute encoder is used, the SENS\_ON (Turn ON Sensor) command has been input.
- If a Servomotor without a polarity sensor is used, polarity detection has been completed. \*
- If an absolute encoder is used, the output of the position data from the absolute encoder to the host controller must have been completed if the SENS\_ON (Turn ON Sensor) command is being input.

\* Do not include this condition if the SV\_ON (Servo ON) command is input for the first time after the control power supply was turned ON. In that case, when the first SV\_ON command is input, polarity detection is started immediately and the /S-RDY signal turns ON at the completion of polarity detection.

Type	Signal	Connector Pin No.	Signal Status	Meaning
Output	/S-RDY	Must be allocated.	ON (closed)	Ready to receive the SV_ON (Servo ON) command.
			OFF (open)	Not ready to receive the SV_ON (Servo ON) command.

Note: You must allocate the /S-RDY signal to use it. The parameters that you use depend on the allocation method.

Allocation Method	Parameter to Use
Σ-7S-Compatible I/O Signal Allocations	<ul style="list-style-type: none"> <li>• Pn50A = n.□□□1 (Σ-7S-Compatible I/O Signal Allocations)</li> <li>• Pn50E = n.X□□□ (/S-RDY (Servo Ready) Signal Allocation)</li> </ul>
Multi-Axis I/O Signal Allocations	<ul style="list-style-type: none"> <li>• Pn50A = n.□□□2 (Multi-Axis I/O Signal Allocations)</li> <li>• Pn5B3 (/S-RDY (Servo Ready) Signal Allocation)</li> </ul>

Refer to the following section for details.

 6.1.2 Output Signal Allocations on page 6-6

## 6.1.7 /V-CMP (Speed Coincidence Detection) Signal

The /V-CMP (Speed Coincidence Output) signal is output when the Servomotor speed is the same as the reference speed. This signal is used, for example, to interlock the SERVOPACK and the host controller. You can use this output signal only during speed control.

The /V-CMP signal is described in the following table.

Type	Signal	Connector Pin No.	Signal Status	Meaning
Output	/V-CMP	Must be allocated.	ON (closed)	The speed coincides.
			OFF (open)	The speed does not coincide.

Note: You must allocate the /V-CMP signal to use it. The parameters that you use depend on the allocation method.

Allocation Method	Parameter to Use
Σ-7S-Compatible I/O Signal Allocations	<ul style="list-style-type: none"> <li>• Pn50A = n.□□□1 (Σ-7S-Compatible I/O Signal Allocations)</li> <li>• Pn50E = n.□□X□ (/V-CMP (Speed Coincidence Detection Output) Signal Allocation)</li> </ul>
Multi-Axis I/O Signal Allocations	<ul style="list-style-type: none"> <li>• Pn50A = n.□□□2 (Multi-Axis I/O Signal Allocations)</li> <li>• Pn5B1 (/V-CMP (Speed Coincidence Detection Output) Signal Allocation)</li> </ul>

Refer to the following section for details.

 6.1.2 Output Signal Allocations on page 6-6

You can set the speed detection width for the /V-CMP signal in Pn503 (Speed Coincidence Detection Signal Output Width) for a Rotary Servomotor or in Pn582 (Speed Coincidence Detection Signal Output Width) for a Linear Servomotor.

- Rotary Servomotors

Pn503	Speed Coincidence Detection Signal Output Width <span style="float: right;">[Speed]</span>				
	Setting Range	Setting Unit	Default Setting	When Enabled	Classification
	0 to 100	1 min <sup>-1</sup>	10	Immediately	Setup

The signal is output when the difference between the reference speed and motor speed is equal or less than the setting.

**Example** If Pn503 is set to 100 and the speed reference is 2,000 min<sup>-1</sup>, the signal would be output when the motor speed is between 1,900 min<sup>-1</sup> and 2,100 min<sup>-1</sup>.

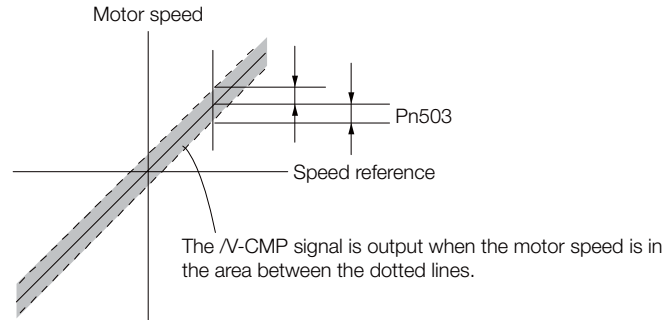

• Linear Servomotors

Pn582	Speed Coincidence Detection Signal Output Width				Speed
	Setting Range	Setting Unit	Default Setting	When Enabled	Classification
	0 to 100	1 mm/s	10	Immediately	Setup

The signal is output when the difference between the reference speed and motor speed is equal or less than the setting.

**Example** If Pn582 is set to 100 and the speed reference is 2,000 mm/s the signal would be output when the motor speed is between 1,900 mm/s and 2,100 mm/s.

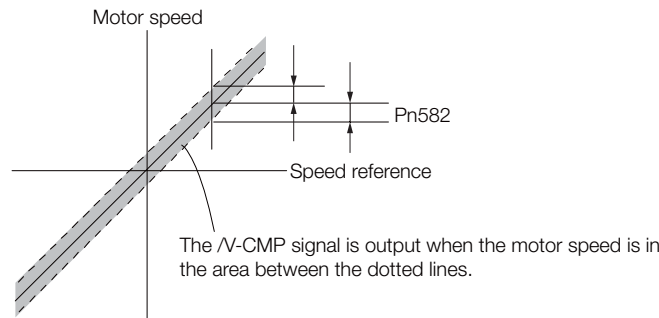

## 6.1.8 /COIN (Positioning Completion) Signal

The /COIN (Positioning Completion) signal indicates that Servomotor positioning has been completed during position control.

The /COIN signal is output when the difference between the reference position output by the host controller and the current position of the Servomotor (i.e., the position deviation as given by the value of the deviation counter) is equal to or less than the setting of the positioning completed width (Pn522).

Use this signal to check the completion of positioning from the host controller.

Type	Signal	Connector Pin No.	Signal Status	Meaning
Output	/COIN	Must be allocated.	ON (closed)	Positioning has been completed.
			OFF (open)	Positioning has not been completed.

Note: You must allocate the /COIN signal to use it. The parameters that you use depend on the allocation method.

Allocation Method	Parameter to Use
Σ-7S-Compatible I/O Signal Allocations	<ul style="list-style-type: none"> <li>Pn50A = n.□□□1 (Σ-7S-Compatible I/O Signal Allocations)</li> <li>Pn50E = n.□□□X (/COIN (Positioning Completion Output) Signal Allocation)</li> </ul>
Multi-Axis I/O Signal Allocations	<ul style="list-style-type: none"> <li>Pn50A = n.□□□2 (Multi-Axis I/O Signal Allocations)</li> <li>Pn5B0 (/COIN (Positioning Completion Output) Signal Allocation)</li> </ul>

Refer to the following section for details.

6.1.2 Output Signal Allocations on page 6-6

## Setting the Positioning Completed Width

The /COIN signal is output when the difference between the reference position and the current position (i.e., the position deviation as given by the value of the deviation counter) is equal to or less than the setting of the positioning completed width (Pn522).

Pn522	Positioning Completed Width				Position
	Setting Range	Setting Unit	Default Setting	When Enabled	Classification
	0 to 1,073,741,824	1 reference unit	7	Immediately	Setup

The setting of the positioning completed width has no effect on final positioning accuracy.

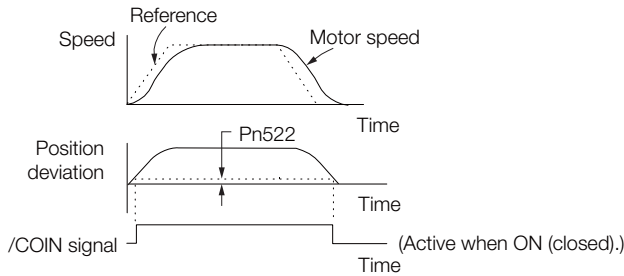

Note: If the parameter is set to a value that is too large, the /COIN signal may be output when the position deviation is low during a low-speed operation. If that occurs, reduce the setting until the signal is no longer output.

## Setting the Output Timing of the /COIN (Positioning Completion Output) Signal

You can add a reference input condition to the output conditions for the /COIN signal to change the signal output timing.

If the position deviation is always low and a narrow positioning completed width is used, change the setting of Pn207 = n.X□□□ (/COIN (Positioning Completion Output) Signal Output Timing) to change output timing for the /COIN signal.

Parameter	Description	When Enabled	Classification
Pn207	n.0□□□ (default setting)	After restart	Setup
	n.1□□□		
	n.2□□□		

## 6.1.9 /NEAR (Near) Signal

The /NEAR (Near) signal indicates when positioning completion is being approached.

The host controller receives the NEAR signal before it receives the /COIN (Positioning Completion) signal, it can start preparations for the operating sequence to use after positioning has been completed. This allows you to reduce the time required for operation when positioning is completed.

The NEAR signal is generally used in combination with the /COIN signal.

Type	Signal	Connector Pin No.	Signal Status	Meaning
Output	/NEAR	Must be allocated.	ON (closed)	The Servomotor has reached a point near to positioning completion.
			OFF (open)	The Servomotor has not reached a point near to positioning completion.

Note: You must allocate the /NEAR signal to use it. The parameters that you use depend on the allocation method.

Allocation Method	Parameter to Use
Σ-7S-Compatible I/O Signal Allocations	<ul style="list-style-type: none"> <li>• Pn50A = n.□□□1 (Σ-7S-Compatible I/O Signal Allocations)</li> <li>• Pn510 = n.□□□X (/NEAR (Near Output) Signal Allocation)</li> </ul>
Multi-Axis I/O Signal Allocations	<ul style="list-style-type: none"> <li>• Pn50A = n.□□□2 (Multi-Axis I/O Signal Allocations)</li> <li>• Pn5B8 (/NEAR (Near Output) Signal Allocation)</li> </ul>

Refer to the following section for details.

 6.1.2 Output Signal Allocations on page 6-6

## /NEAR (Near) Signal Setting

You set the condition for outputting the /NEAR (Near) signal (i.e., the near signal width) in Pn524 (Near Signal Width). The /NEAR signal is output when the difference between the reference position and the current position (i.e., the position deviation as given by the value of the deviation counter) is equal to or less than the setting of the near signal width (Pn524).

Pn524	Near Signal Width				Position
	Setting Range	Setting Unit	Default Setting	When Enabled	Classification
	1 to 1,073,741,824	1 reference unit	1,073,741,824	Immediately	Setup

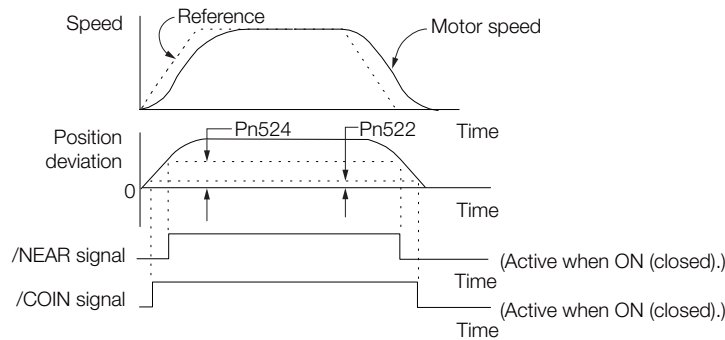

Note: Normally, set Pn524 to a value that is larger than the setting of Pn522 (Positioning Completed Width).

## 6.1.10 Speed Limit during Torque Control

You can limit the speed of the Servomotor to protect the machine.

When you use a Servomotor for torque control, the Servomotor is controlled to output the specified torque, but the motor speed is not controlled. Therefore, if a reference torque is input that is larger than the machine torque, the speed of the Servomotor may increase greatly. If that may occur, use this function to limit the speed.

Note: The actual limit of Servomotor speed depends on the load conditions on the Servomotor.

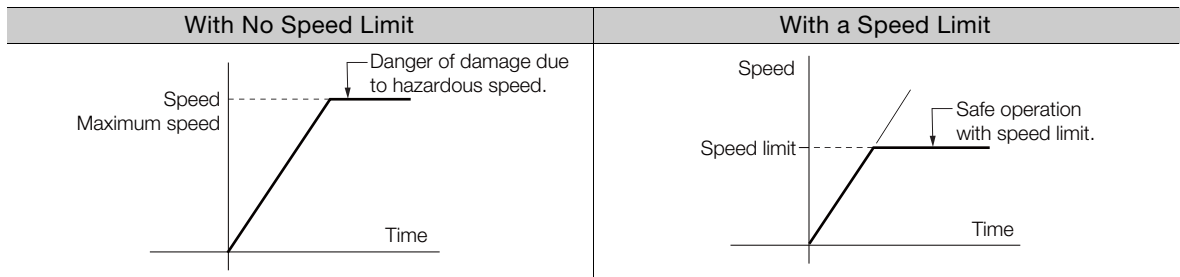

## /VLT (Speed Limit Detection) Signal

The signal that is output when the motor speed is being limited by the speed limit is described in the following table.

Type	Signal	Connector Pin No.	Signal Status	Meaning
Output	/VLT	Must be allocated.	ON (closed)	The Servomotor speed is being limited.
			OFF (open)	The Servomotor speed is not being limited.

Note: You must allocate the /VLT signal to use it. The parameters that you use depend on the allocation method.

Allocation Method	Parameter to Use
Σ-7S-Compatible I/O Signal Allocations	<ul style="list-style-type: none"> <li>Pn50A = n.□□□1 (Σ-7S-Compatible I/O Signal Allocations)</li> <li>Pn50F = n.□□X□ (/VLT (Speed Limit Detection) Signal Allocation)</li> </ul>
Multi-Axis I/O Signal Allocations	<ul style="list-style-type: none"> <li>Pn50A = n.□□□2 (Multi-Axis I/O Signal Allocations)</li> <li>Pn5B5 (/VLT (Speed Limit Detection) Signal Allocation)</li> </ul>

Refer to the following section for details.

6.1.2 Output Signal Allocations on page 6-6

## Selecting the Speed Limit

The smaller of the external speed limit and internal speed limit will be used.

Parameter	Meaning	When Enabled	Classification
Pn002	n.□□0□	After restart	Setup
	n.□□1□ (default setting)		
	Reserved setting (Do not use.)		
	Use the speed limit from the VLIM (Limit Speed for Torque Control) command as the speed limit. (Use external speed limiting.)		

### ◆ Internal Speed Limiting

Set the speed limit for the motor in Pn407 (Speed Limit during Torque Control) or Pn480 (Speed Limit during Force Control).

Also set Pn408 = n.□□X□ (Speed Limit Selection) to specify using the maximum motor speed or the overspeed alarm detection speed as the speed limit. Select the overspeed alarm detection speed to limit the speed to the equivalent of the maximum motor speed.

Parameter	Meaning	When Enabled	Classification
Pn408	n.□□0□ (default setting)	After restart	Setup
	n.□□1□		
	Use the smaller of the maximum motor speed and the setting of Pn407 or Pn480 as the speed limit.		
	Use the smaller of the overspeed alarm detection speed and the setting of Pn407 or Pn480 as the speed limit.		

Note: If you are using a Rotary Servomotor, set Pn407 (Speed Limit during Torque Control). If you are using a Linear Servomotor, set Pn480 (Speed Limit during Force Control).

#### • Rotary Servomotors

Pn407	Speed Limit during Torque Control <span style="float:right">Torque</span>				When Enabled	Classification
	Setting Range	Setting Unit	Default Setting			
	0 to 10,000	1 min <sup>-1</sup>	10000	Immediately		

#### • Linear Servomotors

Pn480	Speed Limit during Force Control <span style="float:right">Force</span>				When Enabled	Classification
	Setting Range	Setting Unit	Default Setting			
	0 to 10,000	1 mm/s	10000	Immediately		

Note: If the parameter setting exceeds the maximum speed of the Servomotor, the Servomotor's maximum speed or the overspeed alarm detection speed will be used.

### ◆ External Speed Limiting

The motor speed will be limited by VLIM (Limit Speed for Torque Control). Refer to the following manual for details.

Σ-7-Series MECHATROLINK-III Communications Standard Servo Profile Command Manual (Manual No.: SIEP S800001 31)

## 6.2

## Operation for Momentary Power Interruptions

Even if the main power supply to the SERVOPACK is interrupted momentarily, power supply to the motor (servo ON status) will be maintained for the time set in Pn509 (Momentary Power Interruption Hold Time).

Pn509 All Axes	Momentary Power Interruption Hold Time			Speed	Position	Torque
	Setting Range	Setting Unit	Default Setting	When Enabled	Classification	
	20 to 50,000	1 ms	20	Immediately	Setup	

If the momentary power interruption time is equal to or less than the setting of Pn509, power supply to the motor will be continued. If it is longer than the setting, power supply to the motor will be stopped. Power will be supplied to the motor again when the main circuit power supply recovers.

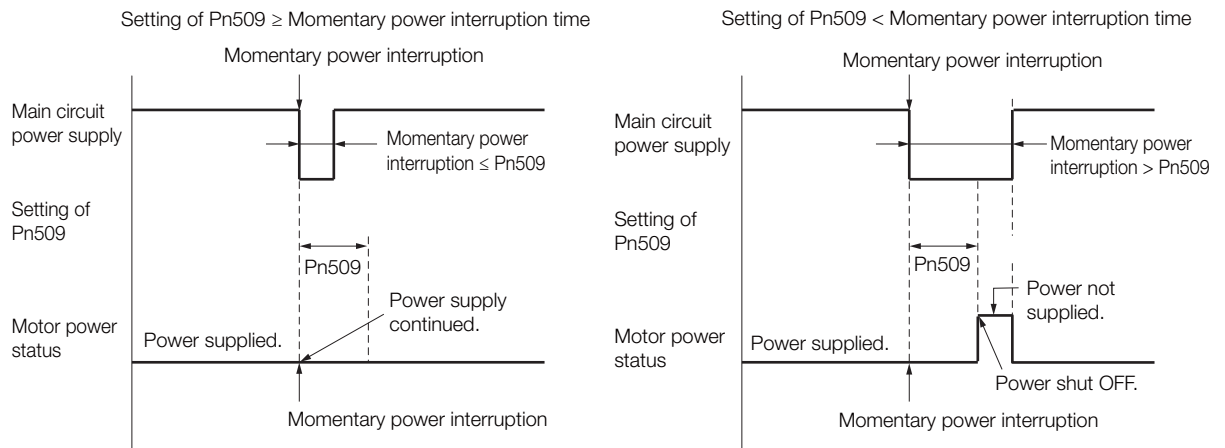

## Information

1. If the momentary power interruption time exceeds the setting of Pn509, the /S-RDY (Servo Ready) signal will turn OFF.
2. If uninterruptible power supplies are used for the control power supply and main circuit power supply, the SERVOPACK can withstand a power interruption that lasts longer than 50,000 ms.
3. The holding time of the SERVOPACK control power supply is approximately 100 ms. If control operations become impossible during a momentary power interruption of the control power supply, the setting of Pn509 will be ignored and the same operation will be performed as for when the power supply is turned OFF normally.



The holding time of the main circuit power supply depends on the output from the SERVOPACK. If the load on the Servomotor is large and an A.410 alarm (Undervoltage) occurs, the setting of Pn509 will be ignored.

# 6.3 SEMI F47 Function

The SEMI F47 function detects an A.971 warning (Undervoltage) and limits the output current if the DC main circuit power supply voltage to the SERVOPACK drops to a specified value or lower because the power was momentarily interrupted or the main circuit power supply voltage was temporarily reduced.

This function complies with the SEMI F47 standards for semiconductor manufacturing equipment.

You can combine this function with the momentary power interruption hold time (Pn509) to allow the Servomotor to continue operating without stopping for an alarm or without recovery work even if the power supply voltage drops.

## Execution Sequence

This function can be executed either with the host controller or with the SERVOPACK. Use Pn008 = n.□□X□ (Function Selection for Undervoltage) to specify whether the function is executed by the host controller or by the SERVOPACK.

The default setting (Pn008 = n.□□0□) disables detection of an A.971 warning (Undervoltage).

Parameter	Meaning	When Enabled	Classification
Pn008	n.□□0□ (default setting)		
	n.□□1□	After restart	Setup
	n.□□2□		

### ◆ Execution with the Host Controller (Pn008 = n.□□1□)

The host controller limits the torque in response to an A.971 warning (Undervoltage).

The host controller removes the torque limit after the Undervoltage warning is cleared.

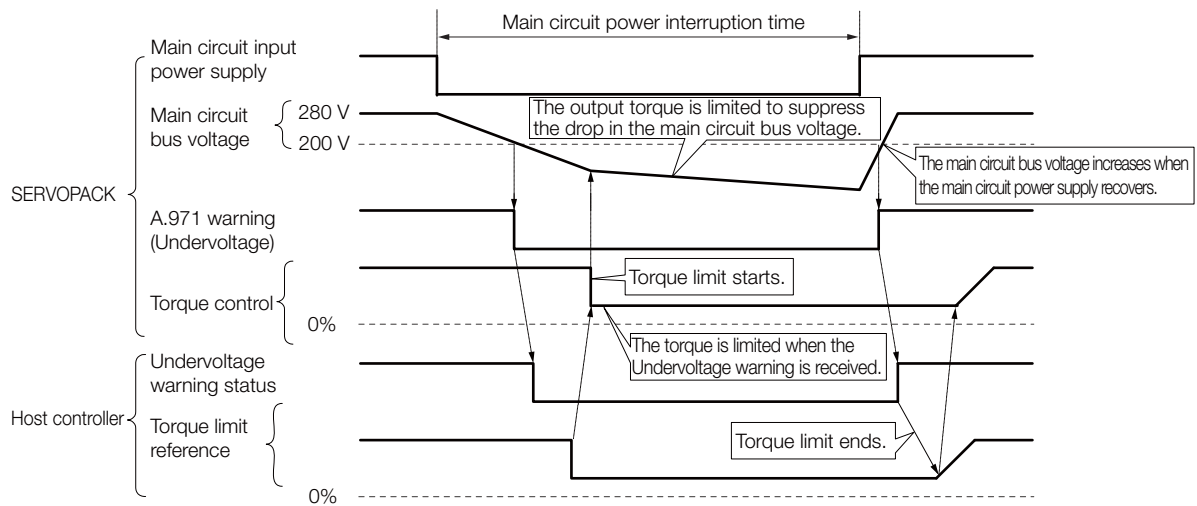



### ◆ Execution with the SERVOPACK (Pn008 = n.□□2□)

The torque is limited in the SERVOPACK in response to an Undervoltage warning. The SERVOPACK controls the torque limit for the set time after the Undervoltage warning is cleared.

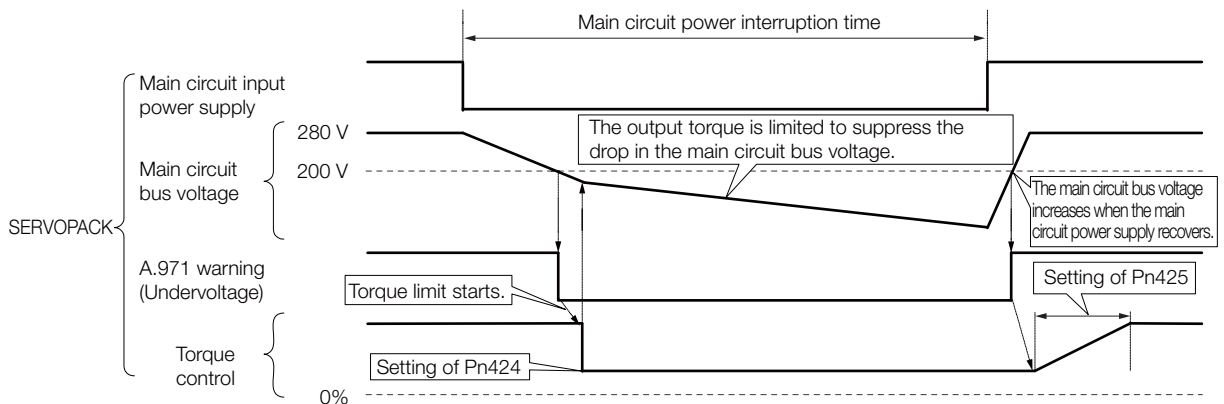

## Related Parameters

The following parameters are related to the SEMI F47 function.

Pn424	Torque Limit at Main Circuit Voltage Drop			<input type="checkbox"/> Speed	<input type="checkbox"/> Position	<input type="checkbox"/> Torque
	Setting Range	Setting Unit	Default Setting	When Enabled	Classification	
	0 to 100	1%*	50	Immediately	Setup	
Pn425	Release Time for Torque Limit at Main Circuit Voltage Drop			<input type="checkbox"/> Speed	<input type="checkbox"/> Position	<input type="checkbox"/> Torque
	Setting Range	Setting Unit	Default Setting	When Enabled	Classification	
	0 to 1,000	1 ms	100	Immediately	Setup	
Pn509 All Axes	Momentary Power Interruption Hold Time			<input type="checkbox"/> Speed	<input type="checkbox"/> Position	<input type="checkbox"/> Torque
	Setting Range	Setting Unit	Default Setting	When Enabled	Classification	
	20 to 50,000	1 ms	20	Immediately	Setup	

\* Set a percentage of the motor rated torque.

Note: If you will use the SEMI F47 function, set the time to 1,000 ms.



Important

- This function handles momentary power interruptions for the voltage and time ranges stipulated in SEMI F47. An uninterruptible power supply (UPS) is required as a backup for momentary power interruptions that exceed these voltage and time ranges.
- Set the host controller or SERVOPACK torque limit so that a torque reference that exceeds the specified acceleration torque will not be output when the power supply for the main circuit is restored.
- For a vertical axis, do not limit the torque to a value that is lower than the holding torque.
- This function limits torque within the range of the SERVOPACK's capability for power interruptions. It is not intended for use under all load and operating conditions. Set the parameters while monitoring operation on the actual machine.
- You can set the momentary power interruption hold time to increase the amount of time from when the power supply is turned OFF until power supply to the motor is stopped. To stop the power supply to the motor immediately, use the SV\_OFF (Servo ON) command.

## 6.4 Setting the Motor Maximum Speed

You can set the maximum speed of the Servomotor with the following parameter.

- Rotary Servomotors

Pn316	Maximum Motor Speed			Speed	Position	Torque
	Setting Range	Setting Unit	Default Setting	When Enabled	Classification	
	0 to 65,535	1 min <sup>-1</sup>	10,000	After restart	Setup	

- Linear Servomotors

Pn385	Maximum Motor Speed			Speed	Position	Force
	Setting Range	Setting Unit	Default Setting	When Enabled	Classification	
	1 to 100	100 mm/s	50	After restart	Setup	

You can achieve the following by lowering the maximum speed of the Servomotor.

- If the Servomotor speed exceeds the setting, an A.510 alarm (Overspeed) will occur.

Changing the setting of the parameter is effective in the following cases.

- To protect the machine by stopping machine operation with an alarm when the set speed is reached or exceeded
- To limit the speed so that the load is driven beyond the allowable moment of inertia  
Refer to relevant manual from the following list for the relationship between the speed and the allowable moment of inertia.

📖  $\Sigma$ -7-Series Rotary Servomotor Product Manual (Manual No.: SIEP S800001 36)

📖  $\Sigma$ -7-Series Direct Drive Servomotor Product Manual (Manual No.: SIEP S800001 38)

📖  $\Sigma$ -7-Series Linear Servomotor Product Manual (Manual No.: SIEP S800001 37)

## 6.5 Software Limits

You can set limits in the software for machine movement that do not use the overtravel signals (P-OT and N-OT). If a software limit is exceeded, an emergency stop will be executed in the same way as it is for overtravel.

You must make the following settings to use the software limits.

- You must enable the software limit function.
- You must set the software limits.

### 6.5.1 Setting to Enable/Disable Software Limits

You can use Pn801 = n.□□□X (Software Limit Selection) to enable and disable the software limit function. One of following commands must be executed to define the origin of the machine coordinate system before the software limits will operate. Otherwise, the software limit function will not operate even if a software limit is exceeded.

- The ZRET command has been executed.
- The POS\_SET command has been executed with REFE set to 1.
- If an absolute encoder is used, the SENS\_ON (Turn ON Sensor) command must have been completed.

Parameter		Meaning	When Enabled	Classification
Pn801	n.□□□0	Enable both forward and reverse software limits.	Immediately	Setup
	n.□□□1	Disable forward software limit.		
	n.□□□2	Disable reverse software limit.		
	n.□□□3 (default setting)	Disable both forward and reverse software limits.		

### 6.5.2 Setting the Software Limits

Software limits are set in both the forward and reverse directions.

The reverse software limit must be less than the forward software limit to set a limit in each direction.

Pn804	Forward Software Limit <span style="float: right;">[Position]</span>				
	Setting Range	Setting Unit	Default Setting	When Enabled	Classification
	-1,073,741,823 to 1,073,741,823	1 reference unit	1,073,741,823	Immediately	Setup
Pn806	Reverse Software Limit <span style="float: right;">[Position]</span>				
	Setting Range	Setting Unit	Default Setting	When Enabled	Classification
	-1,073,741,823 to 1,073,741,823	1 reference unit	-1,073,741,823	Immediately	Setup

### 6.5.3 Software Limit Check for References

You can enable or disable software limit checks for commands that have target position references, such as POSING or INTERPOLATE. If the target position exceeds a software limit, a deceleration stop will be performed from the position set as the software limit.

Parameter		Meaning	When Enabled	Classification
Pn801	n.□0□□ (default setting)	Do not perform software limit checks for references.	Immediately	Setup
	n.□1□□	Perform software limit checks for references.		

# 6.6 Selecting Torque Limits

You can limit the torque that is output by the Servomotor.

There are four different ways to limit the torque. These are described in the following table.

Limit Method	Outline	Control Method	Reference
Internal Torque Limits	The torque is always limited with the setting of a parameter.	Speed control, position control, or torque control	6.6.1
External Torque Limits	The torque is limited with an input signal from the host computer.		6.6.2
Limiting Torque with TLIM Data in Commands*	The TLIM data in a command is used to set the required torque limits.	Speed control or position control	-
Torque Limiting with P_CL and N_CL in the Servo Command Output Signals (SVCMD_IO)*	The P_CL and N_CL signals in the servo command output signals (SVCMD_IO) are used to set the required limits.	Speed control or position control	-

\* Refer to the following manual for details.

Σ-7-Series MECHATROLINK-III Communications Standard Servo Profile Command Manual (Manual No.: SIEP S800001 31)

Note: If you set a value that exceeds the maximum torque of the Servomotor, the torque will be limited to the maximum torque of the Servomotor.

## 6.6.1 Internal Torque Limits

If you use internal torque limits, the maximum output torque will always be limited to the specified forward torque limit (Pn402) and reverse torque limit (Pn403).

- Rotary Servomotors

Pn402	Forward Torque Limit			Speed	Position	Torque
	Setting Range	Setting Unit	Default Setting	When Enabled	Classification	
	0 to 800	1%*	800	Immediately	Setup	
Pn403	Reverse Torque Limit			Speed	Position	Torque
	Setting Range	Setting Unit	Default Setting	When Enabled	Classification	
	0 to 800	1%*	800	Immediately	Setup	

\* Set a percentage of the rated motor torque.

Note: If the setting of Pn402 or Pn403 is too low, the torque may be insufficient for acceleration or deceleration of the Servomotor.

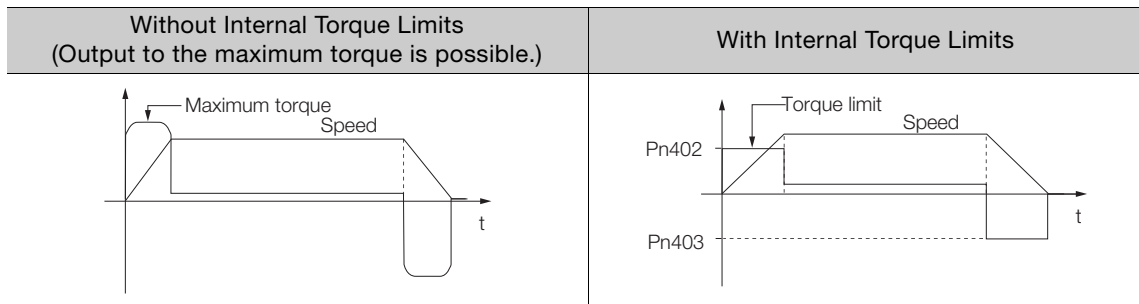

- Linear Servomotors

Pn483	Forward Force Limit			Speed	Position	Force
	Setting Range	Setting Unit	Default Setting	When Enabled	Classification	
	0 to 800	1%*	30	Immediately	Setup	
Pn484	Reverse Force Limit			Speed	Position	Force
	Setting Range	Setting Unit	Default Setting	When Enabled	Classification	
	0 to 800	1%*	30	Immediately	Setup	

\* Set a percentage of the rated motor force.

Note: If the setting of Pn483 or Pn484 is too low, the force may be insufficient for acceleration or deceleration of the Servomotor.

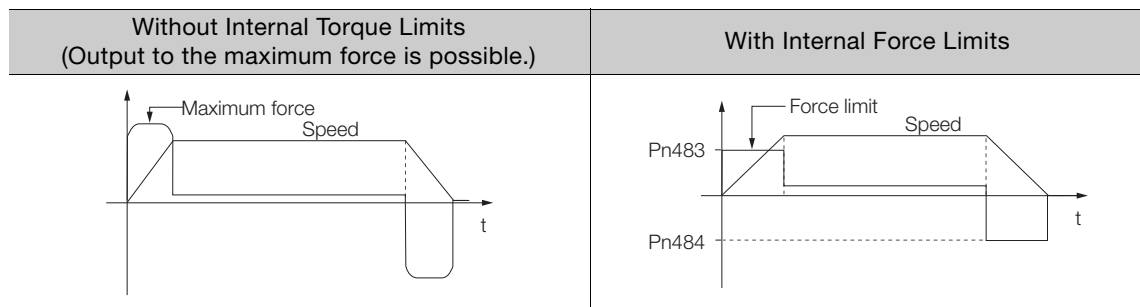

## 6.6.2 External Torque Limits

You can limit the torque only when required by the operating conditions of the machine by turning a signal ON and OFF.

You can use this for applications such as stopping on physical contact, or holding a workpiece with a robot.

### External Torque Limit Reference Signals

The /P-CL (Forward External Torque Limit) and /N-CL (Reverse External Torque Limit) signals are used as the external torque limit reference signals. The /P-CL signal is used for the forward torque limit and the /N-CL signal is used for the reverse torque limit.

Type	Signal	Connector Pin No.	Signal Status	Meaning
Input	/P-CL	Must be allocated.	ON (closed)	Applies the forward external torque limit. The torque is limited to the smaller of the settings of Pn402* <sup>1</sup> and Pn404.
			OFF (open)	Cancels the forward external torque limit. The torque is limited to the setting of Pn402* <sup>1</sup> .
Input	/N-CL	Must be allocated.	ON (closed)	Applies the reverse external torque limit. The torque is limited to the smaller of the settings of Pn403* <sup>2</sup> and Pn404.
			OFF (open)	Cancels the reverse external torque limit. The torque is limited to the setting of Pn403* <sup>2</sup> .

\*1. Pn483 is used for a Linear Servomotor.

\*2. Pn484 is used for a Linear Servomotor.

Note: You must allocate the /P-CL and /N-CL signals to use them. The parameters that you use depend on the allocation method.

Allocation Method	Parameter to Use
Σ-7S-Compatible I/O Signal Allocations	<ul style="list-style-type: none"> <li>Pn50A = n.□□□1 (Σ-7S-Compatible I/O Signal Allocations)</li> <li>Pn50B = n.□X□□ (/P-CL (Forward External Torque Limit Input) Signal Allocation)</li> <li>Pn50B = n.X□□□ (/N-CL (Reverse External Torque Limit Input) Signal Allocation)</li> </ul>
Multi-Axis I/O Signal Allocations	<ul style="list-style-type: none"> <li>Pn50A = n.□□□2 (Multi-Axis I/O Signal Allocations)</li> <li>Pn598 (/P-CL (Forward External Torque Limit Input) Signal Allocation)</li> <li>Pn599 (/N-CL (Reverse External Torque Limit Input) Signal Allocation)</li> </ul>

Refer to the following section for details on allocations.

6.1.1 Input Signal Allocations on page 6-3

## Setting the Torque Limits

The parameters that are related to setting the torque limits are given below.

- Rotary Servomotors

If the setting of Pn402 (Forward Torque Limit), Pn403 (Reverse Torque Limit), Pn404 (Forward External Torque Limit), or Pn405 (Reverse External Torque Limit) is too low, the torque may be insufficient for acceleration or deceleration of the Servomotor.

Pn402	Forward Torque Limit			<input type="checkbox"/> Speed	<input type="checkbox"/> Position	<input type="checkbox"/> Torque
	Setting Range	Setting Unit	Default Setting	When Enabled	Classification	
	0 to 800	1%*	800	Immediately	Setup	
Pn403	Reverse Torque Limit			<input type="checkbox"/> Speed	<input type="checkbox"/> Position	<input type="checkbox"/> Torque
	Setting Range	Setting Unit	Default Setting	When Enabled	Classification	
	0 to 800	1%*	800	Immediately	Setup	
Pn404	Forward External Torque Limit			<input type="checkbox"/> Speed	<input type="checkbox"/> Position	<input type="checkbox"/> Torque
	Setting Range	Setting Unit	Default Setting	When Enabled	Classification	
	0 to 800	1%*	100	Immediately	Setup	
Pn405	Reverse External Torque Limit			<input type="checkbox"/> Speed	<input type="checkbox"/> Position	<input type="checkbox"/> Torque
	Setting Range	Setting Unit	Default Setting	When Enabled	Classification	
	0 to 800	1%*	100	Immediately	Setup	

\* Set a percentage of the rated motor torque.

- Linear Servomotors

If the setting of Pn483 (Forward Force Limit), Pn484 (Reverse Force Limit), Pn404 (Forward External Force Limit), or Pn405 (Reverse External Force Limit) is too low, the force may be insufficient for acceleration or deceleration of the Servomotor.

Pn483	Forward Force Limit			<input type="checkbox"/> Speed	<input type="checkbox"/> Position	<input type="checkbox"/> Force
	Setting Range	Setting Unit	Default Setting	When Enabled	Classification	
	0 to 800	1%*	30	Immediately	Setup	
Pn484	Reverse Force Limit			<input type="checkbox"/> Speed	<input type="checkbox"/> Position	<input type="checkbox"/> Force
	Setting Range	Setting Unit	Default Setting	When Enabled	Classification	
	0 to 800	1%*	30	Immediately	Setup	
Pn404	Forward External Force Limit			<input type="checkbox"/> Speed	<input type="checkbox"/> Position	<input type="checkbox"/> Force
	Setting Range	Setting Unit	Default Setting	When Enabled	Classification	
	0 to 800	1%*	100	Immediately	Setup	
Pn405	Reverse External Force Limit			<input type="checkbox"/> Speed	<input type="checkbox"/> Position	<input type="checkbox"/> Force
	Setting Range	Setting Unit	Default Setting	When Enabled	Classification	
	0 to 800	1%*	100	Immediately	Setup	

\* Set a percentage of the rated motor force.

## Changes in the Output Torque for External Torque Limits

The following table shows the changes in the output torque when the internal torque limit is set to 800%.

- Rotary Servomotors

In this example, the Servomotor direction is set to Pn000 = n.□□□0 (Use CCW as the forward direction).

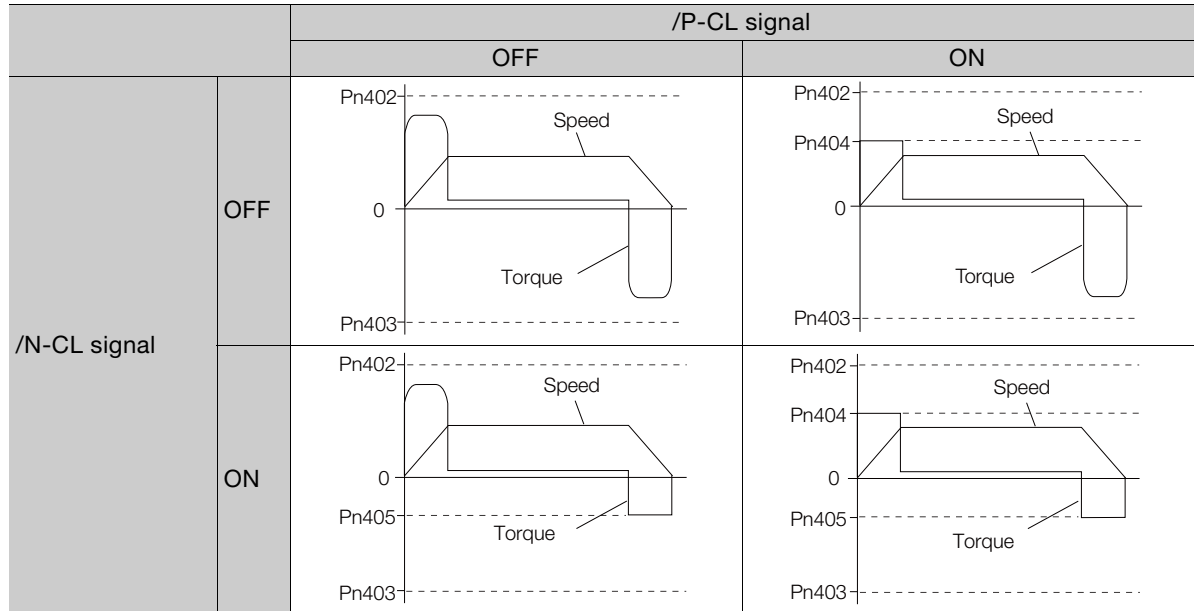

- Linear Servomotors

In this example, the Servomotor direction is set to Pn000 = n.□□□0 (Use the direction in which the linear encoder counts up as the forward direction).

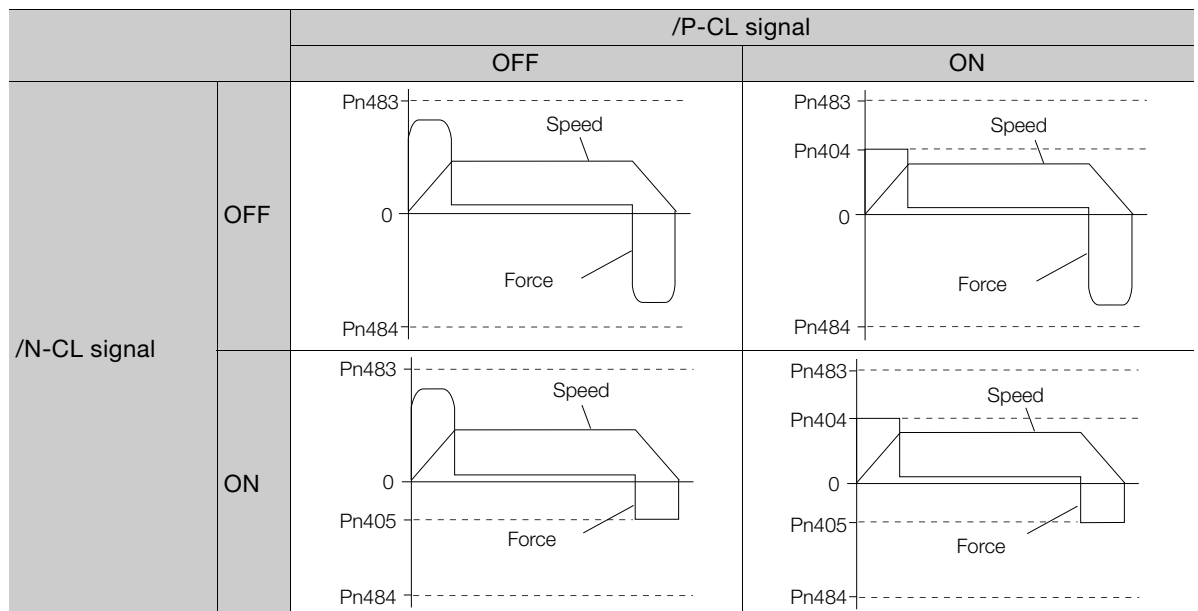

## 6.6.3 /CLT (Torque Limit Detection) Signal

This section describes the /CLT signal, which indicates the status of limiting the motor output torque.

Type	Signal	Connector Pin No.	Signal Status	Meaning
Output	/CLT	Must be allocated.	ON (closed)	The motor output torque is being limited.
			OFF (open)	The motor output torque is not being limited.

Note: You must allocate the /CLT signal to use it. The parameters that you use depend on the allocation method.

Allocation Method	Parameter to Use
$\Sigma$ -7S-Compatible I/O Signal Allocations	<ul style="list-style-type: none"> <li>Pn50A = n.□□□1 (<math>\Sigma</math>-7S-Compatible I/O Signal Allocations)</li> <li>Pn50F = n.□□□X (/CLT (Torque Limit Detection Output) Signal Allocation)</li> </ul>
Multi-Axis I/O Signal Allocations	<ul style="list-style-type: none"> <li>Pn50A = n.□□□2 (Multi-Axis I/O Signal Allocations)</li> <li>Pn5B4 (/CLT (Torque Limit Detection Output) Signal Allocation)</li> </ul>

Refer to the following section for details.

 [6.1.2 Output Signal Allocations](#) on page 6-6



## 6.7 Absolute Encoders

The absolute encoder records the current position of the stop position even when the power supply is OFF.

With a system that uses an absolute encoder, the host controller can monitor the current position. Therefore, it is not necessary to perform an origin return operation when the power supply to the system is turned ON.

There are four types of encoders for Rotary Servomotors. The usage of the encoder is specified in Pn002 = n.□X□□.

SERVOPACKs with software version 0023 or higher support batteryless absolute encoders.

Refer to the following section for encoder models.

 ■ Encoder Resolution on page 5-45

### • Parameter Settings When Using an Incremental Encoder

Parameter	Meaning	When Enabled	Classification
Pn002	n.□0□□ (default setting)	After restart	Setup
	n.□1□□		
	n.□2□□		

### • Parameter Settings When Using a Single-Turn Absolute Encoder

Parameter	Meaning	When Enabled	Classification
Pn002	n.□0□□ (default setting)	After restart	Setup
	n.□1□□		
	n.□2□□		

### • Parameter Settings When Using a Multiturn Absolute Encoder

Parameter	Meaning	When Enabled	Classification
Pn002	n.□0□□ (default setting)	After restart	Setup
	n.□1□□		
	n.□2□□		

### • Parameter Settings When Using a Batteryless Multiturn Absolute Encoder

Parameter	Meaning	When Enabled	Classification
Pn002	n.□0□□ (default setting)	After restart	Setup
	n.□1□□		
	n.□2□□		

## NOTICE

- **Install a battery at either the host controller or on the Encoder Cable.**  
If you install batteries both at the host controller and on the Encoder Cable at the same time, you will create a loop circuit between the batteries, resulting in a risk of damage or burning.

---

## 6.7.1 Connecting an Absolute Encoder

---

You can get the position data from the absolute encoder with MECHATROLINK communications.

Refer to the following section for information on connecting absolute encoders.

 4.4.3 Wiring the SERVOPACK to the Encoder on page 4-22

---

## 6.7.2 Structure of the Position Data of the Absolute Encoder

---

The position data of the absolute encoder is the position coordinate from the origin of the absolute encoder.

The position data from the absolute encoder contains the following two items.

- The number of rotations from the origin of the encoder coordinate system (called the multiturn data)
- The position (number of pulses) within one rotation

The position data of the absolute encoder is as follows:

Position data of absolute encoder = Multiturn data × Number of pulses within one encoder rotation (encoder resolution) + Position (number of pulses) within one rotation.

For a single-turn absolute encoder, the multiturn data is 0.

---

## 6.7.3 Reading the Position Data from the Absolute Encoder

---

The SENS\_ON (Turn ON Sensor) command is used to read the position data from the absolute encoder.

---

## 6.7.4 Multiturn Limit Setting

---

The multiturn limit is used in position control for a turntable or other rotating body.

For example, consider a machine that moves the turntable shown in the following diagram in only one direction.

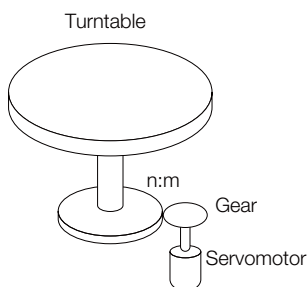

Because the turntable moves in only one direction, the upper limit to the number of rotations that can be counted by an absolute encoder will eventually be exceeded.

The multiturn limit is used in cases like this to prevent fractions from being produced by the integral ratio of the number of Servomotor rotations and the number of turntable rotations.

For a machine with a ratio of n:m between the number of Servomotor rotations and the number of turntable rotations, as shown above, the value of m minus 1 will be the setting for the multiturn limit setting (Pn205).

Multiturn limit (Pn205) = m - 1

If m = 100 and n = 3 (i.e., the turntable rotates three times for each 100 Servomotor rotations), the relationship between the number of Servomotor rotations and the number of turntable rota-

tions would be as shown below.

Set Pn205 to 99.

$$Pn205 = 100 - 1 = 99$$

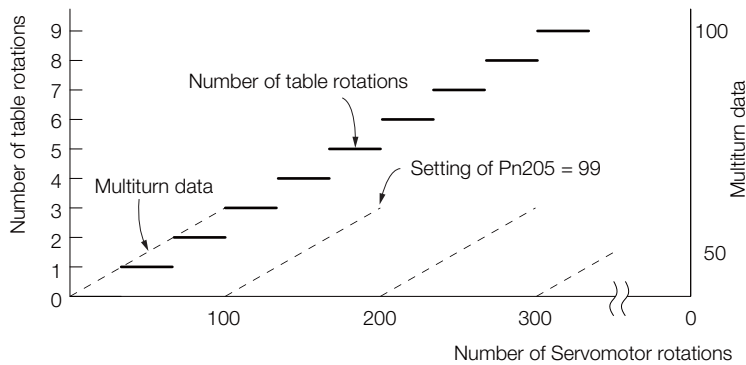

Pn205	Multiturn Limit			Speed	Position	Torque
	Setting Range	Setting Unit	Default Setting	When Enabled	Classification	
	0 to 65,535	1 Rev	65,535	After restart	Setup	

Note: This parameter is enabled when you use an absolute encoder.

The data will change as shown below when this parameter is set to anything other than the default setting.

- If the Servomotor operates in the reverse direction when the multiturn data is 0, the multiturn data will change to the value set in Pn205.
- If the motor operates in the forward direction when the multiturn data is at the value set in Pn205, the multiturn data will change to 0.

Set Pn205 to one less than the desired multiturn data.

If you change the multiturn limit in Pn205, an A.CC0 alarm (Multiturn Limit Disagreement) will be displayed because the setting disagrees with the value in the encoder. Refer to the following section for the procedure to change the multiturn limit settings in the encoder.

6.7.5 Multiturn Limit Disagreement Alarm (A.CC0) on page 6-30

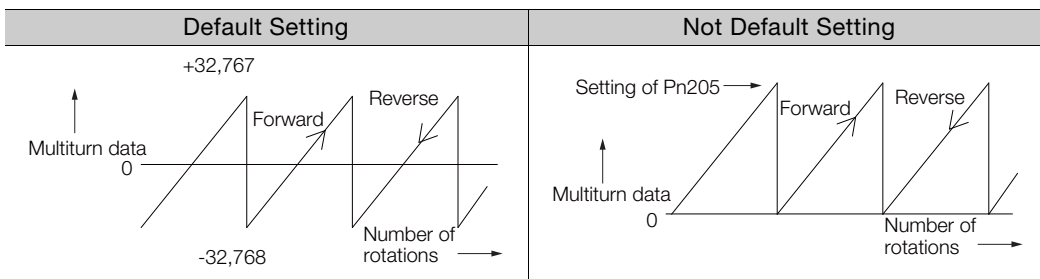

**Information** The multiturn data will always be 0 in the following cases. It is not necessary to reset the absolute encoder in these cases.

- When you use a single-turn absolute encoder
  - When the encoder is set to be used as a single-turn absolute encoder (Pn002 = n.□2□□)
- Absolute encoder-related alarms (A.810 and A.820) will not occur.

## 6.7.5 Multiturn Limit Disagreement Alarm (A.CC0)



If you change the multiturn limit in Pn205 (Multiturn Limit), an A.CC0 alarm (Multiturn Limit Disagreement) will be displayed because the setting disagrees with the value in the encoder.

Display	Name	Meaning
A.CC0	Multiturn Limit Disagreement	Different multiturn limits are set in the encoder and SERVO-PACK.

If this alarm is displayed, use the following procedure to change the multiturn limit in the encoder to the same value as the setting of Pn205.

### Applicable Tools

The following table lists the tools that you can use to set the multiturn limit and the applicable tool functions.

Tool	Function	Operating Procedure Reference
Digital Operator	Fn013	 $\Sigma$ -7-Series Digital Operator Operating Manual (Manual No.: SIEP S800001 33)
SigmaWin+	<b>Setup - Multiturn Limit Setting</b>	 <i>Operating Procedure</i> on page 6-30

This setting can be made with the MEM\_WR (Write Memory) command. Refer to the following manual for information on the MEM\_WR (Write Memory) command.

  $\Sigma$ -7-Series MECHATROLINK-III Communications Standard Servo Profile Command Manual (Manual No.: SIEP S800001 31)

### Operating Procedure

Use the following procedure to adjust the multiturn limit setting.

1. Click the  Servo Drive Button in the workspace of the Main Window of the SigmaWin+.
2. Select **Multiturn Limit Setting** in the Menu Dialog Box.  
The Multiturn Limit Setting Dialog Box will be displayed.
3. Click the **Continue** Button.

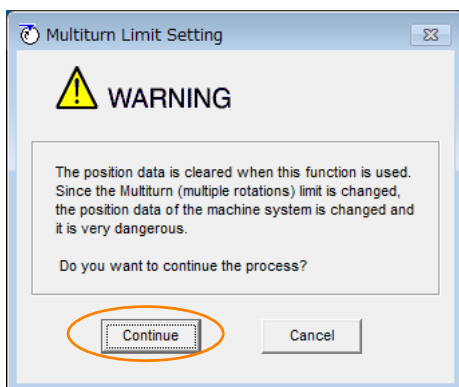

Click the **Cancel** Button to cancel setting the multiturn limit.  
The Main Window will return.

## 4. Change the setting.

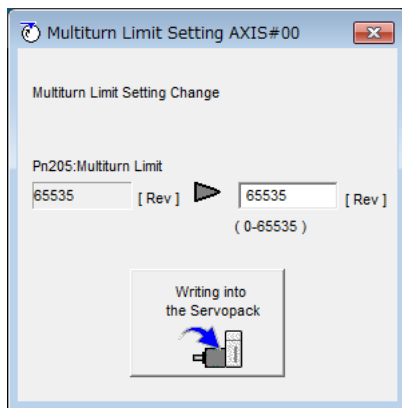

## 5. Click the Writing into the Servopack Button.

## 6. Click the OK Button.

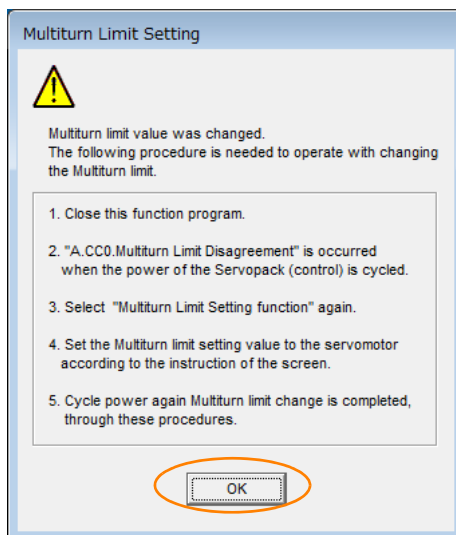

## 7. Turn the power supply to the SERVOPACK OFF and ON again.

An A.CC0 alarm (Multiturn Limit Disagreement) will occur because setting the multiturn limit in the Servomotor is not yet completed even though the setting has been changed in the SERVOPACK.

## 8. Display the Multiturn Limit Setting in the Menu Dialog Box.

## 9. Click the Continue Button.

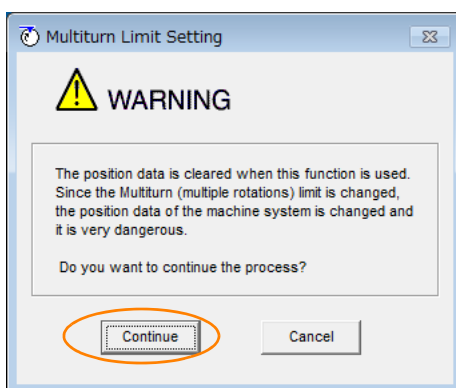

**10. Click the Writing into the servomotor Button.**

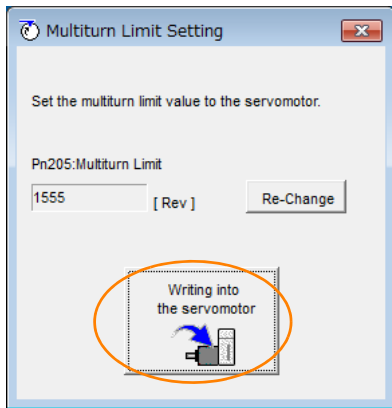

Click the **Re-change** Button to change the setting.

**11. Click the OK Button.**

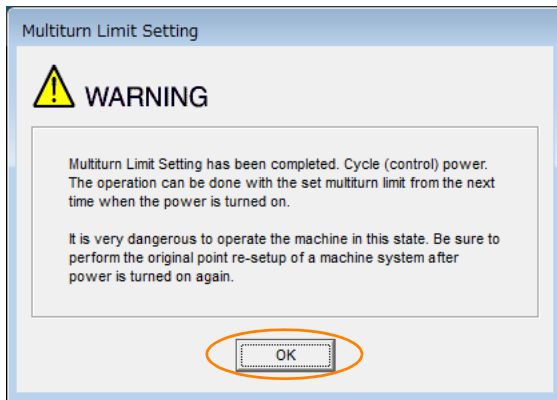

This concludes the procedure to set the multiturn limit.

## 6.8 Absolute Linear Encoders

The absolute linear encoder records the current position of the stop position even when the power supply is OFF.

With a system that uses an absolute linear encoder, the host controller can monitor the current position. Therefore, it is not necessary to perform an origin return operation when the power supply to the system is turned ON.

There are three types of linear encoders for Linear Servomotors. The usage of the linear encoder is specified in Pn002 = n.□X□□.

Refer to the following section for linear encoder models.

 ■ *Feedback Resolution of Linear Encoder on page 5-46*

### • Parameter Settings When Using an Incremental Linear Encoder

Parameter		Meaning	When Enabled	Classification
Pn002	n.□0□□ (default setting)	Use the encoder as an incremental linear encoder.	After restart	Setup
	n.□1□□	Use the encoder as an incremental linear encoder.		

### • Parameter Settings When Using an Absolute Linear Encoder

Parameter		Meaning	When Enabled	Classification
Pn002	n.□0□□ (default setting)	Use the encoder as an absolute linear encoder.	After restart	Setup
	n.□1□□	Use the encoder as an incremental linear encoder.		

## 6.8.1 Connecting an Absolute Linear Encoder

You can get the position data from the absolute linear encoder with MECHATROLINK communications.

Refer to the following section for information on connecting absolute linear encoders.

 *4.4.3 Wiring the SERVOPACK to the Encoder on page 4-22*

## 6.8.2 Structure of the Position Data of the Absolute Linear Encoder

The position data of the absolute linear encoder is the distance (number of pulses) from the origin of the absolute linear encoder.

The position data is signed 36-bit data.

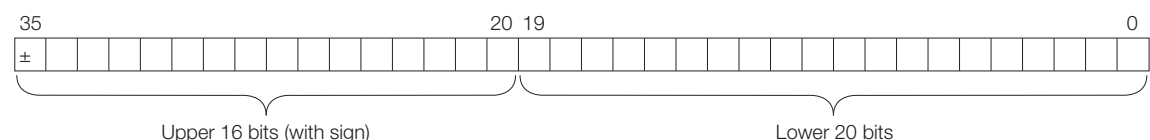

When the SERVOPACK sends the position data, it sends the upper 16-bit data (with sign) separately from the lower 20-bit data.

## 6.8.3 Reading the Position Data from the Absolute Linear Encoder

The SENS\_ON (Turn ON Sensor) command is used to read the position data from the absolute linear encoder.

## 6.9 Software Reset

You can reset the SERVOPACK internally with the software. A software reset is used when resetting alarms and changing the settings of parameters that normally require turning the power supply to the SERVOPACK OFF and ON again. This can be used to change those parameters without turning the power supply to the SERVOPACK OFF and ON again.



The software reset applies to both axes A and B.  
If you reset the software, it will be reset for both axes.

### Information

1. Always confirm that the servo is OFF and that the Servomotor is stopped before you start a software reset.
2. This function resets the SERVOPACK independently of the host controller. The SERVOPACK carries out the same processing as when the power supply is turned ON and outputs the ALM (Servo Alarm) signal. The status of other output signals may be forcibly changed.
3. When you execute a software reset, the SERVOPACK will not respond for approximately five seconds.  
Before you execute a software reset, check the status of the SERVOPACK and Servomotor and make sure that no problems will occur.

### 6.9.1 Preparations

Always check the following before you perform a software reset.

- The servo must be OFF for both axis A and axis B.
- The motor must be stopped.

### 6.9.2 Applicable Tools

The following table lists the tools that you can use to perform a software reset and the applicable tool functions.

Tool	Function	Operating Procedure Reference
Digital Operator	Fn030	$\Sigma$ -7-Series Digital Operator Operating Manual (Manual No.: SIEP S80001 33)
SigmaWin+	<b>Setup - Software Reset</b>	6.9.3 Operating Procedure on page 6-35



## 6.9.3 Operating Procedure

There are the following two methods that you can use to perform a software reset.

- Direct connection to the SERVOPACK
- Connection through a controller

The procedure for each method is given below.

### Direct Connection to the SERVOPACK

1. Click the  Servo Drive Button in the workspace of the Main Window of the SigmaWin+.
2. Select **Software Reset** in the Menu Dialog Box.  
The Software Reset Dialog Box will be displayed.
3. Click the **Execute** Button.



Click the **Cancel** Button to cancel the software reset. The Main Window will return.

4. Click the **Execute** Button.

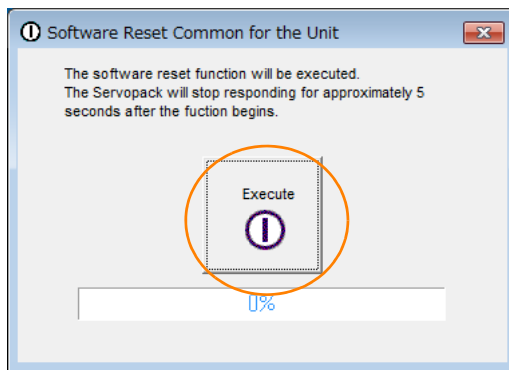

5. Click the **OK** Button to end the software reset operation.  
All settings including parameters will have been re-calculated. When you finish this operation, disconnect the SigmaWin+ from the SERVOPACK, and then connect it again.

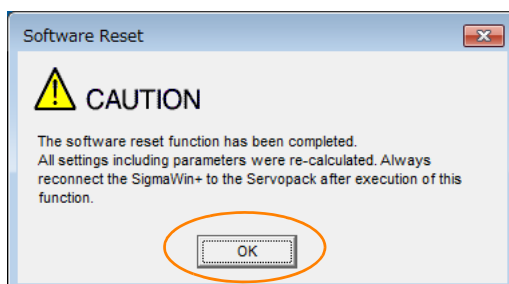

This concludes the procedure to reset the software.

## Connection through a Controller

1. Click the  Servo Drive Button in the workspace of the Main Window of the SigmaWin+.
2. Select **Software Reset** in the Menu Dialog Box.  
The Software Reset Dialog Box will be displayed.
3. Click the **Execute** Button.

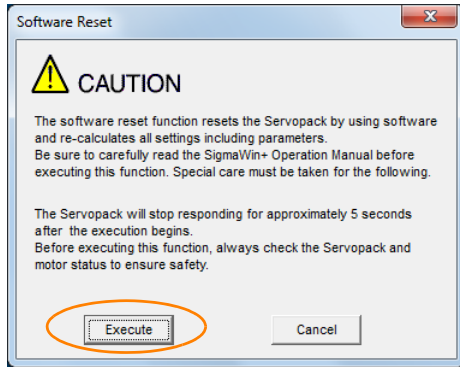

Click the **Cancel** Button to cancel the software reset. The Main Window will return.

4. Select the **Reset MECHATROLINK** communication Check Box.

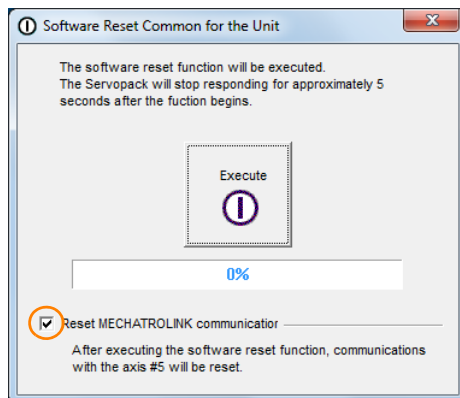

5. Click the **Execute** Button.



**Important** If you perform a software reset without resetting MECHATROLINK communications, a communications error will occur between the controller and SERVOPACK, and communications will no longer be possible. Always select the **Reset MECHATROLINK communication** Check Box and reset MECHATROLINK communications as well.

6. Click the **OK** Button.

All settings including parameters will have been re-calculated. When you finish this operation, disconnect the SigmaWin+ from the SERVOPACK, and then connect it again.

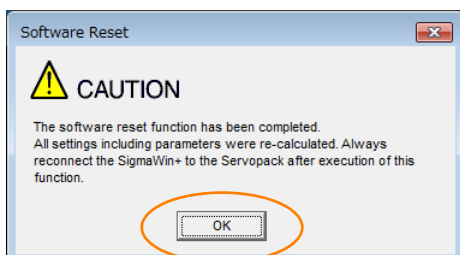

This concludes the procedure to reset the software.

## 6.10 Initializing the Vibration Detection Level

You can detect machine vibration during operation to automatically adjust the settings of Pn312 or Pn384 (Vibration Detection Level) to detect A.520 alarms (Vibration Alarm) and A.911 warnings (Vibration Warning) more precisely.

This function detects specific vibration components in the Servomotor speed.

Parameter		Meaning	When Enabled	Classification
Pn310	n.□□□0 (default setting)	Do not detect vibration.	Immediately	Setup
	n.□□□1	Output a warning (A.911) if vibration is detected.		
	n.□□□2	Output an alarm (A.520) if vibration is detected.		

If the vibration exceeds the detection level calculated with the following formula, an alarm or warning occurs according to Pn310 (Vibration Detection Selection).

- Rotary Servomotors

$$\text{Detection level} = \frac{\text{Vibration detection level (Pn312 [min-1])} \times \text{Vibration detection sensitivity (Pn311 [\%])}{100}$$

- Linear Servomotors

$$\text{Detection level} = \frac{\text{Vibration detection level (Pn384 [mm/s])} \times \text{Vibration detection sensitivity (Pn311 [\%])}{100}$$

Use this function only if A.520 or A.911 alarms are not output at the correct times when vibration is detected with the default vibration detection level (Pn312 or Pn384).

There will be discrepancies in the detection sensitivity for vibration alarms and warnings depending on the condition of your machine. If there is a discrepancy, use the above formula to adjust Pn311 (Vibration Detection Sensitivity).

Pn311	Vibration Detection Sensitivity			
	Setting Range	Setting Unit	Default Setting	When Enabled
	50 to 500	1%	100	Immediately

### Information

1. Vibration may not be detected because of unsuitable servo gains. Also, not all kinds of vibrations can be detected.
2. Set a suitable moment of inertia ratio (Pn103). An unsuitable setting may result in falsely detecting or not detecting vibration alarms or vibration warnings.
3. To use this function, you must input the actual references that will be used to operate your system.
4. Execute this function under the operating conditions for which you want to set the vibration detection level.
5. Execute this function while the Servomotor is operating at 10% of its maximum speed or faster.

### 6.10.1 Preparations

Always check the following before you initialize the vibration detection level.

- The parameters must not be write prohibited.
- The test without a motor function must be disabled (Pn00C = n.□□□0).

### 6.10.2 Applicable Tools

The following table lists the tools that you can use to initialize the vibration detection level and the applicable tool functions.

Tool	Function	Operating Procedure Reference
Digital Operator	Fn01B	Σ-7-Series Digital Operator Operating Manual (Manual No.: SIEP S800001 33)

Tool	Function	Operating Procedure Reference
SigmaWin+	<b>Setup - Initialize Vibration Detection Level</b>	 6.10.3 Operating Procedure on page 6-38

## 6.10.3 Operating Procedure

Use the following procedure to initialize the vibration detection level.

1. Click the  Servo Drive Button in the workspace of the Main Window of the SigmaWin+.
2. Select **Initialize Vibration Detection Level** in the Menu Dialog Box.  
The Initialize Vibration Detection Level Dialog Box will be displayed.
3. Select **Pn311: Vibration Detection Sensitivity** and **Pn310: Vibration Detection Selections** and then click the **Detection Start** Button.  
A setting execution standby mode will be entered.

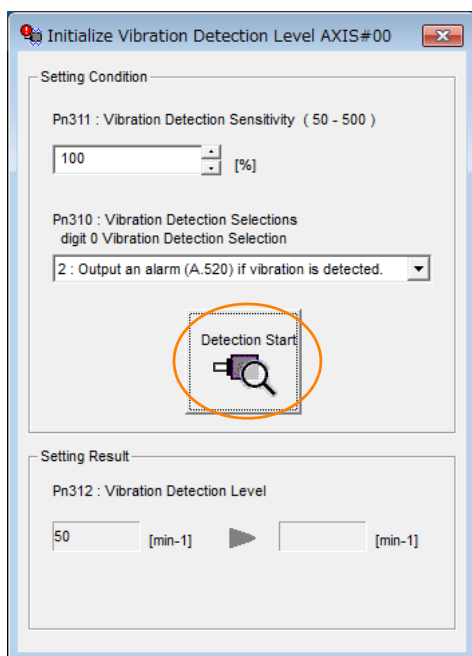

4. Click the **Execute** Button.

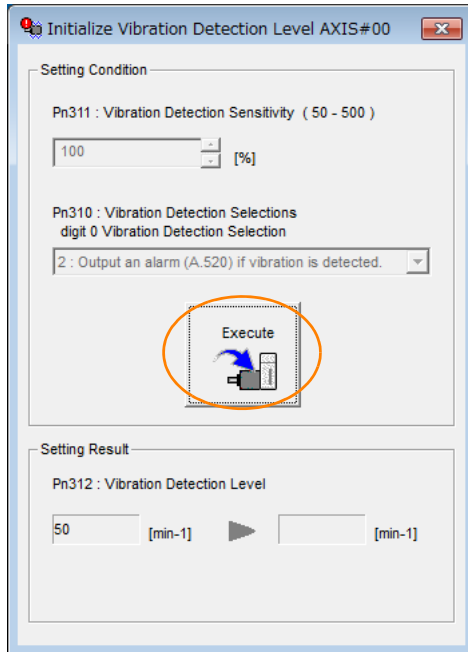

The newly set vibration detection level will be displayed and the value will be saved in the SERVO-PACK.

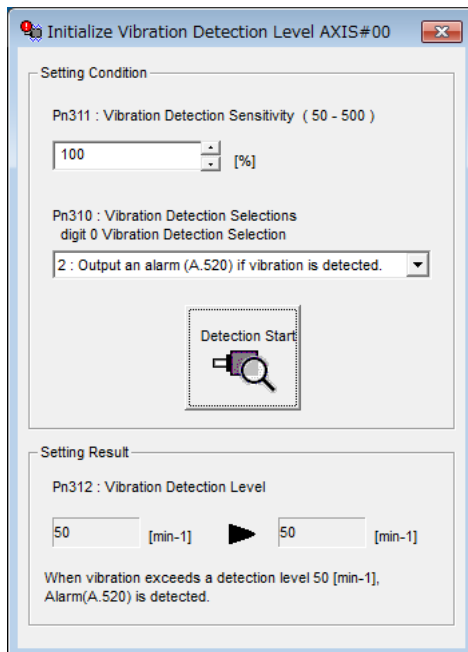

This concludes the procedure to initialize the vibration detection level.

## 6.10.4 Related Parameters

The following three items are given in the following table.

- Parameters Related to this Function  
These are the parameters that are used or referenced when this function is executed.
- Changes during Function Execution  
Not allowed: The parameter cannot be changed using the SigmaWin+ or other tool while this function is being executed.  
Allowed: The parameter can be changed using the SigmaWin+ or other tool while this function is being executed.
- Automatic Changes after Function Execution  
Yes: The parameter is automatically set or adjusted after execution of this function.

## 6.10 Initializing the Vibration Detection Level

---

### 6.10.4 Related Parameters

No: The parameter is not automatically set or adjusted after execution of this function.

Parameter	Name	Setting Changes	Automatic Changes
Pn311	Vibration Detection Sensitivity	Allowed	No
Pn312	Vibration Detection Level	Not allowed	Yes
Pn384	Vibration Detection Level	Not allowed	Yes

## 6.11 Adjusting the Motor Current Detection Signal Offset

The motor current detection signal offset is used to reduce ripple in the torque. You can adjust the motor current detection signal offset either automatically or manually.

### 6.11.1 Automatic Adjustment

Perform this adjustment only if highly accurate adjustment is required to reduce torque ripple. You can specify the axis or axes to automatically adjust. It is normally not necessary to adjust this offset.



Execute the automatic offset adjustment if the torque ripple is too large when compared with other SERVOPACKs.

#### Information

The offset does not use a parameter, so it will not change even if the parameter settings are initialized.

### Preparations

Always check the following before you automatically adjust the motor current detection signal offset.

- The parameters must not be write prohibited.
- The servo must be in ready status.
- The servo must be OFF.

### Applicable Tools

The following table lists the tools that you can use to automatically adjust the offset and the applicable tool functions.

Tool	Function	Operating Procedure Reference
Digital Operator	Fn00E	$\Sigma$ -7-Series Digital Operator Operating Manual (Manual No. S1EP S800001 33)
SigmaWin+	<b>Setup - Adjust Offset - Adjust the Motor Current Detection Offset</b>	Operating Procedure on page 6-41

### Operating Procedure

Use the following procedure to automatically adjust the motor current detection signal offset.

1. Click the Servo Drive Button in the workspace of the Main Window of the SigmaWin+.
2. Select **Adjust the Motor Current Detection Signal Offsets** in the Menu Dialog Box. The Adjust the Motor Current Detection Signal Offsets Dialog Box will be displayed.

3. Click the **Continue** Button.

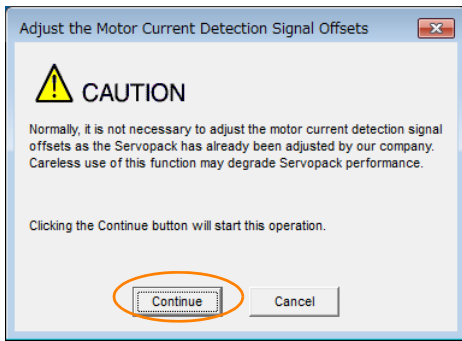

4. Click the **Automatic Adjustment** Tab in the Adjust the Motor Current Detection Signal Offsets Dialog Box.

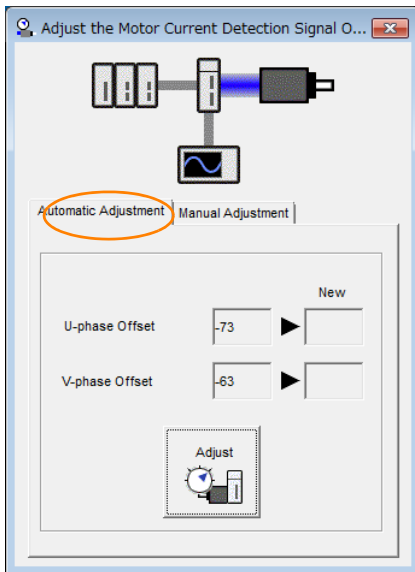

5. Click the **Adjust** Button.

The values that result from automatic adjustment will be displayed in the **New** Boxes.

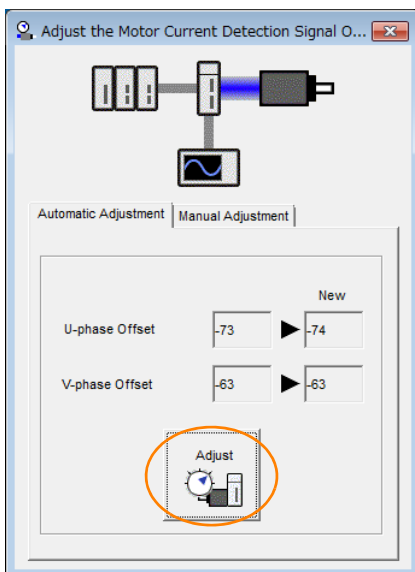

This concludes the procedure to automatically adjust the motor current detection signal offset.



## 6.11.2 Manual Adjustment

You can use this function if you automatically adjust the motor current detection signal offset and the torque ripple is still too large. You can specify the axis or axes to manually adjust.



Important

If the offset is incorrectly adjusted with this function, the Servomotor characteristics may be adversely affected.

Observe the following precautions when you manually adjust the offset.

- Operate the Servomotor at a speed of approximately 100 min<sup>-1</sup>.
- Adjust the offset while monitoring the torque reference with the analog monitor until the ripple is minimized.
- Adjust the offsets for the phase-U current and phase-V current of the Servomotor so that they are balanced. Alternately adjust both offsets several times.

Information

The offset does not use a parameter, so it will not change even if the parameter settings are initialized.

### Preparations

Always check the following before you manually adjust the motor current detection signal offset.

- The parameters must not be write prohibited.

### Applicable Tools

The following table lists the tools that you can use to manually adjust the offset and the applicable tool functions.

Tool	Function	Operating Procedure Reference
Digital Operator	Fn00F	$\Sigma$ -7-Series Digital Operator Operating Manual (Manual No.: SIEP S800001 33)
SigmaWin+	<b>Setup - Adjust Offset - Adjust the Motor Current Detection Offset</b>	Operating Procedure on page 6-43

### Operating Procedure

Use the following procedure to manually adjust the motor current detection signal offset.

1. Operate the Servomotor at approximately 100 min<sup>-1</sup>.
2. Click the Servo Drive Button in the workspace of the Main Window of the SigmaWin+.
3. Select **Adjust the Motor Current Detection Signal Offsets** in the Menu Dialog Box. The Adjust the Motor Current Detection Signal Offsets Dialog Box will be displayed.
4. Click the **Continue** Button.

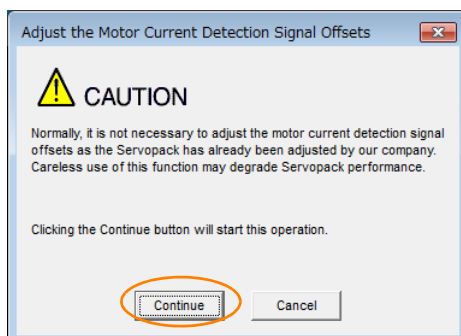

5. Click the **Manual Adjustment** Tab in the Adjust the Motor Current Detection Signal Offsets Dialog Box.

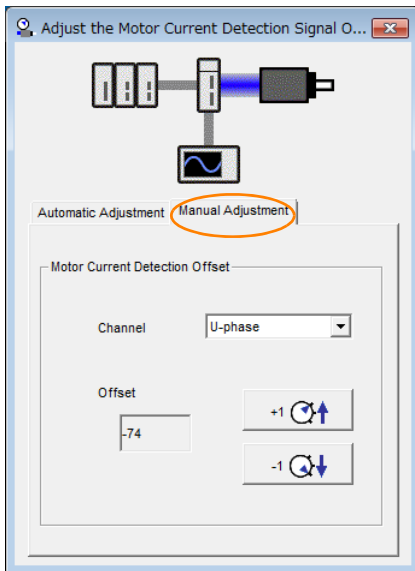

6. Set the **Channel** Box in the **Motor Current Detection Offset** Area to **U-phase**.
7. Use the **+1** and **-1** Buttons to adjust the offset for phase U.  
Change the offset by about 10 in the direction that reduces the torque ripple.  
Adjustment range: -512 to +511
8. Set the **Channel** Box in the **Motor Current Detection Offset** Area to **V-phase**.
9. Use the **+1** and **-1** Buttons to adjust the offset for phase V.  
Change the offset by about 10 in the direction that reduces the torque ripple.
10. Repeat steps 6 to 9 until the torque ripple cannot be decreased any further regardless of whether you increase or decrease the offsets.
11. Reduce the amount by which you change the offsets each time and repeat steps 6 to 9.

This concludes the procedure to manually adjust the motor current detection signal offset.

## 6.12 Forcing the Motor to Stop

You can force the Servomotor to stop for a signal from the host controller or an external device.

To force the motor to stop, you must allocate the FSTP (Forced Stop Input) signal in Pn516 = n.□□□X. You can specify one of the following stopping methods: dynamic brake (DB), coasting to a stop, or decelerating to a stop.

Note: Forcing the motor to stop is not designed to comply with any safety standard. In this respect, it is different from the hard wire base block (HWBB).

**Information** Panel Operator and Digital Operator Displays  
When a forced stop is performed, the panel and the Digital Operator will display FSTP.



### CAUTION

- To prevent accidents that may result from contact faults or disconnections, use a normally closed switch for the Forced Stop Input signal.

### 6.12.1 FSTP (Forced Stop Input) Signal

Classification	Signal	Connector Pin No.	Signal Status	Description
Input	FSTP	Must be allocated.	ON (closed)	Drive is enabled (normal operation).
			OFF (open)	The motor is stopped.

Note: You must allocate the FSTP signal to use it. The parameters that you use depend on the allocation method.

Allocation Method	Parameters to Use
Σ-7S-compatible I/O signal allocations	<ul style="list-style-type: none"> <li>• Pn50A = n.□□□1 (Σ-7S-Compatible I/O Signal Allocations)</li> <li>• Pn516 = n.□□□X (FSTP (Forced Stop Input) Signal Allocation)</li> </ul>
Multi-axis I/O signal allocations	<ul style="list-style-type: none"> <li>• Pn50A = n.□□□2 (Multi-Axis I/O Signal Allocations)</li> <li>• Pn597 (FSTP (Forced Stop Input) Signal Allocation)</li> </ul>

Refer to the following section for details.

**6.1.1 Input Signal Allocations** on page 6-3

## 6.12.2 Stopping Method Selection for Forced Stops

Use Pn00A = n.□□X□ (Stopping Method for Forced Stops) to set the stopping method for forced stops.

Parameter		Description	When Enabled	Classification
Pn00A	n.□□0□	Apply the dynamic brake or coast the motor to a stop (use the stopping method set in Pn001 = n.□□□X).	After restart	Setup
	n.□□1□ (default setting)	Decelerate the motor to a stop using the torque set in Pn406 as the maximum torque. Use the setting of Pn001 = n.□□□X for the status after stopping.		
	n.□□2□	Decelerate the motor to a stop using the torque set in Pn406 as the maximum torque and then let the motor coast.		
	n.□□3□	Decelerate the motor to a stop using the deceleration time set in Pn30A. Use the setting of Pn001 = n.□□□X for the status after stopping.		
	n.□□4□	Decelerate the motor to a stop using the deceleration time set in Pn30A and then let the motor coast.		

Note: You cannot decelerate a Servomotor to a stop during torque control. For torque control, the Servomotor will be stopped with the dynamic braking or coast to a stop according to the setting of Pn001 = n.□□□X (Servo OFF or Alarm Group 1 Stopping Method).

### Stopping the Servomotor by Setting Emergency Stop Torque (Pn406)

To stop the Servomotor by setting emergency stop torque, set Pn406 (Emergency Stop Torque).

If Pn001 = n.□□X□ is set to 1 or 2, the Servomotor will be decelerated to a stop using the torque set in Pn406 as the maximum torque.

The default setting is 800%. This setting is large enough to allow you to operate the Servomotor at the maximum torque. However, the maximum emergency stop torque that you can actually use is the maximum torque of the Servomotor.

Pn406	Emergency Stop Torque			Speed	Position
	Setting Range	Setting Unit	Default Setting	When Enabled	Classification
	0 to 800	1%*	800	Immediately	Setup

\* Set a percentage of the motor rated torque.

### Stopping the Servomotor by Setting the Deceleration Time for Servo OFF and Forced Stops (Pn30A)

To specify the Servomotor deceleration time and use it to stop the Servomotor, set Pn30A (Deceleration Time for Servo OFF and Forced Stops).

Pn30A	Deceleration Time for Servo OFF and Forced Stops			Speed	Position
	Setting Range	Setting Unit	Default Setting	When Enabled	Classification
	0 to 10,000	1 ms	0	Immediately	Setup

If you set Pn30A to 0, the Servomotor will be stopped with a zero speed.

The deceleration time that you set in Pn30A is the time to decelerate the Servomotor from the maximum motor speed.

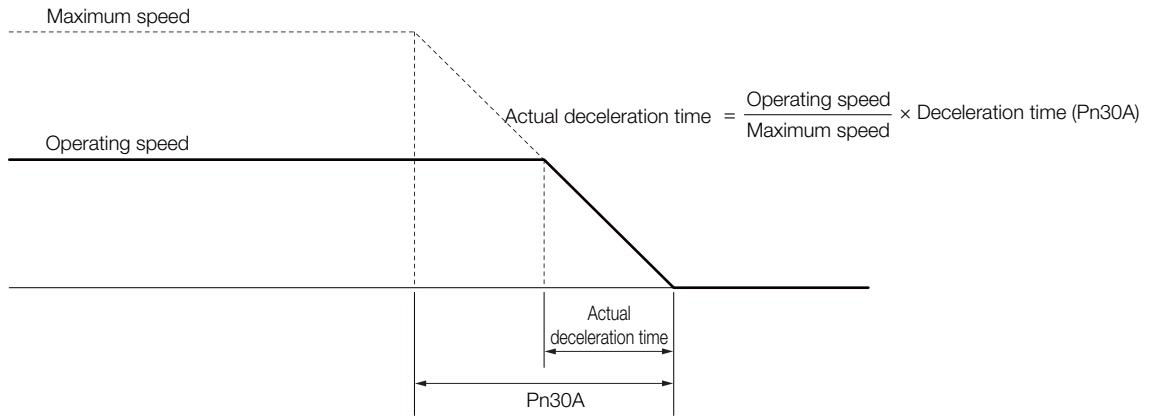

### 6.12.3 Resetting Method for Forced Stops

This section describes the reset methods that can be used after stopping operation for an FSTP (Forced Stop Input) signal.

If the FSTP (Forced Stop Input) signal is OFF and the SV\_ON (Servo ON) command is sent, the forced stop state will be maintained even after the FSTP signal is turned ON.

Send the SV\_OFF (Servo OFF) command to place the SERVOPACK in the base block (BB) state and then send the SV\_ON (Servo ON) command.

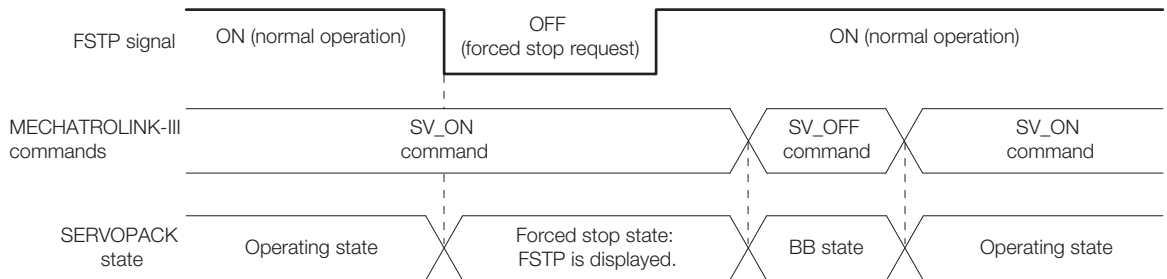

## 6.13 Overheat Protection

Overheat protection detects an A.93B warning (Overheat Warning) and an A.862 alarm (Overheat Alarm) by monitoring the overheat protection input signal from a Yaskawa SGLFW2 Linear Servomotor or from a sensor attached to the machine.

SERVOPACKs with software version 0023 or higher support overheat protection.

When you use overheat protection, you must wire the overheat protection input (TH) signal and select overheat protection (Pn61A = n.□□□X).

### 6.13.1 Connecting the Overheat Protection Input (TH) Signal

To use overheat protection, you must connect an overheat protection input (TH) signal to the SERVOPACK. This section describes the connection methods for the overheat protection input (TH) signal.

#### Using Overheat Protection in the Linear Servomotor

- If you use a Serial Converter Unit, connect the connector for the polarity sensor and thermostat cable of the Linear Servomotor to the Serial Converter Unit.
- If you do not use a Serial Converter Unit, connect the thermostat cable of the Linear Servomotor to CN1-33 or CN1-34 on the SERVOPACK.

#### Using Overheat Protection for the Machine

To use overheat protection for the machine, connect the overheat protection input (an analog voltage input) from the sensor mounted to the machine to the CN1-33 or CN1-34 on the SERVOPACK.

### 6.13.2 Overheat Protection Selection

The overheat protection function is selected with Pn61A = n.□□□X (Overheat Protection Selections).

	Parameter	Meaning	When Enabled	Classification
Pn61A	n.□□□0 (default setting)	Disable overheat protection.	After restart	Setup
	n.□□□1	Use overheat protection in the Yaskawa Linear Servomotor.*		
	n.□□□2	Monitor a negative voltage input from a sensor attached to the machine and use overheat protection.		
	n.□□□3	Monitor a positive voltage input from a sensor attached to the machine and use overheat protection.		

\* The SGLFW2 is the only Yaskawa Linear Servomotor that supports this function.

## Using Overheat Protection in the Yaskawa Linear Servomotor

To use the overheat protection in the Yaskawa Linear Servomotor (SGLFW2), set Pn61A to n.□□□1.

An A.93B warning (Overheat Warning) will be detected if the overheat protection input (TH) signal from the Yaskawa SGLFW2 Linear Servomotor exceeds the warning temperature.

An A.862 alarm (Overheat Alarm) will be detected if the overheat protection input (TH) signal from the Yaskawa SGLFW2 Linear Servomotor exceeds the alarm temperature.



Important

- If the overheat protection input signal line is disconnected or short-circuited, an A.862 alarm will occur.
- If you set Pn61A to n.□□□1 (Use overheat protection in the Yaskawa Linear Servomotor), the parameters in the Servomotor are enabled and the following parameters are disabled.
  - Overheat Alarm Level (Pn61B)
  - Overheat Warning Level (Pn61C)
  - Overheat Alarm Filter Time (Pn61D)

## Monitoring the Machine's Temperature and Using Overheat Protection

Set Pn61A = n.□□□X to 2 or 3 to use overheat protection for the machine.

Set the following parameters as required.

Pn61B All Axes	Overheat Alarm Level			Speed	Position	Torque
	Setting Range	Setting Unit	Default Setting	When Enabled	Classification	
	0 to 500	0.01 V	250	Immediately	Setup	
Pn61C All Axes	Overheat Warning Level			Speed	Position	Torque
	Setting Range	Setting Unit	Default Setting	When Enabled	Classification	
	0 to 100	1%	100	Immediately	Setup	
Pn61D All Axes	Overheat Alarm Filter Time			Speed	Position	Torque
	Setting Range	Setting Unit	Default Setting	When Enabled	Classification	
	0 to 65,535	1 s	0	Immediately	Setup	



Important

- When Pn61A is set to n.□□□2, an A.862 alarm will occur if the overheat protection input signal line is disconnected or short-circuited.
- When Pn61A is set to n.□□□3, an A862 alarm will not occur if the overheat protection input signal line is disconnected or short-circuited. To ensure safety, we recommend that you connect the external circuits so that you can use a negative voltage input for the overheat protection input (an analog voltage input).

# Trial Operation and Actual Operation

# 7

This chapter provides information on the flow and procedures for trial operation and convenient functions to use during trial operation.

<b>7.1</b>	<b>Flow of Trial Operation</b> . . . . .	<b>7-2</b>
7.1.1	Flow of Trial Operation for Rotary Servomotors . .	7-2
7.1.2	Flow of Trial Operation for Linear Servomotors . .	7-3
<b>7.2</b>	<b>Inspections and Confirmations before Trial Operation</b> . . .	<b>7-6</b>
<b>7.3</b>	<b>Trial Operation for the Servomotor without a Load</b> . . . . .	<b>7-7</b>
7.3.1	Preparations . . . . .	7-7
7.3.2	Applicable Tools . . . . .	7-8
7.3.3	Operating Procedure . . . . .	7-8
<b>7.4</b>	<b>Trial Operation with MECHATROLINK-III Communications</b> . .	<b>7-10</b>
<b>7.5</b>	<b>Trial Operation with the Servomotor Connected to the Machine</b> . . . .	<b>7-12</b>
7.5.1	Precautions . . . . .	7-12
7.5.2	Preparations . . . . .	7-12
7.5.3	Operating Procedure . . . . .	7-13
<b>7.6</b>	<b>Convenient Function to Use during Trial Operation</b> . . . . .	<b>7-14</b>
7.6.1	Program Jogging . . . . .	7-14
7.6.2	Origin Search . . . . .	7-20
7.6.3	Test without a Motor . . . . .	7-23
<b>7.7</b>	<b>Operation Using MECHATROLINK-III Commands</b> . . . . .	<b>7-26</b>



# 7.1 Flow of Trial Operation

## 7.1.1 Flow of Trial Operation for Rotary Servomotors

The procedure for trial operation is given below.

• Preparations for Trial Operation

Step	Meaning	Reference
1	<b>Installation</b> Install the Servomotor and SERVOPACK according to the installation conditions. First, operation is checked with no load. Do not connect the Servomotor to the machine.	<i>Chapter 3 SERVOPACK Installation</i>
2	<b>Wiring and Connections</b> Wire and connect the SERVOPACK. First, Servomotor operation is checked without a load. Do not connect the CN1 connector on the SERVOPACK.	<i>Chapter 4 Wiring and Connecting SERVOPACKs</i>
3	<b>Confirmations before Trial Operation</b>	<i>7.2 Inspections and Confirmations before Trial Operation on page 7-6</i>
4	<b>Power ON</b>	—
5	<b>Resetting the Absolute Encoder</b> This step is necessary only for a Servomotor with an Absolute Encoder.	<i>5.16 Resetting the Absolute Encoder on page 5-48</i>

• Trial Operation

Step	Meaning	Reference
1	<b>Trial Operation for the Servomotor without a Load</b> 	<i>7.3 Trial Operation for the Servomotor without a Load on page 7-7</i>
2	<b>Trial Operation with MECHATROLINK-III Communications</b> 	<i>7.4 Trial Operation with MECHATROLINK-III Communications on page 7-10</i>

Continued on next page.

Continued from previous page.

Step	Meaning	Reference
3	<p><b>Trial Operation with the Servomotor Connected to the Machine</b></p>	<p>7.5 Trial Operation with the Servomotor Connected to the Machine on page 7-12</p>

## 7.1.2 Flow of Trial Operation for Linear Servomotors

The procedure for trial operation is given below.

• Preparations for Trial Operation

Step	Meaning	Reference
1	<p><b>Installation</b> Install the Servomotor and SERVOPACK according to the installation conditions. First, operation is checked with no load. Do not connect the Servomotor to the machine.</p>	Chapter 3 SERVOPACK Installation
2	<p><b>Wiring and Connections</b> Wire and connect the SERVOPACK. First, Servomotor operation is checked without a load. Do not connect the CN1 connector on the SERVOPACK.</p>	Chapter 4 Wiring and Connecting SERVOPACKs
3	Confirmations before Trial Operation	7.2 Inspections and Confirmations before Trial Operation on page 7-6
4	Power ON	–

**Setting Parameters in the SERVOPACK**

Step	No. of Parameter to Set	Description	Remarks	Reference
5-1	Pn282	Linear Encoder Pitch	Set this parameter only if you are using a Serial Converter Unit.	page 5-17
5-2	–	Writing Parameters to the Linear Servomotor	Set this parameter only if you are not using a Serial Converter Unit.	page 5-18
5-3	Pn080 = n.□□X□	Motor Phase Sequence Selection	–	page 5-22
5-4	Pn080 = n.□□□X	Polarity Sensor Selection	–	page 5-24
5-5	–	Polarity Detection	This step is necessary only for a Linear Servomotor with a Polarity Sensor.	page 5-25
5-6	Pn50A = n.X□□□ and Pn50B = n.□□□X or Pn590 and Pn591	Overtravel Signal Allocations	–	page 5-28
5-7	Pn483, Pn484	Force Control	–	page 6-22

Continued on next page.

7.1 Flow of Trial Operation

7.1.2 Flow of Trial Operation for Linear Servomotors

Continued from previous page.

Step	Meaning	Reference
6	<p>Setting the Origin of the Absolute Linear Encoder</p> <p>This step is necessary only for the following Absolute Linear Encoders.</p> <ul style="list-style-type: none"> <li>• Mitutoyo Corporation ABS ST780A Series or ST1300 Series Models: ABS ST78□A/ST78□AL/ST13□□</li> <li>• Renishaw PLC EVOLUTE Series Models: EL36Y-□□□□□□□□</li> <li>• Renishaw PLC RESOLUTE Series Models: RL36Y-□□□□□□□□</li> </ul>	<p>5.17.2 Setting the Origin of the Absolute Linear Encoder on page 5-51</p>

• Trial Operation

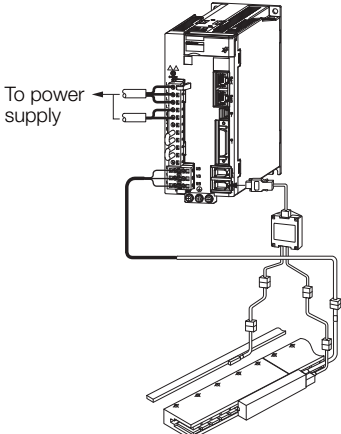
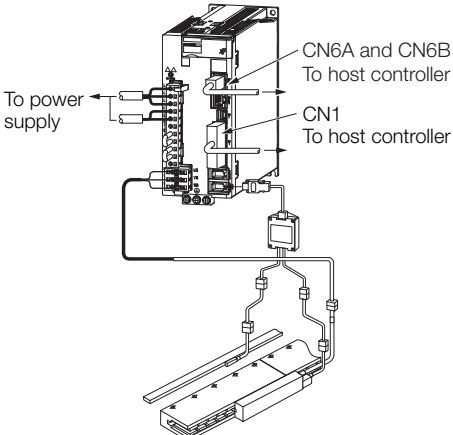
Step	Meaning	Reference
1	<p>Trial Operation for the Servomotor without a Load</p> 	<p>7.3 Trial Operation for the Servomotor without a Load on page 7-7</p>
2	<p>Trial Operation with MECHATROLINK-III Communications</p> 	<p>7.4 Trial Operation with MECHATROLINK-III Communications on page 7-10</p>

Continued on next page.

Continued from previous page.

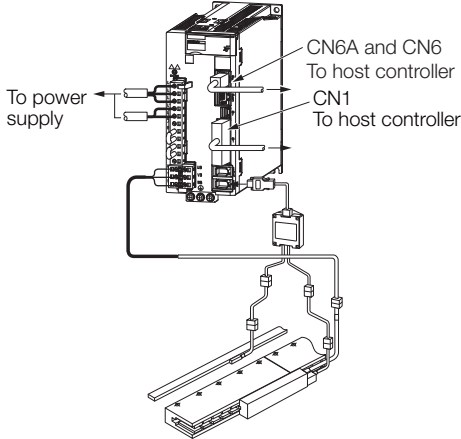
Step	Meaning	Reference
3	<p>Trial Operation with the Servomotor Connected to the Machine</p> 	<p><i>7.5 Trial Operation with the Servomotor Connected to the Machine on page 7-12</i></p>

## 7.2 Inspections and Confirmations before Trial Operation

To ensure safe and correct trial operation, check the following items before you start trial operation.

- Make sure that the SERVOPACK and Servomotor are installed, wired, and connected correctly.
- Make sure that the correct power supply voltage is supplied to the SERVOPACK.
- Make sure that there are no loose parts in the Servomotor mounting.
- If you are using a Servomotor with an Oil Seal, make sure that the oil seal is not damaged. Also make sure that oil has been applied.
- If you are performing trial operation on a Servomotor that has been stored for a long period of time, make sure that all Servomotor inspection and maintenance procedures have been completed.

Refer to the manual for your Servomotor for Servomotor maintenance and inspection information.

- If you are using a Servomotor with a Holding Brake, make sure that the brake is released in advance. To release the brake, you must apply the specified voltage of 24 VDC to the brake. A circuit example for trial operation is provided below.

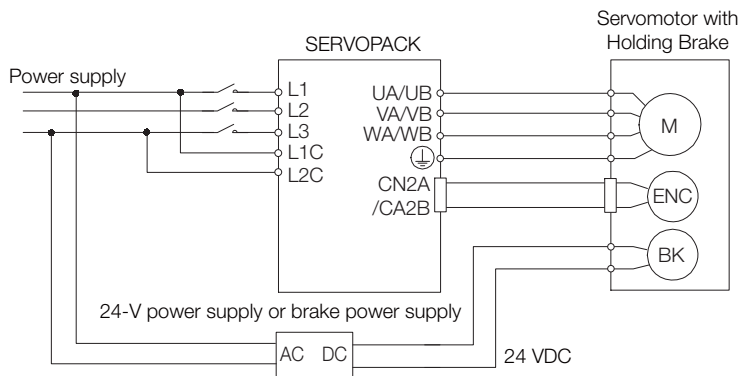

## 7.3

## Trial Operation for the Servomotor without a Load

You use jogging for trial operation of the Servomotor without a load.

Jogging is used to check the operation of the Servomotor without connecting the SERVOPACK to the host controller. The Servomotor is moved at the preset jogging speed.

 **CAUTION**

- During jogging, the overtravel function is disabled. Consider the range of motion of your machine when you jog the Servomotor.



Important

The tuning-less function is enabled as the default setting. When the tuning-less function is enabled, gain will increase and vibration may occur if the Servomotor is operated with no load. If vibration occurs, disable the tuning-less function (Pn170 = n.□□□0).

## 7.3.1 Preparations

Always check the following before you execute jogging.

- The parameters must not be write prohibited.
- The main circuit power supply must be ON.
- There must be no alarms.
- The servo must be OFF.
- The jogging speed must be set considering the operating range of the machine. The jogging speed is set with the following parameters.

- Rotary Servomotors

Pn304	Jogging Speed <span style="float:right">[Speed] [Position] [Torque]</span>				
	Setting Range	Setting Unit	Default Setting	When Enabled	Classification
	0 to 10,000	1 min <sup>-1</sup>	500	Immediately	Setup
Pn305	Soft Start Acceleration Time <span style="float:right">[Speed]</span>				
	Setting Range	Setting Unit	Default Setting	When Enabled	Classification
	0 to 10,000	1 ms	0	Immediately	Setup
Pn306	Soft Start Deceleration Time <span style="float:right">[Speed]</span>				
	Setting Range	Setting Unit	Default Setting	When Enabled	Classification
	0 to 10,000	1 ms	0	Immediately	Setup

- Direct Drive Servomotors



Pn304	Jogging Speed <span style="float:right">[Speed] [Position] [Torque]</span>				
	Setting Range	Setting Unit	Default Setting	When Enabled	Classification
	0 to 10,000	0.1 min <sup>-1</sup>	500	Immediately	Setup
Pn305	Soft Start Acceleration Time <span style="float:right">[Speed]</span>				
	Setting Range	Setting Unit	Default Setting	When Enabled	Classification
	0 to 10,000	1 ms	0	Immediately	Setup
Pn306	Soft Start Deceleration Time <span style="float:right">[Speed]</span>				
	Setting Range	Setting Unit	Default Setting	When Enabled	Classification
	0 to 10,000	1 ms	0	Immediately	Setup

- Linear Servomotors

Pn383	Jogging Speed <span style="float:right">Speed Position Force</span>				
	Setting Range	Setting Unit	Default Setting	When Enabled	Classification
	0 to 10,000	1 mm/s	50	Immediately	Setup
Pn305	Soft Start Acceleration Time <span style="float:right">Speed</span>				
	Setting Range	Setting Unit	Default Setting	When Enabled	Classification
	0 to 10,000	1 ms	0	Immediately	Setup
Pn306	Soft Start Deceleration Time <span style="float:right">Speed</span>				
	Setting Range	Setting Unit	Default Setting	When Enabled	Classification
	0 to 10,000	1 ms	0	Immediately	Setup

## 7.3.2 Applicable Tools

The following table lists the tools that you can use to perform jogging and the applicable tool functions.

Tool	Function	Operating Procedure Reference
Digital Operator	Fn002	 $\Sigma$ -7-Series Digital Operator Operating Manual (Manual No.: SIEP S800001 33)
SigmaWin+	<b>Test Run - Jog</b>	 Operating Procedure on page 7-8

## 7.3.3 Operating Procedure

Use the following procedure to jog the motor.

1. Click the  Servo Drive Button in the workspace of the Main Window of the SigmaWin+.
2. Select **JOG Operation** in the Menu Dialog Box.  
The Jog Operation Dialog Box will be displayed.
3. Read the warnings and then click the **OK** Button.

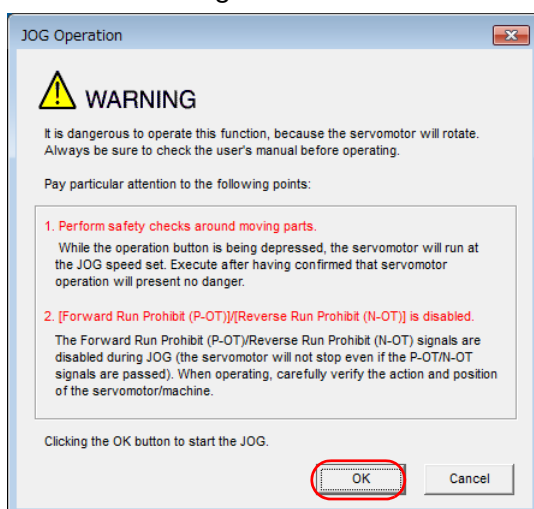

4. Check the jogging speed and then click the **Servo ON** Button.

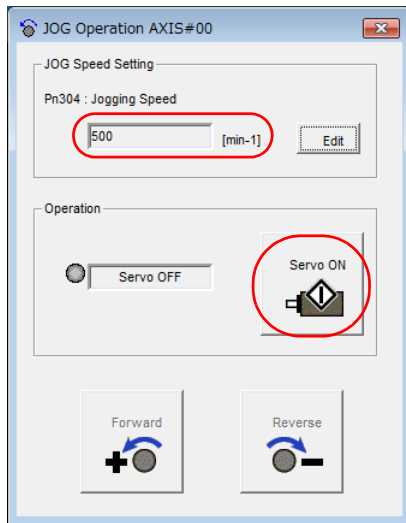

The display in the **Operation** Area will change to **Servo ON**.

**Information** To change the speed, click the **Edit** Button and enter the new speed.

5. Click the **Forward** Button or the **Reverse** Button.  
Jogging will be performed only while you hold down the mouse button.

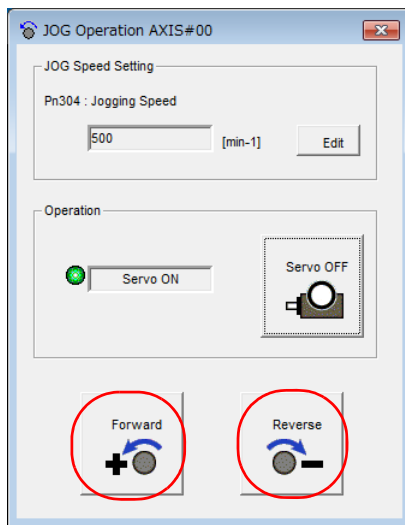

6. After you finish jogging, turn the power supply to the SERVOPACK OFF and ON again.

This concludes the jogging procedure.



# 7.4 Trial Operation with MECHATROLINK-III Communications

A trial operation example for MECHATROLINK-III communications is given below.

Refer to the following manual for command details.

📖  $\Sigma$ -7-Series MECHATROLINK-III Communications Standard Servo Profile Command Manual (Manual No.: SIEP S800001 31)

1. Confirm that the wiring is correct, and then connect the I/O signal connector (CN1 connector).

Refer to the following chapter for details on wiring.

🔗 Chapter 4 Wiring and Connecting SERVOPACKs

2. Turn ON the power supplies to the SERVOPACK and host controller.

If control power is being supplied correctly, the PWR indicator on the SERVOPACK will light.

If main circuit power is being supplied correctly, the CHARGE indicator on the SERVOPACK will light.

If communications are established, the L1 or L2 indicators, whichever one corresponds to the CN6A or CN6B connector where the MECHATROLINK-III Communications Cable (RJ-45) is connected, will light. If the L1 or L2 indicator does not light, recheck the settings of MECHATROLINK-III setting switches (S1, S2, and S3) and then turn the power supply OFF and ON again.

3. Send the CONNECT command from the host controller.

If the SERVOPACK correctly receives the CONNECT command, the CN indicator will light.

If the CN indicator does not light, the settings of the CONNECT command are not correct. Correct the settings of the CONNECT command, and then send it from the host controller again.

4. Confirm the product model with the ID\_RD command.

The SERVOPACK will return the product model (example: SGD7W-1R6A30A).

5. Set the following items, which are necessary for trial operation.

Setting	Reference
Electronic Gear	🔗 5.15 Electronic Gear Settings on page 5-43
Motor Direction	🔗 5.5 Motor Direction Setting on page 5-16
Overtravel	🔗 5.11 Overtravel and Related Settings on page 5-28

6. Save the settings that you made in step 5.

If the settings are saved in the host controller, use the SVPRM\_WR command with the mode set to RAM to save them.

If the settings are saved in the SERVOPACK, use the SVPRM\_WR command with the mode set to non-volatile memory to save them.

7. Send the CONFIG command to enable the settings.

8. Send the SENS\_ON command to obtain the position information (encoder ready).

9. Send the SV\_ON command.

Servomotor operation will be enabled and the SERVOPACK will return 1 for SVON (power supplied to motor) in the status.



10. Operate the Servomotor at low speed.

Operating Example for a Positioning Command

Command: POSING

Command settings: Positioning position = 10,000 (If you are using an absolute encoder, add 10,000 to the present position), rapid traverse speed = 400.

**11. While operation is in progress for step 10, confirm the following items.**

Confirmation Item	Reference
Confirm that the rotational direction of the Servomotor agrees with the forward or reverse reference. If they do not agree, correct the rotation direction of the Servomotor.	 <i>5.5 Motor Direction Setting</i> on page 5-16
Confirm that no abnormal vibration, noise, or temperature rise occurs. If any abnormalities are found, implement corrections.	 <i>10.5 Troubleshooting Based on the Operation and Conditions of the Servomotor</i> on page 10-52

Note: If the load machine is not sufficiently broken in before trial operation, the Servomotor may become overloaded.

## 7.5 Trial Operation with the Servomotor Connected to the Machine

This section provides the procedure for trial operation with both the machine and Servomotor.

### 7.5.1 Precautions

#### WARNING

- Operating mistakes that occur after the Servomotor is connected to the machine may not only damage the machine, but they may also cause accidents resulting in personal injury.



If you disabled the overtravel function for trial operation of the Servomotor without a load, enable the overtravel function (P-OT and N-OT signal) before you perform trial operation with the Servomotor connected to the machine in order to provide protection.

If you will use a holding brake, observe the following precautions during trial operation.

- Before you check the operation of the brake, implement measures to prevent the machine from falling due to gravity and to prevent vibration from being caused by an external force.
- First check the Servomotor operation and brake operation with the Servomotor uncoupled from the machine. If no problems are found, connect the Servomotor to the machine and perform trial operation again.

Control the operation of the brake with the /BK (Brake) signal output from the SERVOPACK.

Refer to the following sections for information on wiring and the related parameter settings.

 4.4.4 *Wiring the SERVOPACK to the Holding Brake* on page 4-31

 5.12 *Holding Brake* on page 5-33



Failures caused by incorrect wiring or incorrect voltage application in the brake circuit may cause the SERVOPACK to fail, damage the SERVOPACK, damage the equipment, or cause an accident resulting in death or injury.



Observe the precautions and instructions for wiring and trial operation precisely as described in this manual.

### 7.5.2 Preparations

Always confirm the following before you perform the trial operation procedure for both the machine and Servomotor.

- Make sure that the procedure described in 7.4 *Trial Operation with MECHATROLINK-III Communications* on page 7-10 has been completed.
- Make sure that the SERVOPACK is connected correctly to both the host controller and the peripheral devices.
  - Overtravel wiring
  - Brake wiring
  - Allocation of the /BK (Brake) signal to a pin on the I/O signal connector (CN1)
  - Emergency stop circuit wiring
  - Host controller wiring

## 7.5.3 Operating Procedure

1. Enable the overtravel signals.  
 5.11.2 *Setting to Enable/Disable Overtravel* on page 5-29
2. Make the settings for the protective functions, such as the overtravel, and the brake.  
 5.11 *Overtravel and Related Settings* on page 5-28  
 5.12 *Holding Brake* on page 5-33
3. Turn OFF the power supply to the SERVOPACK.  
 The control power supply and main circuit power supply will turn OFF.
4. Couple the Servomotor to the machine.

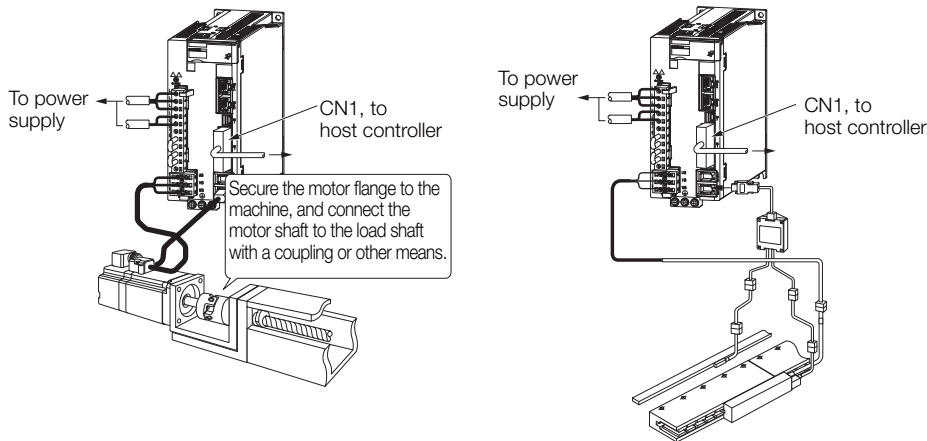

5. Turn ON the power supply to the machine and host controller and turn ON the control power supply and main circuit power supply to the SERVOPACK.
6. Check the protective functions, such as overtravel and the brake, to confirm that they operate correctly.  
 Note: Enable activating an emergency stop so that the Servomotor can be stopped safely should an error occur during the remainder of the procedure.
7. Perform trial operation according to 7.4 *Trial Operation with MECHATROLINK-III Communications* on page 7-10 and confirm that the same results are obtained as when trial operation was performed on the Servomotor without a load.
8. If necessary, adjust the servo gain to improve the Servomotor response characteristics. The Servomotor and machine may not be broken in completely for the trial operation. Therefore, let the system run for a sufficient amount of time to ensure that it is properly broken in.
9. For future maintenance, save the parameter settings with one of the following methods.
  - Use the SigmaWin+ to save the parameters as a file.
  - Record the settings manually.

This concludes the procedure for trial operation with both the machine and Servomotor.

# 7.6 Convenient Function to Use during Trial Operation

This section describes some convenient operations that you can use during trial operation. Use them as required.

## 7.6.1 Program Jogging

You can use program jogging to perform continuous operation with a preset operation pattern, travel distance, movement speed, acceleration/deceleration time, waiting time, and number of movements.

You can use this operation when you set up the system in the same way as for normal jogging to move the Servomotor without connecting it to the host controller in order to check Servomotor operation and execute simple positioning operations.

### Preparations

Always check the following before you execute program jogging.

- The parameters must not be write prohibited.
- The main circuit power supply must be ON.
- There must be no alarms.
- The servo must be OFF.
- The range of machine motion and the safe movement speed of your machine must be considered when you set the travel distance and movement speed.
- There must be no overtravel.

### Additional Information

- You can use the functions that are applicable to position control. However, parameters related to motion control through MECHATROLINK communications (i.e., Pn800 and higher) are disabled.
- The overtravel function is enabled.

### Program Jogging Operation Pattern

An example of a program jogging operation pattern is given below. In this example, the Servomotor direction is set to Pn000 = n.□□□0 (Use CCW as the forward direction).

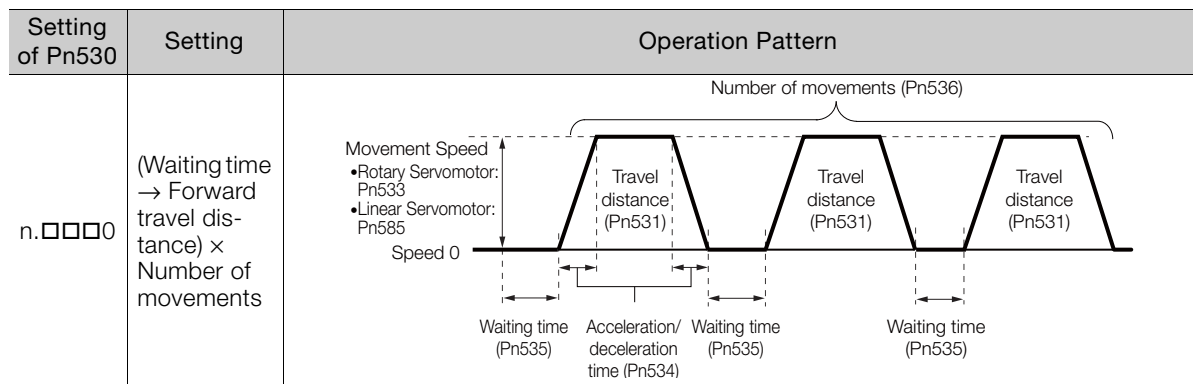

Continued on next page.

Continued from previous page.

Setting of Pn530	Setting	Operation Pattern
n.□□□1	(Waiting time → Reverse by travel distance) × Number of movements	<p>Number of movements (Pn536)</p> <p>Speed 0</p> <p>Movement Speed • Rotary Servomotor: Pn533 • Linear Servomotor: Pn585</p> <p>Travel distance (Pn531)</p> <p>Waiting time (Pn535)</p> <p>Acceleration/deceleration time (Pn534)</p>
n.□□□2	(Waiting time → Forward by travel distance) × Number of movements → (Waiting time → Reverse by travel distance) × Number of movements	<p>Number of movements (Pn536)</p> <p>Speed 0</p> <p>Movement Speed • Rotary Servomotor: Pn533 • Linear Servomotor: Pn585</p> <p>Travel distance (Pn531)</p> <p>Waiting time (Pn535)</p> <p>Acceleration/deceleration time (Pn534)</p>
n.□□□3	(Waiting time → Reverse by travel distance) × Number of movements → (Waiting time → Forward by travel distance) × Number of movements	<p>Number of movements (Pn536)</p> <p>Speed 0</p> <p>Movement Speed • Rotary Servomotor: Pn533 • Linear Servomotor: Pn585</p> <p>Travel distance (Pn531)</p> <p>Waiting time (Pn535)</p> <p>Acceleration/deceleration time (Pn534)</p>
n.□□□4	(Waiting time → Forward by travel distance → Reverse by travel distance) × Number of movements	<p>Number of movements (Pn536)</p> <p>Speed 0</p> <p>Movement Speed • Rotary Servomotor: Pn533 • Linear Servomotor: Pn585</p> <p>Travel distance (Pn531)</p> <p>Waiting time (Pn535)</p> <p>Acceleration/deceleration time (Pn534)</p>
n.□□□5	(Waiting time → Reverse by travel distance → Forward by travel distance) × Number of movements	<p>Number of movements (Pn536)</p> <p>Speed 0</p> <p>Movement Speed • Rotary Servomotor: Pn533 • Linear Servomotor: Pn585</p> <p>Travel distance (Pn531)</p> <p>Waiting time (Pn535)</p> <p>Acceleration/deceleration time (Pn534)</p>

**Information** If Pn530 is set to n.□□□0, n.□□□1, n.□□□4, or n.□□□5, you can set Pn536 (Program Jogging Number of Movements) to 0 to perform infinite time operation. You cannot use infinite time operation if Pn530 is set to n.□□□2 or n.□□□3. If you perform infinite time operation from the Digital Operator, press the **JOG/SVON** Key to turn OFF the servo to end infinite time operation.

## Related Parameters

Use the following parameters to set the program jogging operation pattern. Do not change the settings while the program jogging operation is being executed.

- Rotary Servomotors

Pn530	Program Jogging-Related Selections			Speed	Position	Torque
	Setting Range	Setting Unit	Default Setting	When Enabled	Classification	
	0000 to 0005	–	0000	Immediately	Setup	
Pn531	Program Jogging Travel Distance			Speed	Position	Torque
	Setting Range	Setting Unit	Default Setting	When Enabled	Classification	
	1 to 1,073,741,824	1 reference unit	32,768	Immediately	Setup	
Pn533	Program Jogging Movement Speed			Speed	Position	Torque
	Setting Range	Setting Unit	Default Setting	When Enabled	Classification	
	1 to 10,000	1 min <sup>-1</sup>	500	Immediately	Setup	
Pn534	Program Jogging Acceleration/Deceleration Time			Speed	Position	Torque
	Setting Range	Setting Unit	Default Setting	When Enabled	Classification	
	2 to 10,000	1 ms	100	Immediately	Setup	
Pn535	Program Jogging Waiting Time			Speed	Position	Torque
	Setting Range	Setting Unit	Default Setting	When Enabled	Classification	
	0 to 10,000	1 ms	100	Immediately	Setup	
Pn536	Program Jogging Number of Movements			Speed	Position	Torque
	Setting Range	Setting Unit	Default Setting	When Enabled	Classification	
	0 to 1,000	1	1	Immediately	Setup	

- Direct Drive Servomotors



Pn530	Program Jogging-Related Selections			Speed	Position	Torque
	Setting Range	Setting Unit	Default Setting	When Enabled	Classification	
	0000 to 0005	–	0000	Immediately	Setup	
Pn531	Program Jogging Travel Distance			Speed	Position	Torque
	Setting Range	Setting Unit	Default Setting	When Enabled	Classification	
	1 to 1,073,741,824	1 reference unit	32,768	Immediately	Setup	
Pn533	Program Jogging Movement Speed			Speed	Position	Torque
	Setting Range	Setting Unit	Default Setting	When Enabled	Classification	
	1 to 10,000	0.1 min <sup>-1</sup>	500	Immediately	Setup	
Pn534	Program Jogging Acceleration/Deceleration Time			Speed	Position	Torque
	Setting Range	Setting Unit	Default Setting	When Enabled	Classification	
	2 to 10,000	1 ms	100	Immediately	Setup	
Pn535	Program Jogging Waiting Time			Speed	Position	Torque
	Setting Range	Setting Unit	Default Setting	When Enabled	Classification	
	0 to 10,000	1 ms	100	Immediately	Setup	
Pn536	Program Jogging Number of Movements			Speed	Position	Torque
	Setting Range	Setting Unit	Default Setting	When Enabled	Classification	
	0 to 1,000	1	1	Immediately	Setup	

- Linear Servomotors

Pn530	Program Jogging-Related Selections			Speed	Position	Force
	Setting Range	Setting Unit	Default Setting	When Enabled	Classification	
	0000 to 0005	–	0000	Immediately	Setup	
Pn531	Program Jogging Travel Distance			Speed	Position	Force
	Setting Range	Setting Unit	Default Setting	When Enabled	Classification	
	1 to 1,073,741,824	1 reference unit	32,768	Immediately	Setup	
Pn585	Program Jogging Movement Speed			Speed	Position	Force
	Setting Range	Setting Unit	Default Setting	When Enabled	Classification	
	1 to 10,000	1 mm/s	50	Immediately	Setup	
Pn534	Program Jogging Acceleration/Deceleration Time			Speed	Position	Force
	Setting Range	Setting Unit	Default Setting	When Enabled	Classification	
	2 to 10,000	1 ms	100	Immediately	Setup	
Pn535	Program Jogging Waiting Time			Speed	Position	Force
	Setting Range	Setting Unit	Default Setting	When Enabled	Classification	
	0 to 10,000	1 ms	100	Immediately	Setup	
Pn536	Program Jogging Number of Movements			Speed	Position	Force
	Setting Range	Setting Unit	Default Setting	When Enabled	Classification	
	0 to 1,000	1	1	Immediately	Setup	

## Applicable Tools

The following table lists the tools that you can use to perform program jogging and the applicable tool functions.

Tool	Function	Reference
Digital Operator	Fn004	 $\Sigma$ -7-Series Digital Operator Operating Manual (Manual No.: SIEP S80001 33)
SigmaWin+	<b>Test Run - Program JOG Operation</b>	 Operating Procedure on page 7-18



## Operating Procedure

Use the following procedure for a program jog operation.

1. Click the  Servo Drive Button in the workspace of the Main Window of the SigmaWin+.
2. Select **JOG Program** in the Menu Dialog Box.  
The Jog Program Dialog Box will be displayed.
3. Read the warnings and then click the **OK** Button.

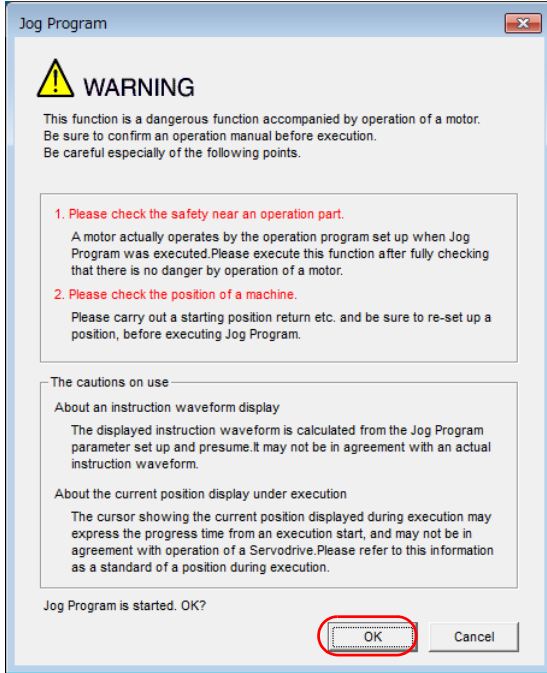

4. Set the operating conditions, click the **Apply** Button, and then click the **Run** Button.  
A graph of the operation pattern will be displayed.

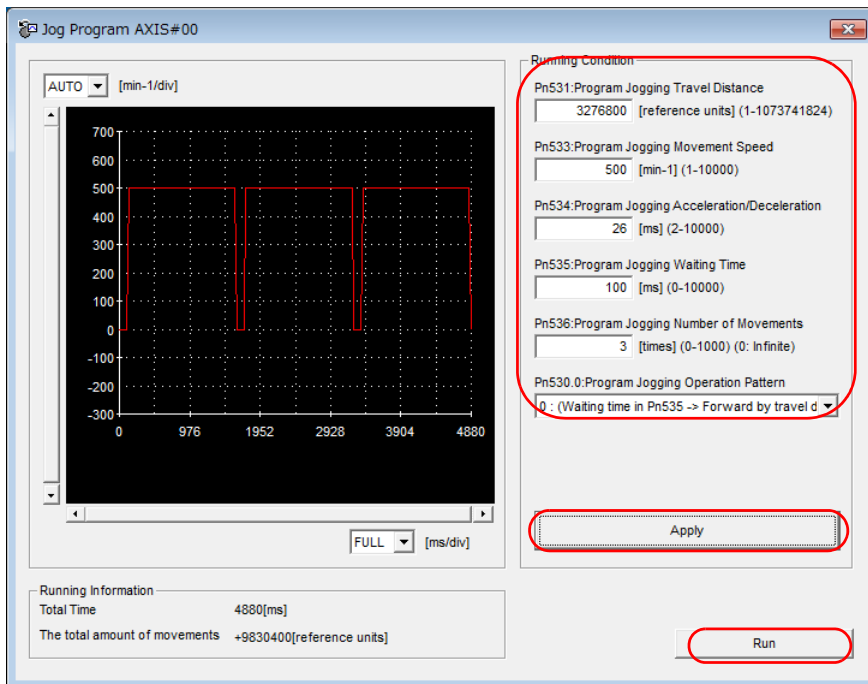

5. Click the **Servo ON** Button and then the **Execute** Button. The program jogging operation will be executed.

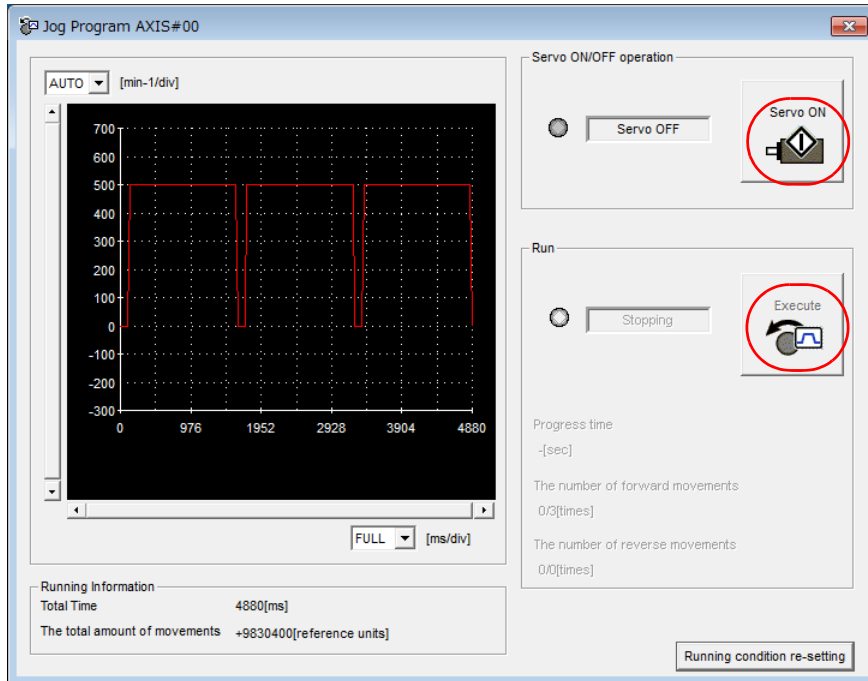

## ⚠ CAUTION

- Be aware of the following points if you cancel the program jogging operation while the Servomotor is operating.
  - If you cancel operation with the **Servo OFF** Button, the Servomotor will stop according to setting of the Servo OFF stopping method (Pn001 = n.□□□X).
  - If you cancel operation with the **Cancel** Button, the Servomotor will decelerate to a stop and then enter a zero-clamped state.

This concludes the program jogging procedure.

## 7.6.2 Origin Search

The origin search operation positions the motor to the origin within one rotation and then clamps it there.

### CAUTION

- Make sure that the load is not coupled when you execute an origin search.  
The Forward Drive Prohibit (P-OT) signal and Reverse Drive Prohibit (N-OT) signal are disabled during an origin search.

Use an origin search when it is necessary to align the origin within one rotation with the machine origin.

- Rotary Servomotors:  $60 \text{ min}^{-1}$
- Direct Drive Servomotors:  $6 \text{ min}^{-1}$
- Linear Servomotors:  $15 \text{ mm/s}$

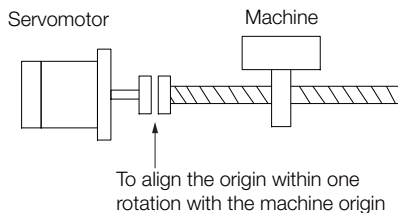

## Preparations

Always check the following before you execute an origin search.

- The parameters must not be write prohibited.
- The main circuit power supply must be ON.
- There must be no alarms.
- The servo must be OFF.

## Applicable Tools

The following table lists the tools that you can use to perform an origin search and the applicable tool functions.

Tool	Function	Reference
Digital Operator	Fn003	📖 $\Sigma$ -7-Series Digital Operator Operating Manual (Manual No.: SIEP S800001 33)
SigmaWin+	Setup - Origin Search	📖 Operating Procedure on page 7-21

## Operating Procedure

Use the following procedure to perform an origin search.

1. Click the  Servo Drive Button in the workspace of the Main Window of the SigmaWin+.
2. Select **Search Origin** in the Menu Dialog Box.  
The Origin Search Dialog Box will be displayed.
3. Read the warnings and then click the **OK** Button.

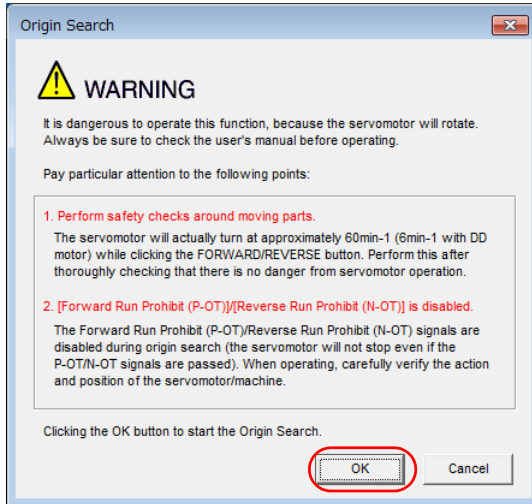

4. Click the **Servo ON** Button.

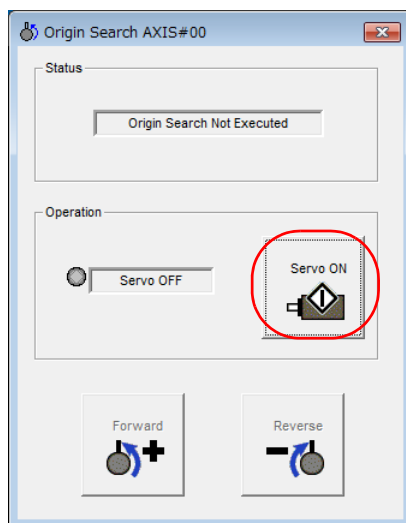

5. Click the **Forward Button** or the **Reverse Button**.

An origin search will be performed only while you hold down the mouse button. The motor will stop when the origin search has been completed.

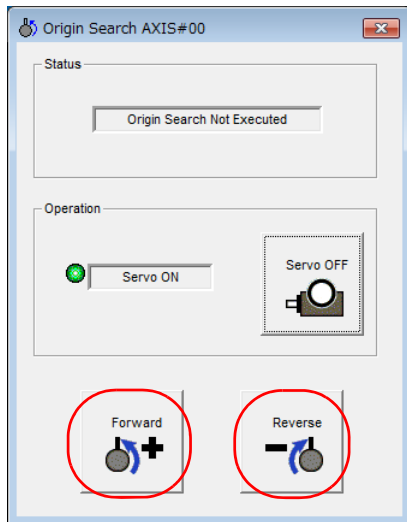

This concludes the origin search procedure.

## 7.6.3 Test without a Motor

A test without a motor is used to check the operation of the host controller and peripheral devices by simulating the operation of the Servomotor in the SERVOPACK, i.e., without actually operating a Servomotor. This test allows you to check wiring, debug the system, and verify parameters to shorten the time required for setup work and to prevent damage to the machine that may result from possible malfunctions. The operation of the Servomotor can be checked with this test regardless of whether the Servomotor is actually connected or not.

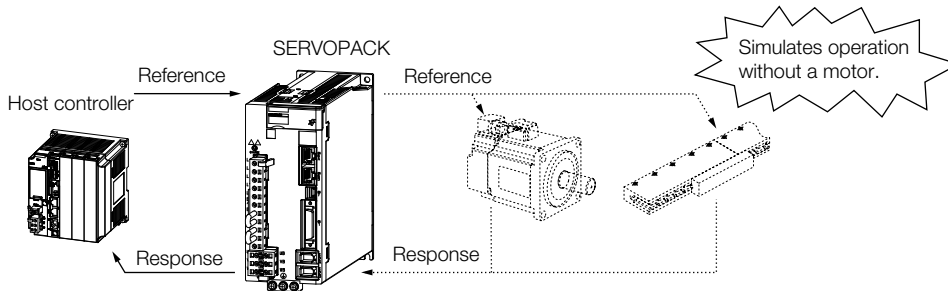

Use Pn00C = n.□□□X to enable or disable the test without a motor.

Parameter	Meaning	When Enabled	Classification
Pn00C	n.□□□0 (default setting)	After restart	Setup
	n.□□□1		

**Information** An asterisk is displayed on the status display of the Digital Operator while a test without a motor is being executed.

## Motor Information and Encoder Information

The motor and encoder information is used during tests without a motor. The source of the information depends on the device connection status.

### • Rotary Servomotor

Motor Connection Status	Information That Is Used	Source of Information
Connected	Motor information • Rated motor speed • Maximum motor speed	Information in the Servomotor that is connected
	Encoder information • Encoder resolution • Encoder type	
Not connected	Motor information • Motor information • Maximum motor speed	<ul style="list-style-type: none"> <li>Setting of Pn000 = n.X□□□ (Rotary/Linear Startup Selection When Encoder Is Not Connected)</li> <li>Rated motor speed and maximum motor speed The values previously saved in the SERVOPACK will be used for the rated motor speed and maximum motor speed.</li> <li>Use the motor displays (Un020: Rated Motor Speed and Un021: Maximum Motor Speed) to check the values.</li> </ul>
	Encoder information • Encoder resolution • Encoder type	<ul style="list-style-type: none"> <li>Encoder resolution: Setting of Pn00C = n.□□X□ (Encoder Resolution for Tests without a Motor)</li> <li>Encoder type: Setting of Pn00C = n.□X□□ (Encoder Type Selection for Tests without a Motor)</li> </ul>

• Linear Servomotors

Motor Connection Status	Information That Is Used	Source of Information
Connected	Motor information	Information in the motor that is connected
	Linear encoder information • Resolution • Encoder pitch • Encoder type	Information in the linear encoder that is connected
Not connected	Motor information	Setting of Pn000 = n.X□□□ (Rotary/Linear Startup Selection When Encoder Is Not Connected)
	Linear encoder information • Resolution • Encoder pitch • Encoder type	• Resolution: 256 • Encoder pitch: Setting of Pn282 (Linear Encoder Pitch) • Encoder type: Setting of Pn00C = n.□X□□ (Encoder Type Selection for Tests without a Motor)

• Related Parameters

Parameter		Meaning	When Enabled	Classification
Pn000	n.0□□□ (default setting)	When an encoder is not connected, start as SERVOPACK for Rotary Servomotor.	After restart	Setup
	n.1□□□	When an encoder is not connected, start as SERVOPACK for Linear Servomotor.		

Pn282	Linear Encoder Pitch				<input type="checkbox"/> Speed	<input type="checkbox"/> Position	<input type="checkbox"/> Force
	Setting Range	Setting Unit	Default Setting	When Enabled	Classification		
	0 to 6,553,600	0.01 μm	0	After restart	Setup		

Parameter		Meaning	When Enabled	Classification
Pn00C	n.□□0□ (default setting)	Use 13 bits as encoder resolution for tests without a motor.	After restart	Setup
	n.□□1□	Use 20 bits as encoder resolution for tests without a motor.		
	n.□□2□	Use 22 bits as encoder resolution for tests without a motor.		
	n.□□3□	Use 24 bits as encoder resolution for tests without a motor.		
	n.□0□□ (default setting)	Use an incremental encoder for tests without a motor.		
	n.□1□□	Use an absolute encoder for tests without a motor.		

### Motor Position and Speed Responses

For a test without a motor, the following responses are simulated for references from the host controller according to the gain settings for position or speed control.

- Servomotor position
- Motor speed

The load model will be for a rigid system with the moment of inertia ratio that is set in Pn103.

## Restrictions

The following functions cannot be used during the test without a motor.

- Regeneration and dynamic brake operation
- Brake output signal
- Items marked with “x” in the following utility function table

Menu Bar Button	SigmaWin+	Digital Operator		Executable?		Reference
	SigmaWin+ Function Name	Fn No.	Utility Function Name	Motor Not Connected	Motor Connected	
Setup	Origin Search	Fn003	Origin Search	○	○	page 7-20
	Absolute Encoder Reset	Fn008	Reset Absolute Encoder	×	○	page 5-49
	Analog Monitor Output Adjustment	Fn00C	Adjust Analog Monitor Output Offset	○	○	page 9-8
		Fn00D	Adjust Analog Monitor Output Gain	○	○	page 9-8
	Motor Current Detection Offset Adjustment	Fn00E	Autotune Motor Current Detection Signal Offset	×	○	page 6-41
		Fn00F	Manually Adjust Motor Current Detection Signal Offset	×	○	
	Parameter Write Prohibition Setting	Fn010	Write Prohibition Setting	○	○	page 5-6
	Multiturn Limit Setting	Fn013	Multiturn Limit Setting after Multiturn Limit Disagreement Alarm	×	○	page 6-30
	Initializing the Vibration Detection Level	Fn01B	Initialize Vibration Detection Level	×	×	page 6-37
	Set Origin	Fn020	Set Absolute Linear Encoder Origin	×	○	page 5-51
	Reset Motor Type Alarm	Fn021	Reset Motor Type Alarm	○	○	–
	Software Reset	Fn030	Software Reset	○	○	page 6-34
	Polarity Detection	Fn080	Polarity Detection	×	×	page 5-25
Tuning-less Level Setting	Fn200	Tuning-less Level Setting	×	×	page 8-16	
Easy FFT	Fn206	Easy FFT	×	×	page 8-97	
Parameter	Initialize *	Fn005	Initialize Parameters	○	○	page 5-9
Tuning	Autotuning without Host Reference	Fn201	Advanced Autotuning without Reference	×	×	page 8-24
	Autotuning with Host Reference	Fn202	Advanced Autotuning with Reference	×	×	page 8-35
	Custom Tuning	Fn203	One-Parameter Tuning	×	×	page 8-43
	Adjust Anti-resonance Control	Fn204	Adjust Anti-resonance Control	×	×	page 8-52
	Vibration Suppression	Fn205	Vibration Suppression	×	×	page 8-57
Monitoring	Product Information	Fn011	Display Servomotor Model	○	○	page 9-2
		Fn012	Display Software Version	○	○	
		Fn01E	Display SERVOPACK and Servomotor IDs	○	○	page 9-2
Test Operation	Jogging	Fn002	Jogging	○	○	page 7-7
	Program Jogging	Fn004	Program Jogging	○	○	page 7-14
Alarms	Alarm Display	Fn000	Display Alarm History	○	○	page 10-39
		Fn006	Clear Alarm History	○	○	page 10-40

\* An **Initialize** Button will be displayed in the Parameter Editing Dialog Box.



## 7.7 Operation Using MECHATROLINK-III Commands

Refer to the following manual for information on MECHATROLINK-III commands.

📖  $\Sigma$ -7-Series MECHATROLINK-III Communications Standard Servo Profile Command Manual (Manual No.: SIEP S800001 31)

**Information** The SERVOPACK's device code is as follows:

ID Code	Description	Data Size	Data Type	Support
02h	Device Code 02250003h ( $\Sigma$ -7W-Series SERVOPACK with RJ-45 Connector (SGD7W-□□□□30□)) There is a specific code for each device.	4 bytes	Binary data	Yes

# Tuning

# 8

This chapter provides information on the flow of tuning, details on tuning functions, and related operating procedures.

<b>8.1</b>	<b>Overview and Flow of Tuning</b>	<b>8-4</b>
8.1.1	Tuning Functions	8-5
8.1.2	Diagnostic Tool	8-6
<b>8.2</b>	<b>Monitoring Methods</b>	<b>8-7</b>
<b>8.3</b>	<b>Precautions to Ensure Safe Tuning</b>	<b>8-8</b>
8.3.1	Overtravel Settings	8-8
8.3.2	Torque Limit Settings	8-8
8.3.3	Setting the Position Deviation Overflow Alarm Level	8-8
8.3.4	Vibration Detection Level Setting	8-10
8.3.5	Setting the Position Deviation Overflow Alarm Level at Servo ON	8-10
<b>8.4</b>	<b>Tuning-less Function</b>	<b>8-12</b>
8.4.1	Application Restrictions	8-12
8.4.2	Operating Procedure	8-13
8.4.3	Troubleshooting Alarms	8-14
8.4.4	Parameters Disabled by Tuning-less Function	8-15
8.4.5	Automatically Adjusted Function Setting	8-15
8.4.6	Related Parameters	8-15
<b>8.5</b>	<b>Estimating the Moment of Inertia</b>	<b>8-16</b>
8.5.1	Outline	8-16
8.5.2	Restrictions	8-16
8.5.3	Applicable Tools	8-17
8.5.4	Operating Procedure	8-17

**8.6 Autotuning without Host Reference . . . . . 8-24**

- 8.6.1 Outline . . . . . 8-24
- 8.6.2 Restrictions . . . . . 8-25
- 8.6.3 Applicable Tools . . . . . 8-26
- 8.6.4 Operating Procedure . . . . . 8-26
- 8.6.5 Troubleshooting Problems in Autotuning  
without a Host Reference . . . . . 8-30
- 8.6.6 Automatically Adjusted Function Settings . . . . . 8-32
- 8.6.7 Related Parameters . . . . . 8-34

**8.7 Autotuning with a Host Reference . . . . . 8-35**

- 8.7.1 Outline . . . . . 8-35
- 8.7.2 Restrictions . . . . . 8-36
- 8.7.3 Applicable Tools . . . . . 8-36
- 8.7.4 Operating Procedure . . . . . 8-37
- 8.7.5 Troubleshooting Problems in Autotuning  
with a Host Reference . . . . . 8-41
- 8.7.6 Automatically Adjusted Function Settings . . . . . 8-41
- 8.7.7 Related Parameters . . . . . 8-42

**8.8 Custom Tuning . . . . . 8-43**

- 8.8.1 Outline . . . . . 8-43
- 8.8.2 Preparations . . . . . 8-43
- 8.8.3 Applicable Tools . . . . . 8-44
- 8.8.4 Operating Procedure . . . . . 8-44
- 8.8.5 Automatically Adjusted Function Settings . . . . . 8-50
- 8.8.6 Tuning Example for Tuning Mode 2 or 3 . . . . . 8-50
- 8.8.7 Related Parameters . . . . . 8-51

**8.9 Anti-Resonance Control Adjustment . . . . . 8-52**

- 8.9.1 Outline . . . . . 8-52
- 8.9.2 Preparations . . . . . 8-52
- 8.9.3 Applicable Tools . . . . . 8-53
- 8.9.4 Operating Procedure . . . . . 8-53
- 8.9.5 Related Parameters . . . . . 8-55
- 8.9.6 Suppressing Different Vibration Frequencies  
with Anti-resonance Control . . . . . 8-55

**8.10 Vibration Suppression . . . . . 8-57**

- 8.10.1 Outline . . . . . 8-57
- 8.10.2 Preparations . . . . . 8-58
- 8.10.3 Applicable Tools . . . . . 8-58
- 8.10.4 Operating Procedure . . . . . 8-59
- 8.10.5 Setting Combined Functions . . . . . 8-61
- 8.10.6 Related Parameters . . . . . 8-61

**8.11 Speed Ripple Compensation . . . . . 8-62**

- 8.11.1 Outline . . . . . 8-62
- 8.11.2 Setting Up Speed Ripple Compensation . . . . . 8-62
- 8.11.3 Setting Parameters . . . . . 8-66

**8.12 Additional Adjustment Functions . . . . . 8-68**

- 8.12.1 Gain Switching . . . . . 8-68
- 8.12.2 Friction Compensation . . . . . 8-72
- 8.12.3 Gravity Compensation . . . . . 8-74
- 8.12.4 Current Control Mode Selection . . . . . 8-75
- 8.12.5 Current Gain Level Setting . . . . . 8-75
- 8.12.6 Speed Detection Method Selection . . . . . 8-76
- 8.12.7 Speed Feedback Filter . . . . . 8-76
- 8.12.8 Backlash Compensation . . . . . 8-76

**8.13 Manual Tuning . . . . . 8-82**

- 8.13.1 Tuning the Servo Gains . . . . . 8-82
- 8.13.2 Compatible Adjustment Functions . . . . . 8-92

**8.14 Diagnostic Tools . . . . . 8-96**

- 8.14.1 Mechanical Analysis . . . . . 8-96
- 8.14.2 Easy FFT . . . . . 8-97

# 8.1 Overview and Flow of Tuning

Tuning is performed to optimize response by adjusting the servo gains in the SERVOPACK.

The servo gains are set using a combination of parameters, such as parameters for the speed loop gain, position loop gain, filters, friction compensation, and moment of inertia ratio. These parameters influence each other, so you must consider the balance between them.

The servo gains are set to stable settings by default. Use the various tuning functions to increase the response even further for the conditions of your machine.

The basic tuning procedure is shown in the following flowchart. Make suitable adjustments considering the conditions and operating requirements of your machine.

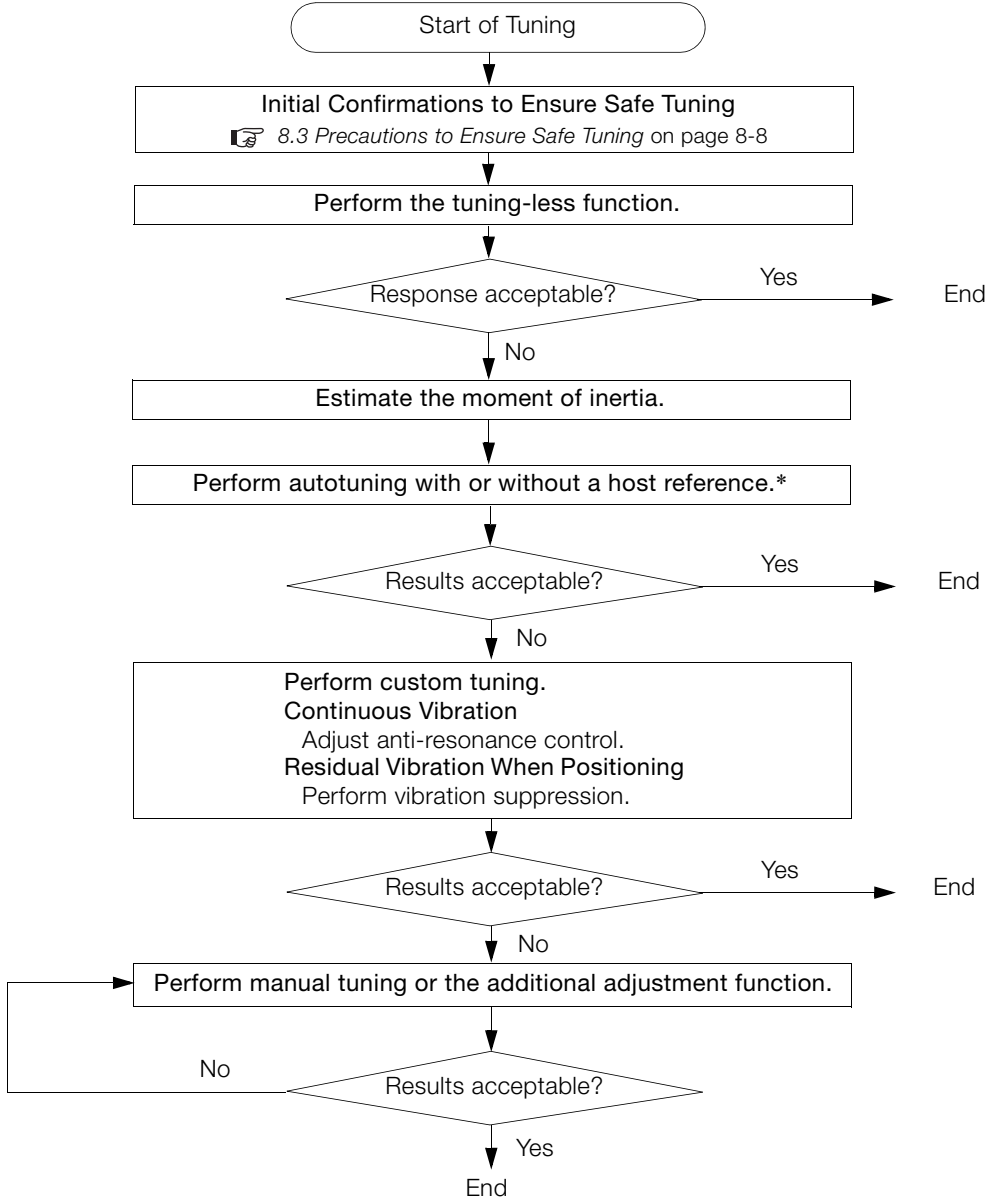

\* If possible, perform autotuning with a host reference.  
 If a host controller is not available, set an operation pattern that is as close as possible to the host reference and perform autotuning without a host reference.  
 If an operation pattern that is close to the host reference is not possible, perform autotuning with a host reference while performing program jogging.

## 8.1.1 Tuning Functions

The following table provides an overview of the tuning functions.

Tuning Function	Outline	Applicable Control Methods	Reference
Tuning-less Function	This automatic adjustment function is designed to enable stable operation without servo tuning. This function can be used to obtain a stable response regardless of the type of machine or changes in the load. You can use it with the default settings.	Speed control or position control	page 8-12
Moment of Inertia Estimation	The moment of inertia ratio is calculated by operating the Servomotor a few times. The moment of inertia ratio that is calculated here is used in other tuning functions.	Speed control, position control, or torque control	page 8-16
Autotuning without Host Reference	The following parameters are automatically adjusted in the internal references in the SERVO-PACK during automatic operation. <ul style="list-style-type: none"> <li>• Gains (e.g., position loop gain and speed loop gain)</li> <li>• Filters (torque reference filter and notch filters)</li> <li>• Friction compensation</li> <li>• Anti-resonance control</li> <li>• Vibration suppression</li> </ul>	Speed control or position control	page 8-24
Autotuning with Host Reference	The following parameters are automatically adjusted with the position reference input from the host controller while the machine is in operation. You can use this function for fine-tuning after you perform autotuning without a host reference. <ul style="list-style-type: none"> <li>• Gains (e.g., position loop gain and speed loop gain)</li> <li>• Filters (torque reference filter and notch filters)</li> <li>• Friction compensation</li> <li>• Anti-resonance control</li> <li>• Vibration suppression</li> </ul>	Position control	page 8-35
Custom Tuning	The following parameters are adjusted with the position reference or speed reference input from the host controller while the machine is in operation. <ul style="list-style-type: none"> <li>• Gains (e.g., position loop gain and speed loop gain)</li> <li>• Filters (torque reference filter and notch filters)</li> <li>• Friction compensation</li> <li>• Anti-resonance control</li> </ul>	Speed control or position control	page 8-43
Anti-resonance Control Adjustment	This function effectively suppresses continuous vibration.	Speed control or position control	page 8-52
Vibration Suppression	This function effectively suppresses residual vibration if it occurs when positioning.	Position control	page 8-57
Speed Ripple Compensation	This function reduces the ripple in the motor speed.	Speed control, position control, or torque control	page 8-62
Additional Adjustment Function	This function combines autotuning with custom tuning. You can use it to improve adjustment results.	Depends on the functions that you use.	page 8-68
Manual Tuning	You can manually adjust the servo gains to adjust the response.	Speed control, position control, or torque control	page 8-82

---

## 8.1.2 Diagnostic Tool

---

You can use the following tools to measure the frequency characteristics of the machine and set notch filters.

Diagnostic Tool	Outline	Applicable Control Methods	Reference
Mechanical Analysis	The machine is subjected to vibration to detect resonance frequencies. The measurement results are displayed as waveforms or numeric data.	Speed control, position control, or torque control	page 8-96
Easy FFT	The machine is subjected to vibration to detect resonance frequencies. The measurement results are displayed only as numeric data.	Speed control, position control, or torque control	page 8-97

## 8.2 Monitoring Methods

You can use the data tracing function of the SigmaWin+ or the analog monitor signals of the SERVOPACK for monitoring. If you perform custom tuning or manual tuning, always use the above functions to monitor the machine operating status and SERVOPACK signal waveform while you adjust the servo gains.

Check the adjustment results with the following response waveforms.

- Position Control

Item	Unit	
	Rotary Servomotor	Linear Servomotor
Torque reference	%	
Feedback speed	min <sup>-1</sup>	mm/s
Position reference speed	min <sup>-1</sup>	mm/s
Position deviation	Reference units	

- Speed Control

Item	Unit	
	Rotary Servomotor	Linear Servomotor
Torque reference	%	
Feedback speed	min <sup>-1</sup>	mm/s
Reference speed	min <sup>-1</sup>	mm/s

- Torque Control

Item	Unit	
	Rotary Servomotor	Linear Servomotor
Torque reference	%	
Feedback speed	min <sup>-1</sup>	mm/s



## 8.3 Precautions to Ensure Safe Tuning

### CAUTION

- Observe the following precautions when you perform tuning.
  - Do not touch the rotating parts of the motor when the servo is ON.
  - Before starting the Servomotor, make sure that an emergency stop can be performed at any time.
  - Make sure that trial operation has been successfully performed without any problems.
  - Provide an appropriate stopping device on the machine to ensure safety.

Perform the following settings in a way that is suitable for tuning.

### 8.3.1 Overtravel Settings

Overtravel settings are made to force the Servomotor to stop for a signal input from a limit switch when a moving part of the machine exceeds the safe movement range.

Refer to the following section for details.

 5.11 *Overtravel and Related Settings* on page 5-28

### 8.3.2 Torque Limit Settings

You can limit the torque that is output by the Servomotor based on calculations of the torque required for machine operation. You can use torque limits to reduce the amount of shock applied to the machine when problems occur, such as collisions or interference. If the torque limit is lower than the torque that is required for operation, overshooting or vibration may occur.

Refer to the following section for details.

 6.6 *Selecting Torque Limits* on page 6-22

### 8.3.3 Setting the Position Deviation Overflow Alarm Level

The position deviation overflow alarm is a protective function that is enabled when the SERVOPACK is used in position control.

If the alarm level is set to a suitable value, the SERVOPACK will detect excessive position deviation and will stop the Servomotor if the Servomotor operation does not agree with the reference.

The position deviation is the difference between the position reference value and the actual position.

You can calculate the position deviation from the position loop gain (Pn102) and the motor speed with the following formula.

- **Rotary Servomotors**

$$\text{Position deviation [reference units]} = \frac{\text{Motor speed [min}^{-1}\text{]}}{60} \times \frac{\text{Encoder resolution}^{*1}}{\text{Pn102 [0.1/s]/10}^{*2, *3}} \times \frac{\text{Pn210}}{\text{Pn20E}}$$

- **Linear Servomotors**

$$\text{Position deviation [reference units]} = \frac{\text{Motor speed [mm/s]}}{\text{Pn102 [0.1/s]/10}^{*2, *3}} \times \frac{\text{Resolution}}{\text{Linear encoder pitch [\mu m]/1,000}} \times \frac{\text{Pn210}}{\text{Pn20E}}$$

Position Deviation Overflow Alarm Level (Pn520) [setting unit: reference units]

#### • Rotary Servomotors

$$Pn520 > \frac{\text{Maximum motor speed [min}^{-1}\text{]}}{60} \times \frac{\text{Encoder resolution}^{*1}}{Pn102 [0.1/s]/10^{*2, *3}} \times \frac{Pn210}{Pn20E} \times \underline{\underline{(1.2 \text{ to } 2)^{*4}}}$$

#### • Linear Servomotors

$$Pn520 > \frac{\text{Maximum motor speed [mm/s]}}{Pn102 [0.1/s]/10^{*2, *3}} \times \frac{\text{Resolution}}{\text{Linear encoder pitch } [\mu\text{m}]/1,000} \times \frac{Pn210}{Pn20E} \times \underline{\underline{(1.2 \text{ to } 2)^{*4}}}$$

\*1. Refer to the following section for details.

 5.15 Electronic Gear Settings on page 5-43

\*2. When model following control (Pn140 = n.□□□1) is enabled, use the setting of Pn141 (Model Following Control Gain) instead of the setting of Pn102 (Position Loop Gain).

\*3. To check the setting of Pn102 on the Digital Operator, change the parameter display setting to display all parameters (Pn00B = n.□□□1).

\*4. The underlined coefficient “× (1.2 to 2)” adds a margin to prevent an A.d00 alarm (Position Deviation Overflow) from occurring too frequently.

If you set a value that satisfies the formula, an A.d00 alarm (Position Deviation Overflow) should not occur during normal operation.

If the Servomotor operation does not agree with the reference, position deviation will occur, an error will be detected, and the Servomotor will stop.

The following calculation example uses a Rotary Servomotor with a maximum motor speed of

6,000 and an encoder resolution of 16,777,216 (24 bits). Pn102 is set to 400.  $\frac{Pn210}{Pn20E} = \frac{1}{16}$

$$\begin{aligned} Pn520 &= \frac{6,000}{60} \times \frac{16,777,216}{400/10} \times \frac{1}{16} \times 2 \\ &= 2,621,440 \times 2 \\ &= 5,242,880 \text{ (default setting of Pn520)} \end{aligned}$$

If the acceleration/deceleration rate required for the position reference exceeds the tracking capacity of the Servomotor, the tracking delay will increase and the position deviation will no longer satisfy the above formulas. If this occurs, lower the acceleration/deceleration rate so that the Servomotor can follow the position reference or increase the position deviation overflow alarm level.

## Related Parameters

Pn520	Position Deviation Overflow Alarm Level <span style="float: right;">Position</span>				
	Setting Range	Setting Unit	Default Setting	When Enabled	Classification
	1 to 1,073,741,823	1 reference unit	5,242,880	Immediately	Setup
Pn51E	Position Deviation Overflow Warning Level <span style="float: right;">Position</span>				
	Setting Range	Setting Unit	Default Setting	When Enabled	Classification
	10 to 100	1%	100	Immediately	Setup

## Related Alarms

Alarm Number	Alarm Name	Alarm Meaning
A.d00	Position Deviation Overflow Alarm	This alarm is displayed when the position deviation exceeds the setting of Pn520 (Position Deviation Overflow Alarm Level).

## Related Warnings

Warning Number	Warning Name	Meaning
A.900	Position Deviation Overflow Warning	This warning occurs if the position deviation exceeds the specified percentage (Pn520 × Pn51E/100).

## 8.3.4 Vibration Detection Level Setting

You can set the vibration detection level (Pn312) to more accurately detect A.520 alarms (Vibration Alarm) and A.911 warnings (Vibration Warning) when vibration is detected during machine operation.

Set the initial vibration detection level to an appropriate value. Refer to the following section for details.

 6.10 *Initializing the Vibration Detection Level* on page 6-37

## 8.3.5 Setting the Position Deviation Overflow Alarm Level at Servo ON

If the servo is turned ON when there is a large position deviation, the Servomotor will attempt to return to the original position to bring the position deviation to 0, which may create a hazardous situation. To prevent this, you can set a position deviation overflow alarm level at servo ON to restrict operation.

The related parameters and alarms are given in the following tables.

### Related Parameters

Pn526	Position Deviation Overflow Alarm Level at Servo ON <span style="float: right;">[Position]</span>				
	Setting Range	Setting Unit	Default Setting	When Enabled	Classification
	1 to 1,073,741,823	1 reference unit	5,242,880	Immediately	Setup

Pn528	Position Deviation Overflow Warning Level at Servo ON <span style="float: right;">[Position]</span>				
	Setting Range	Setting Unit	Default Setting	When Enabled	Classification
	10 to 100	1%	100	Immediately	Setup

#### • Rotary Servomotors

Pn529	Speed Limit Level at Servo ON <span style="float: right;">[Position]</span>				
	Setting Range	Setting Unit	Default Setting	When Enabled	Classification
	0 to 10,000	1 min <sup>-1</sup>	10,000	Immediately	Setup

#### • Linear Servomotors

Pn584	Speed Limit Level at Servo ON <span style="float: right;">[Position]</span>				
	Setting Range	Setting Unit	Default Setting	When Enabled	Classification
	0 to 10,000	1 mm/s	10,000	Immediately	Setup

### Related Alarms

Alarm Number	Alarm Name	Alarm Meaning
A.d01	Position Deviation Overflow Alarm at Servo ON	This alarm occurs if the servo is turned ON after the position deviation exceeded the setting of Pn526 (Excessive Position Deviation Alarm Level at Servo ON) while the servo was OFF.
A.d02	Position Deviation Overflow Alarm for Speed Limit at Servo ON	If position deviation remains in the deviation counter, the setting of Pn529 or Pn584 (Speed Limit Level at Servo ON) will limit the speed when the servo is turned ON. This alarm occurs if a position reference is input and the setting of Pn520 (Excessive Position Deviation Alarm Level) is exceeded.

Refer to the following section for information on troubleshooting alarms.

 10.2.3 *Resetting Alarms* on page 10-38

## Related Warnings

Warning Number	Warning Name	Meaning
A.901	Position Deviation Overflow Warning at Servo ON	This warning occurs if the servo is turned ON while the position deviation exceeds the specified percentage ( $Pn526 \times Pn528/100$ ).

# 8.4 Tuning-less Function

The tuning-less function performs autotuning to obtain a stable response regardless of the type of machine or changes in the load. Autotuning is started when the servo is turned ON.

CAUTION

- The tuning-less function is disabled during torque control.
- The Servomotor may momentarily emit a sound the first time the servo is turned ON after the Servomotor is connected to the machine. This sound is caused by setting the automatic notch filter. It does not indicate a problem. The sound will not be emitted from the next time the servo is turned ON.
- The Servomotor may vibrate if it exceeds the allowable load moment of inertia. If that occurs, set the tuning-less load level to 2 (Pn170 = n.2□□□) or reduce the Tuning-less Rigidity Level (Pn170 = n.□X□□).
- To ensure safety, make sure that you can perform an emergency stop at any time when you execute the tuning-less function.

## 8.4.1 Application Restrictions

The following application restrictions apply to the tuning-less function.

Function	Executable?	Remarks
Vibration Detection Level Initialization	○	-
Moment of Inertia Estimation	×	Disable the tuning-less function (Pn170 = n.□□□0) before you execute moment of inertia estimation.
Autotuning without Host Reference	×	Disable the tuning-less function (Pn170 = n.□□□0) before you execute autotuning without a host reference.
Autotuning with Host Reference	×	-
Custom Tuning	×	-
Anti-Resonance Control Adjustment	×	-
Vibration Suppression	×	-
Easy FFT	○	The tuning-less function is disabled while you execute Easy FFT and then it is enabled when Easy FFT has been completed.
Friction Compensation	×	-
Gain Selection	×	-
Mechanical Analysis	○	The tuning-less function is disabled while you execute mechanical analysis and then it is enabled when mechanical analysis has been completed.

\* ○: Yes x: No

## 8.4.2 Operating Procedure

The tuning-less function is enabled in the default settings. No specific procedure is required. You can use the following parameter to enable or disable the tuning-less function.

Parameter		Meaning	When Enabled	Classification
Pn170	n.□□□0	Disable tuning-less function.	After restart	Setup
	n.□□□1 (default setting)	Enable tuning-less function.		
	n.□□0□ (default setting)	Use for speed control.		
	n.□□1□	Use for speed control and use host controller for position control.		

When you enable the tuning-less function, you can select the tuning-less type. Normally, set Pn14F to n.□□2□ (Use tuning-less type 3) (default setting). If compatibility with previous models is required, set Pn14F to n.□□0□ (Use tuning-less type 1) or n.□□1□ (Use tuning-less type 2).

Parameter		Meaning	When Enabled	Classification
Pn14F	n.□□0□	Use tuning-less type 1.	After restart	Tuning
	n.□□1□	Use tuning-less type 2. (The noise level is improved more than with tuning-less type 1.)		
	n.□□2□ (default setting)	Use tuning-less type 3.		

### Tuning-less Level Settings

If vibration or other problems occur, change the tuning-less levels. To change the tuning-less levels, use the SigmaWin+.

#### ◆ Preparations

Always check the following before you set the tuning-less levels.

- The tuning-less function must be enabled (Pn170 = n.□□□1).
- The test without a motor function must be disabled (Pn00C = n.□□□0).

#### ◆ Procedure

Use the following procedure to set the tuning-less levels.

In addition to the following procedure, you can also set the parameters directly. Refer to *Related Parameters*, below, for the parameters to set.

1. Click the  Servo Drive Button in the workspace of the Main Window of the SigmaWin+.
2. Select **Response Level Setting** in the Menu Dialog Box.  
The Tuning-less Level Setting-Adj Dialog Box will be displayed.

- Click the ▲ or ▼ Button to adjust the tuning-less level setting. Increase the tuning-less level setting to increase the response. Decrease the tuning-less level setting to suppress vibration.

The default response level setting is 4.

Tuning-less Level	Description	Remarks
7	Response level: High	You cannot select these levels if tuning-less type 1 or 2 (Pn14F = n.□□0□ or n.□□1□) is used.
6		
5		
4 (default setting)		
3		
2		
1		
0	Response level: Low	-

- Click the **Completed Button**.

The adjustment results will be saved in the SERVOPACK.

### ◆ Related Parameters

#### ■ Tuning-less Rigidity Level

If you use tuning-less type 1 or 2 (Pn14F = n.□□0□ or n.□□1□), set the tuning-less level to between 0 and 4 (Pn170 = n.□0□□ to n.□4□□). Do not set the tuning-less level to between 5 and 7 (Pn170 = n.□5□□ to n.□7□□).

Parameter	Description	When Enabled	Classification
Pn170	n.□0□□	Immediately	Setup
	n.□1□□		
	n.□2□□		
	n.□3□□		
	n.□4□□ (default setting)		
	n.□5□□		
	n.□6□□		
	n.□7□□		

#### ■ Tuning-less Load Level

Parameter	Description	When Enabled	Classification
Pn170	n.0□□□	Immediately	Setup
	n.1□□□ (default setting)		
	n.2□□□		

## 8.4.3 Troubleshooting Alarms

An A.521 alarm (Autotuning Alarm) will occur if a resonant sound occurs or if excessive vibration occurs during position control. If an alarm occurs, implement the following measures.

- Resonant Sound  
Decrease the setting of Pn170 = n.X□□□ or the setting of Pn170 = n.□X□□.
- Excessive Vibration during Position Control  
Increase the setting of Pn170 = n.X□□□ or decrease the setting of Pn170 = n.□X□□.

## 8.4.4 Parameters Disabled by Tuning-less Function

When the tuning-less function is enabled (Pn170 = n.□□□1) (default setting), the parameters in the following table are disabled.

Item	Parameter Name	Parameter Number
Gain-Related Parameters	Speed Loop Gain	Pn100
	Second Speed Loop Gain	Pn104
	Speed Loop Integral Time Constant	Pn101
	Second Speed Loop Integral Time Constant	Pn105
	Position Loop Gain	Pn102
	Second Position Loop Gain	Pn106
	Moment of Inertia Ratio	Pn103
Advanced Control-Related Parameters	Friction Compensation Function Selection	Pn408 = n.X□□□
	Anti-Resonance Control Selection	Pn160= n.□□□X
Gain Selection-Related Parameters	Gain Switching Selection	Pn139= n.□□□X

The tuning-less function is disabled during torque control, Easy FFT, and mechanical analysis for a vertical axis. The gain-related parameters in the above table are enabled for torque control, Easy FFT, and mechanical analysis. Of these, Pn100, Pn103, and Pn104 are enabled for torque control.

## 8.4.5 Automatically Adjusted Function Setting

You can also automatically adjust notch filters.

Normally, set Pn460 to n.□1□□ (Adjust automatically) (default setting). Vibration is automatically detected and a notch filter is set.

Set Pn460 to n.□0□□ (Do not adjust automatically) only if you do not change the setting of the notch filter before you execute the tuning-less function.

Parameter	Meaning	When Enabled	Classification
Pn460	n.□0□□	Immediately	Tuning
	n.□1□□ (default setting)		

## 8.4.6 Related Parameters

The following parameters are automatically adjusted when you execute the tuning-less function.

Do not manually change the settings of these parameters after you have enabled the tuning-less function.

Parameter	Name
Pn401	First Stage First Torque Reference Filter Time Constant
Pn40C	Second Stage Notch Filter Frequency
Pn40D	Second Stage Notch Filter Q Value



# 8.5 Estimating the Moment of Inertia

This section describes how the moment of inertia is calculated.

The moment of inertia ratio that is calculated here is used in other tuning functions. You can also estimate the moment of inertia during autotuning without a host reference. Refer to the following section for the procedure.

 8.6.4 Operating Procedure on page 8-26

## 8.5.1 Outline

The moment of inertia during operation is automatically calculated by the SERVOPACK for round-trip (forward and reverse) operation. A reference from the host controller is not used.

The moment of inertia ratio (i.e., the ratio of the load moment of inertia to the motor moment of inertia) is a basic parameter for adjusting gains. It must be set as accurately as possible.

Although the load moment of inertia can be calculated from the weight and structure of the mechanisms, doing so is very troublesome and calculating it accurately can be very difficult with the complex mechanical structures that are used these days. With moment of inertia estimation, you can get an accurate load moment of inertia simply by operating the Servomotor in the actual system in forward and reverse a few times.

The Servomotor is operated with the following specifications.

- Maximum speed:  $\pm 1,000 \text{ min}^{-1}$  (can be changed)
- Acceleration rate:  $\pm 20,000 \text{ min}^{-1}/\text{s}$  (can be changed)
- Travel distance:  $\pm 2.5$  rotations max. (can be changed)

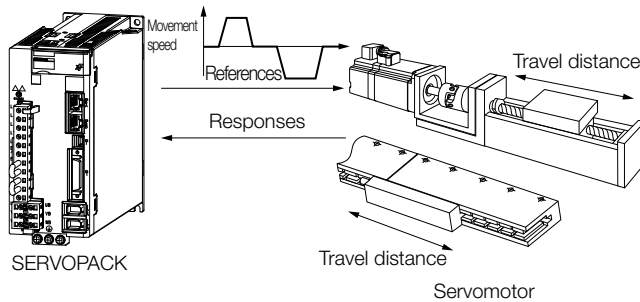

Note: Execute moment of inertia estimation after jogging to a position that ensures a suitable range of motion.

## 8.5.2 Restrictions

The following restrictions apply to estimating the moment of inertia.

### Systems for which Execution Cannot Be Performed

- When the machine system can move only in one direction
- When the range of motion is 0.5 rotations or less

## Systems for Which Adjustments Cannot Be Made Accurately

- When a suitable range of motion is not possible
- When the moment of inertia changes within the set operating range
- When the machine has high dynamic friction
- When the rigidity of the machine is low and vibration occurs when positioning is performed
- When the position integration function is used
- When proportional control is used

Note: If you specify calculating the moment of inertia, an error will occur if V\_PPI in the servo command output signals (SVCMD\_IO) changes to specify the proportional action during moment of inertia estimation.

- When mode switching is used

Note: If you specify moment of inertia estimation, mode switching will be disabled and PI control will be used while the moment of inertia is being calculated. Mode switching will be enabled after moment of inertia estimation has been completed.

- When speed feedforward or torque feedforward is input

## Preparations

Always check the following before you execute moment of inertia estimation.

- The main circuit power supply must be ON.
- There must be no overtravel.
- The servo must be OFF.
- The control method must not be set to torque control.
- The gain selection switch must be set to manual gain selection (Pn139 = n.□□□0).
- The first gains must be selected.
- The test without a motor function must be disabled (Pn00C = n.□□□0).
- There must be no alarms or warnings.
- The parameters must not be write prohibited.
- The tuning-less function must be disabled (Pn170 = n.□□□0).

## 8.5.3 Applicable Tools

The following table lists the tools that you can use to estimate the moment of inertia and the applicable tool functions.

Tool	Function	Operating Procedure Reference
Digital Operator	You cannot estimate the moment of inertia from the Digital Operator.	
SigmaWin+	<i>Tuning - Tuning</i>	 8.5.4 Operating Procedure on page 8-17

## 8.5.4 Operating Procedure

Use the following procedure to estimate the moment of inertia ratio.

### WARNING

- Estimating the moment of inertia requires operating the Servomotor and therefore presents hazards. Observe the following precaution.
  - Confirm safety around moving parts.
 

This function involves automatic operation with vibration. Make sure that you can perform an emergency stop (to turn OFF the power supply) at any time. There will be movement in both directions within the set range of movement. Check the range of movement and the directions and implement protective controls for safety, such as the overtravel functions.

 **CAUTION**

- Be aware of the following points if you cancel the moment of inertia estimation while the Servomotor is operating.
  - If you cancel operation with the **Servo OFF** Button, the Servomotor will stop according to setting of the Servo OFF stopping method (Pn001 = n.□□□X).
  - If you cancel operation with the **Cancel** Button, the Servomotor will decelerate to a stop and then enter a zero-clamped state.

1. Click the  Servo Drive Button in the workspace of the Main Window of the SigmaWin+.
2. Select **Tuning** in the Menu Dialog Box. The Tuning Dialog Box will be displayed. Click the **Cancel** Button to cancel tuning.
3. Click the **Execute** Button.

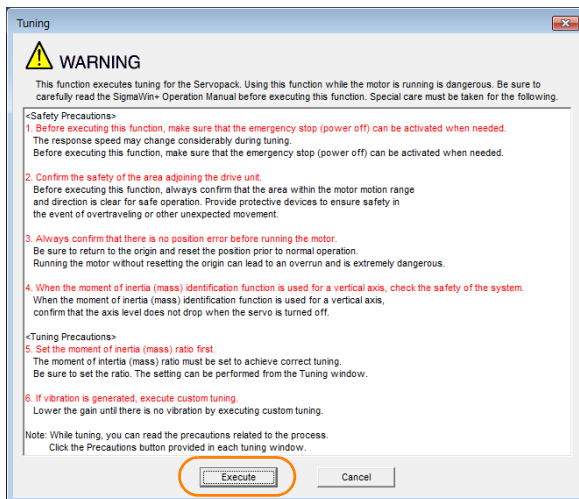

4. Click the **Execute** Button.

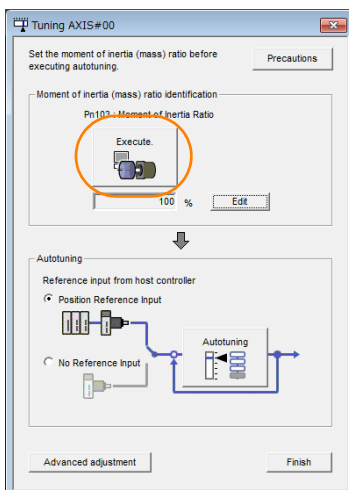

## 5. Set the conditions as required.

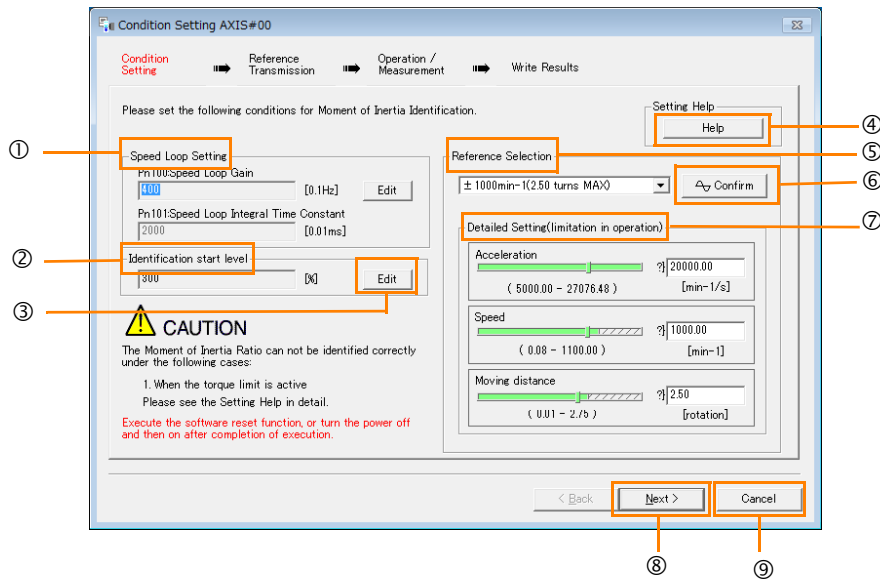
① **Speed Loop Setting Area**

Make the speed loop settings in this area.

If the speed loop response is too bad, it will not be possible to measure the moment of inertia ratio accurately.

The values for the speed loop response that are required for moment of inertia estimation are set for the default settings. It is normally not necessary to change these settings.

If the default speed loop gain is too high for the machine (i.e., if vibration occurs), lower the setting. It is not necessary to increase the setting any farther.

② **Identification Start Level Group**

This is the setting of the moment of inertia calculation starting level.

If the load is large or the machine has low rigidity, the torque limit may be applied, causing moment of inertia estimation to fail.

If that occurs, estimation may be possible if you double the setting of the start level.

③ **Edit Buttons**

Click the button to display a dialog box to change the settings related to the speed loop or estimation start level.

④ **Help Button**

Click this button to display guidelines for setting the reference conditions. Make the following settings as required.

- Operate the Servomotor to measure the load moment of inertia of the machine in comparison with the rotor moment of inertia.
- Set the operation mode, reference pattern (maximum acceleration rate, maximum speed, and maximum travel distance), and speed loop-related parameters.
- Correct measurement of the moment of inertia ratio may not be possible depending on the settings. Set suitable settings using the measurement results as reference.

⑤ **Reference Selection Area**

Either select the reference pattern for estimation processing from the box, or set the values in the **Detailed Setting** Group. Generally speaking, the larger the maximum acceleration rate is, the more accurate the moment of inertia estimation will be.

Set the maximum acceleration range within the possible range of movement considering the gear ratio, e.g., the pulley diameters or ball screw pitch.

⑥ **Confirm** Button

Click this button to display the Reference Confirmation Dialog Box.

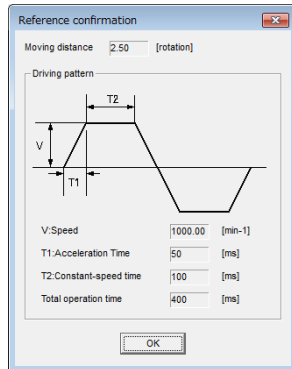
⑦ **Detailed Setting** Area

You can change the settings by moving the bars or directly inputting the settings to create the required reference pattern.

⑧ **Next** Button

Click this button to display the Reference Transmission Dialog Box.

⑨ **Cancel** Button

Click this button to return to the Tuning Dialog Box.

**CAUTION**

- The travel distance is the distance for one operation in the forward or reverse direction. During multiple operations, the operation starting position may move in one direction or the other. Confirm the possible operating range for each measurement or operation.
- Depending on the parameter settings and the moment of inertia of the machine, overshooting and undershooting may occur and may cause the maximum speed setting to be exceeded temporarily. Allow sufficient leeway in the settings.

**Information****When Measurement Is Not Correct**

Estimating the moment of inertia ratio cannot be performed correctly if the torque limit is activated. Adjust the limits or reduce the acceleration rate in the reference selection so that the torque limit is not activated.

**6. Click the Next Button.**

The Reference Transmission Dialog Box will be displayed.

## 7. Click the Start Button.

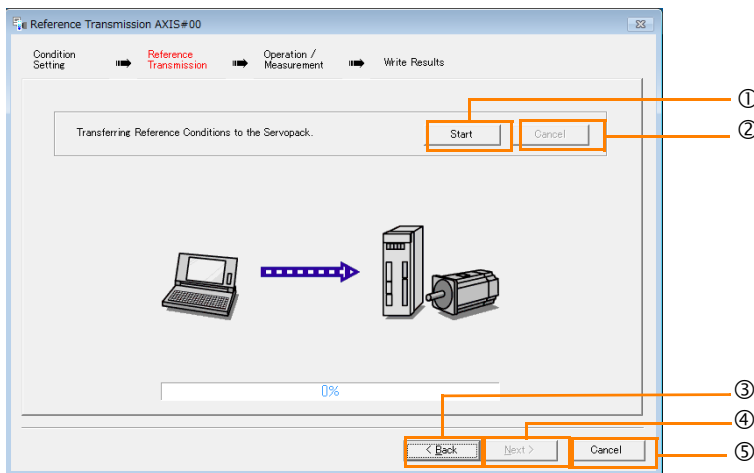

### ① Start Button

The reference conditions will be transferred to the SERVOPACK. A progress bar will show the progress of the transfer.

### ② Cancel Button

The **Cancel** Button is enabled only while data is being transferred to the SERVOPACK. You cannot use it after the transfer has been completed.

### ③ Back Button

This button returns you to the Condition Setting Dialog Box. It is disabled while data is being transferred.

### ④ Next Button

This button is enabled only when the data has been transferred correctly. You cannot use it if an error occurs or if you cancel the transfer before it is completed.

Click the **Next** Button to display the Operation/Measurement Dialog Box.

### ⑤ Cancel Button

This button cancels processing and returns you to the Tuning Dialog Box.

## 8. Click the Next Button.

The Operation/Measurement Dialog Box will be displayed.

## 9. Click the Servo On Button.

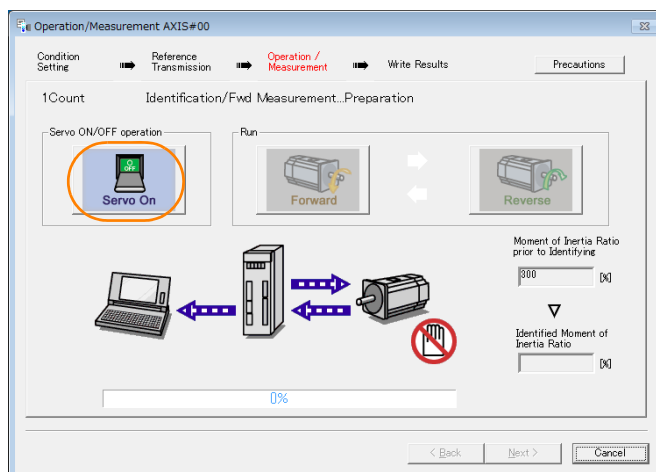

## 10. Click the Forward Button.

The Servomotor shaft will rotate in the forward direction and the measurement will start. After the measurement and data transfer have been completed, the **Reverse** Button will be displayed in color.

11. Click the Reverse Button.

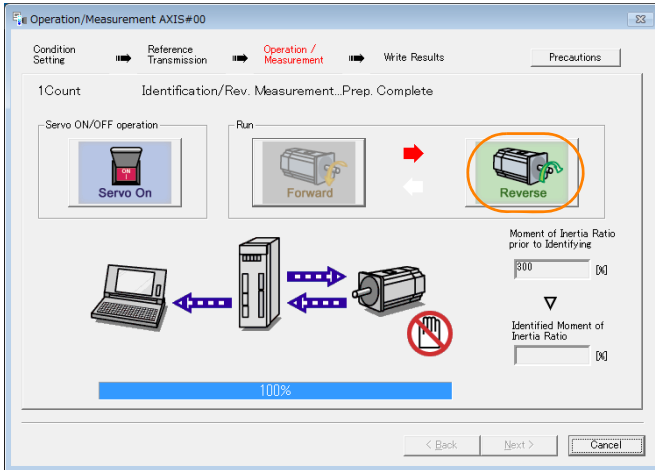

The Servomotor shaft will rotate in the reverse direction and the measurement will start. After the measurement and data transfer have been completed, the **Forward** Button will be displayed in color.

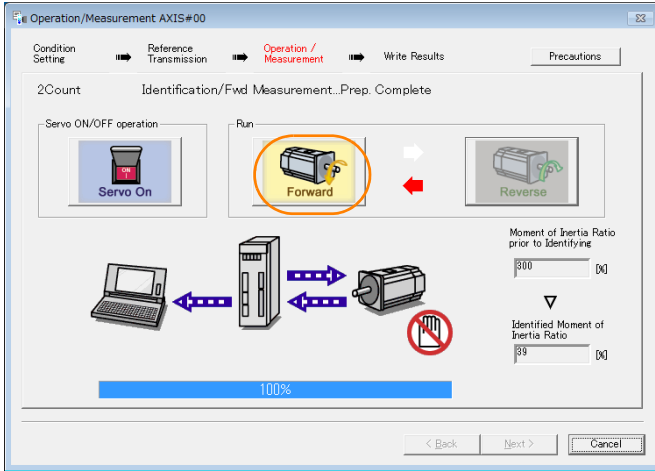

12. Repeat steps 9 to 11 until the Next Button is enabled.

Measurements are performed from 2 to 7 times and then verified. The number of measurements is displayed in upper left corner of the dialog box. A progress bar at the bottom of the dialog box will show the progress of the transfer each time.

13. When the measurements have been completed, click the Servo On Button to turn OFF the servo.

14. Click the Next Button.

The Write Results Dialog Box will be displayed.

**Information** If you click the **Next** Button before you turn OFF the servo, the following Dialog Box will be displayed. Click the **OK** Button to turn OFF the servo.

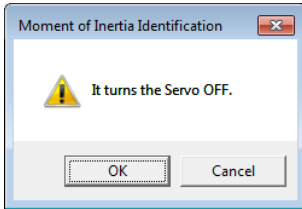

## 15. Click the Writing Results Button.

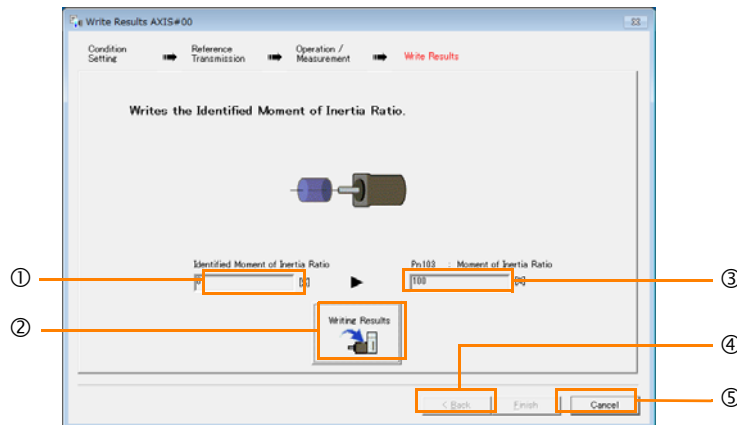

- ① **Identified Moment of Inertia Ratio Box**  
The moment of inertia ratio that was found with operation and measurements is displayed here.
- ② **Writing Results Button**  
If you click this button, Pn103 (Moment of Inertia Ratio) in the SERVOPACK is set to the value that is displayed for the identified moment of inertia ratio.
- ③ **Pn103: Moment of Inertia Ratio Box**  
The value that is set for the parameter is displayed here.  
After you click the **Writing Results** Button, the value that was found with operation and measurements will be displayed as the new setting.
- ④ **Back Button**  
This button is disabled.
- ⑤ **Cancel Button**  
This button will return you to the Tuning Dialog Box.

## 16. Confirm that the Identified Moment of Inertia Ratio Box and the Pn103: Moment of Inertia Ratio Box show the same value and then click the Finish Button.

## 17. Click the OK Button.

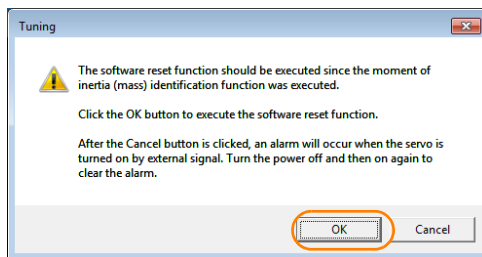

## 18. Click the Execute Button.

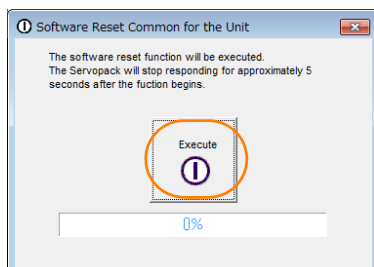

If the setting of the moment of inertia ratio (Pn103) was changed, the new value will be saved and the Tuning Dialog Box will be displayed again.

This concludes the procedure to estimate the moment of inertia ratio.



# 8.6 Autotuning without Host Reference

This section describes autotuning without a host reference.



Important

- Autotuning without a host reference performs adjustments based on the setting of the speed loop gain (Pn100). Therefore, precise adjustments cannot be made if there is vibration when adjustments are started. Make adjustments after lowering the speed loop gain (Pn100) until vibration is eliminated.
- You cannot execute autotuning without a host reference if the tuning-less function is enabled (Pn170 = n.□□□1 (default setting)). Disable the tuning-less function (Pn170 = n.□□□0) before you execute autotuning without a host reference.
- If you change the machine load conditions or drive system after you execute autotuning without a host reference and then you execute autotuning without a host reference with moment of inertia estimation specified, use the following parameter settings. If you execute autotuning without a host reference for any other conditions, the machine may vibrate and may be damaged.
  - Pn140 = n.□□□0 (Do not use model following control.)
  - Pn160 = n.□□□0 (Do not use anti-resonance control.)
  - Pn408 = n.00□0 (Disable friction compensation, first stage notch filter, and second stage notch filter.)

Note: If you are using the Digital Operator and the above parameters are not displayed, change the parameter display setting to display all parameters (Pn00B = n.□□□1) and then turn the power supply OFF and ON again.

## 8.6.1 Outline

For autotuning without a host reference, operation is automatically performed by the SERVO-PACK for round-trip (forward and reverse) operation to adjust for machine characteristics during operation. A reference from the host controller is not used.

The following items are adjusted automatically.

- Moment of inertia ratio
- Gains (e.g., speed loop gain and position loop gain)
- Filters (torque reference filter and notch filters)
- Friction compensation
- Anti-resonance control
- Vibration suppression (only for mode 2 or 3)

Refer to the following section for details on the parameters that are adjusted.

 8.6.7 Related Parameters on page 8-34

The Servomotor is operated with the following specifications.

<b>Maximum speed</b>	Rated motor speed × $\frac{2}{3}$	
<b>Acceleration Torque</b>	Rated motor torque: Approx. 100% Note: The acceleration torque depends on the setting of the moment of inertia ratio (Pn103), and the influences of machine friction and external disturbance.	
<b>Travel Distance</b>	<b>Rotary Servomotors</b>	You can set the desired travel distance. The default setting is for a value equivalent to 3 Servomotor shaft rotations.
	<b>Direct Drive Servomotors</b>	You can set the desired travel distance. The default setting is for a value equivalent to 0.3 rotations.
	<b>Linear Servomotors</b>	You can set the desired travel distance in increments of 1,000 reference units. (The default setting is for 90 mm.)

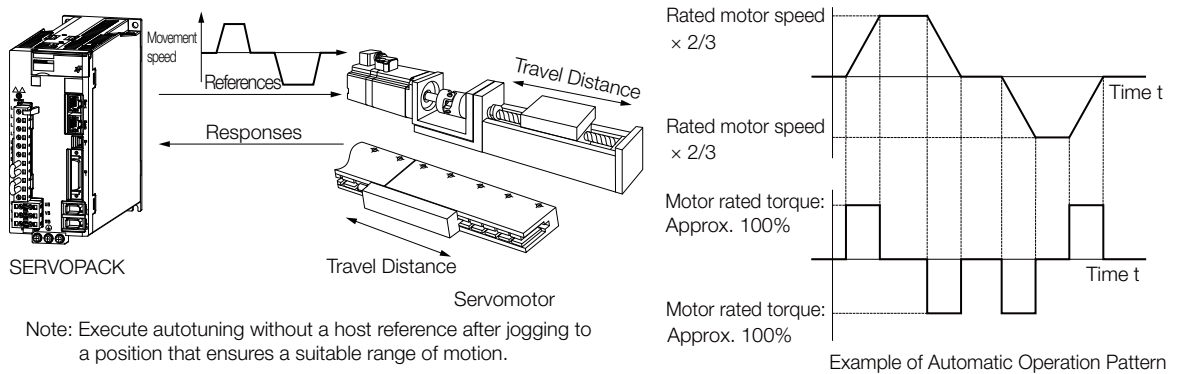

## WARNING

- Autotuning without a host reference requires operating the Servomotor and therefore presents hazards. Observe the following precaution.
  - Confirm safety around moving parts.
    - This function involves automatic operation with vibration. Make sure that you can perform an emergency stop (to turn OFF the power supply) at any time. There will be movement in both directions within the set range of movement. Check the range of movement and the directions and implement protective controls for safety, such as the overtravel functions.

## 8.6.2 Restrictions

The following restrictions apply to autotuning without a host reference.

If you cannot use autotuning without a host reference because of these restrictions, use autotuning with a host reference or custom tuning. Refer to the following sections for details.

☞ 8.7 *Autotuning with a Host Reference* on page 8-35

☞ 8.8 *Custom Tuning* on page 8-43

### Systems for Which Execution Cannot Be Performed

- When the machine system can move only in one direction
- When the range of motion is 0.5 rotations or less

### Systems for Which Adjustments Cannot Be Made Accurately

- When a suitable range of motion is not possible
- When the moment of inertia changes within the set operating range
- When the machine has high friction
- When the rigidity of the machine is low and vibration occurs when positioning is performed
- When the position integration function is used
- When proportional control is used

Note: If you specify calculating the moment of inertia, an error will occur if V\_PPI in the servo command output signals (SVCMD\_IO) changes to specify the proportional action during moment of inertia estimation.

- When mode switching is used

Note: If you specify moment of inertia estimation, mode switching will be disabled and PI control will be used while the moment of inertia is being calculated. Mode switching will be enabled after moment of inertia estimation has been completed.

- When speed feedforward or torque feedforward is input
- When the positioning completed width (Pn522) is too narrow

## Preparations

Always check the following before you execute autotuning without a host reference.



- The main circuit power supply must be ON.
- There must be no overtravel.
- The servo must be OFF.
- The control method must not be set to torque control.
- The gain selection switch must be set to manual gain selection (Pn139 = n.□□□0).
- The first gains must be selected.
- The test without a motor function must be disabled (Pn00C = n.□□□0).
- There must be no alarms or warnings.
- The parameters must not be write prohibited.
- The tuning-less function must be disabled (Pn170 = n.□□□0), or the tuning-less function must be enabled (Pn170 = n.□□□1) (default setting) and moment of inertia estimation must be specified.
- If you execute autotuning without a host reference during speed control, set the mode to 1.

**Information**

- If you start autotuning without a host reference while the SERVOPACK is in speed control for mode 2 or 3, the SERVOPACK will change to position control automatically to perform autotuning without a host reference. The SERVOPACK will return to speed control after autotuning has been completed.

## 8.6.3 Applicable Tools

The following table lists the tools that you can use to perform autotuning without a host reference and the applicable tool functions.

Tool	Function	Operating Procedure Reference
Digital Operator	Fn201	 Σ-7-Series Digital Operator Operating Manual (Manual No.: SIEP S800001 33)
SigmaWin+	<i>Tuning - Tuning</i>	 8.6.4 Operating Procedure on page 8-26

## 8.6.4 Operating Procedure

Use the following procedure to perform autotuning without a host reference.

 **CAUTION**

- If you specify not estimating the moment of inertia, set the moment of inertia ratio (Pn103) correctly. If the setting greatly differs from the actual moment of inertia ratio, normal control of the machine may not be possible, and vibration may result.
- If you are using an MP3000-series Controller for phase control, set the mode selection to 1. If 2 or 3 is selected for the mode, correct phase control may not be possible.

1. Confirm that the moment of inertia ratio (Pn103) is set correctly.
2. Click the  Servo Drive Button in the workspace of the Main Window of the SigmaWin+.
3. Select **Tuning** in the Menu Dialog Box.  
The Tuning Dialog Box will be displayed.  
Click the **Cancel** Button to cancel tuning.

4. Click the Execute Button.

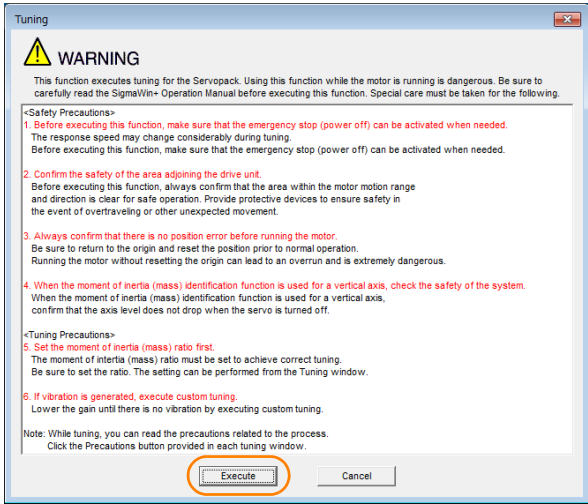

5. Select the No Reference Input Option in the Autotuning Area and then click the Autotuning Button.

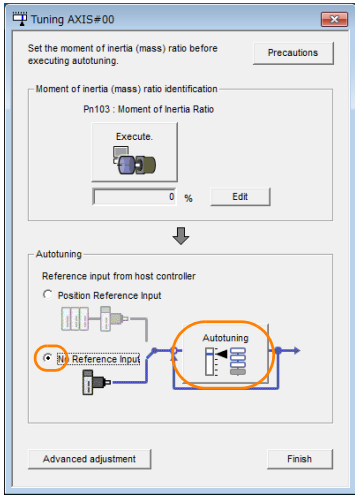

**Information** When the following dialog box is displayed, click the **OK** Button and then confirm that the correct moment of inertia ratio is set in Pn103 (Moment of Inertia Ratio).

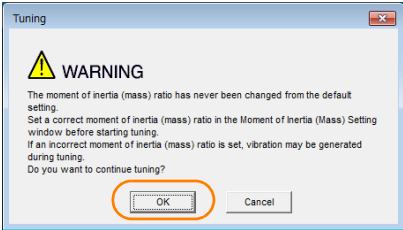

6. Set the conditions in the **Switching the load moment of inertia (load mass) identification Box**, the **Mode selection Box**, the **Mechanism selection Box**, and the **Distance Box**, and then click the **Next Button**.

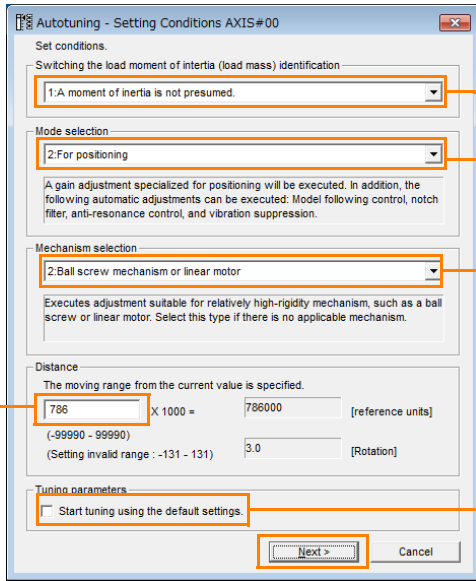

- **Switching the load moment of inertia (load mass) identification Box**  
Specify whether to estimate the moment of inertia.  
0: A moment of inertia is presumed. (default setting)  
1: A moment of inertia is not presumed.

- **Mode selection Box**  
Set the mode.

Mode Selection	Description
1: Standard	Standard gain adjustment is performed. In addition to gain adjustment, notch filters and anti-resonance control are automatically adjusted.
2: For positioning	Tuning is performed for positioning applications. In addition to gain adjustment, model following control, notch filters, anti-resonance control, and vibration suppression are automatically adjusted.
3: For positioning especially to prevent overshooting	Tuning is performed for positioning applications with emphasis on eliminating overshooting. In addition to gain adjustment, notch filters, anti-resonance control, and vibration suppression are automatically adjusted.

- **Distance Box**  
Set the travel distance.  
Movement range: -99,990,000 to +99,990,000 [reference units]  
Minimum setting increment for travel distance: 1,000 [reference units]  
Negative values are for reverse operation and positive values are for forward operation from the current position.  
Default settings:  
Rotary Servomotors: Approx. 3 rotations  
Direct Drive Servomotors: Approx. 0.3 rotations  
Linear Servomotors: Approx 90 mm  
Set the distance to the following values or higher. To ensure tuning precision, we recommend that you use approximately the default distance setting.  
Rotary Servomotors: 0.5 rotations  
Direct Drive Servomotors: 0.05 rotations  
Linear Servomotors: 5 mm

- **Mechanism selection Box**  
Select the type according to the machine element to drive.  
If there is noise or if the gain does not increase, better results may be obtained by changing the rigidity type. Select the type according to the following guidelines.

Mechanism Selection	Description
1: Belt mechanism	Tuning is performed for a mechanism with relatively low rigidity, e.g., a belt.
2: Ball screw mechanism or linear motor	Tuning is performed for a mechanism with relatively high rigidity, e.g., a ball screw or Linear Servomotor. Use this setting if there is no other appropriate setting.
3: Rigid model	Tuning is performed for a mechanism with high rigidity, e.g., a rigid body system.

- **Tuning parameters Box**  
Specify the parameters to use for tuning.  
If you select the **Start tuning using the default settings** Check Box, the tuning parameters will be returned to the default settings before tuning is started.

7. Click the Servo ON Button.

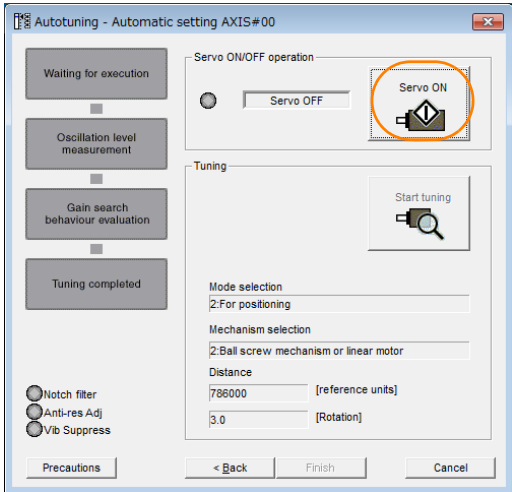

8. Click the Start tuning Button.

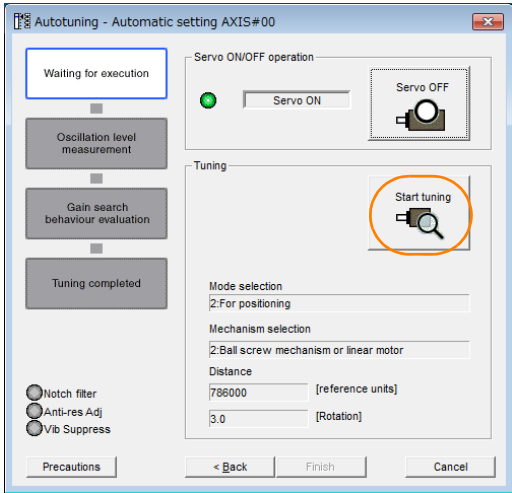

9. Confirm safety around moving parts and click the **Yes** Button.



The Servomotor will start operating and tuning will be executed. Vibration that occurs during tuning will be detected automatically and suitable settings will be made for that vibration. When the settings have been completed, the indicators for the functions that were used will light at the lower left of the dialog box.

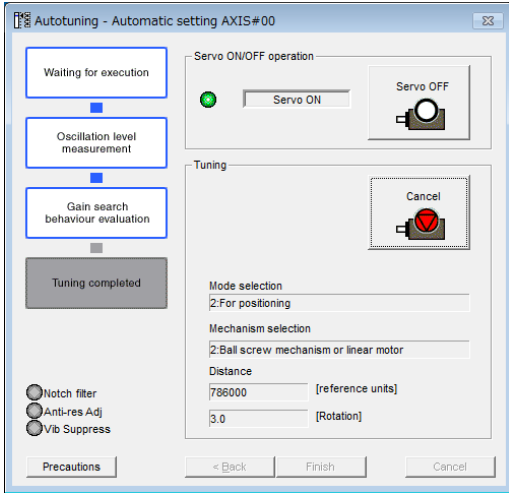

10. When tuning has been completed, click the **Finish** Button.

The results of tuning will be set in the parameters and you will return to the Tuning Dialog Box.

This concludes the procedure to perform autotuning without a host reference.

## 8.6.5 Troubleshooting Problems in Autotuning without a Host Reference

The following tables give the causes of and corrections for problems that may occur in autotuning without a host reference.

### ◆ Autotuning without a Host Reference Was Not Performed

Possible Cause	Corrective Action
Main circuit power supply is OFF.	Turn ON the main circuit power supply.
An alarm or warning occurred.	Remove the cause of the alarm or warning.
Overtraveling occurred.	Remove the cause of overtraveling.
The second gains were selected with the gain selection.	Disable automatic gain switching.
The setting of the travel distance is too small.	Set the travel distance again in step 6 of the procedure.
The settings for the tuning-less function are not correct.	<ul style="list-style-type: none"> <li>Disable the tuning-less function (Pn170 = n.□□□0).</li> <li>Enable the tuning-less function (Pn170 = n.□□□1) and specify moment of inertia estimation.</li> </ul>

### ◆ When an Error Occurs during Execution of Autotuning without a Host Reference

Error	Possible Cause	Corrective Action
The gain adjustments were not successfully completed.	Machine vibration occurs or the positioning completion signal is not stable when the Servomotor stops.	<ul style="list-style-type: none"> <li>• Increase the setting of the positioning completed width (Pn522).</li> <li>• Change the mode from 2 to 3.</li> <li>• If machine vibration occurs, suppress the vibration with the anti-resonance control adjustment and the vibration suppression function.</li> </ul>
An error occurred during calculation of the moment of inertia.	Refer to the following section for troubleshooting information.  ◆ <i>When an Error Occurs during Calculation of Moment of Inertia on page 8-31</i>	
Positioning was not completed within approximately 10 seconds after position adjustment was completed.	The positioning completed width is too narrow or proportional control is being used.	<ul style="list-style-type: none"> <li>• Increase the setting of the positioning completed width (Pn522). Set V_PPI to 0 in the servo command output signals (SVCMD_IO).</li> </ul>

### ◆ When an Error Occurs during Calculation of Moment of Inertia

Possible Cause	Corrective Action
The SERVOPACK started calculating the moment of inertia but the calculation was not completed.	<ul style="list-style-type: none"> <li>• Increase the setting of the speed loop gain (Pn100).</li> <li>• Increase the stroke (travel distance).</li> </ul>
The moment of inertia fluctuated greatly and did not converge within 10 tries.	Set Pn103 (Moment of Inertia Ratio) from the machine specifications and specify not estimating the moment of inertia.
Low-frequency vibration was detected.	Double the setting of moment of inertia calculation starting level (Pn324).
The torque limit was reached.	<ul style="list-style-type: none"> <li>• If you are using the torque limit, increase the torque limit.</li> <li>• Double the setting of moment of inertia calculation starting level (Pn324).</li> </ul>
The speed control section changed to proportional control during calculation of the moment of inertia, e.g., V_PPI in the servo command output signals (SVCMD_IO) was set to 1.	Use PI control when calculating the moment of inertia.

### ◆ Adjustment Results Are Not Satisfactory for Position Control

You may be able to improve the adjustment results by changing the settings of the positioning completed width (Pn522) and the electronic gear (Pn20E/Pn210).

If satisfactory results are still not possible, adjust the overshoot detection level (Pn561). That may improve the adjustment results.

- Pn561 = 100% (default setting)  
This will allow tuning with overshooting that is equivalent to the positioning completed width.
- Pn561 = 0%  
This will allow tuning to be performed without overshooting within the positioning completed width, but the positioning completed width may be extended.

Pn561	Overshoot Detection Level			Speed	Position	Torque
	Setting Range	Setting Unit	Default Setting	When Enabled	Classification	
	0 to 100	1%	100	Immediately	Setup	



## 8.6.6 Automatically Adjusted Function Settings

You can specify whether to automatically adjust the following functions during autotuning.

### ◆ Automatic Notch Filters

Normally, set Pn460 to n.□1□□ (Adjust automatically) (default setting).

Vibration will be detected during autotuning without a host reference and a notch filter will be adjusted.

Set Pn460 to n.□0□□ (Do not adjust automatically) only if you do not change the setting of the notch filter before you execute this function.

Parameter		Function	When Enabled	Classification
Pn460	n.□□□0	Do not adjust the first stage notch filter automatically during execution of autotuning without a host reference, autotuning with a host reference, and custom tuning.	Immediately	Tuning
	n.□□□1 (default setting)	Adjust the first stage notch filter automatically during execution of autotuning without a host reference, autotuning with a host reference, and custom tuning.		
	n.□0□□	Do not adjust the second stage notch filter automatically when the tuning-less function is enabled or during execution of autotuning without a host reference, autotuning with a host reference, and custom tuning.		
	n.□1□□ (default setting)	Adjust the second stage notch filter automatically when the tuning-less function is enabled or during execution of autotuning without a host reference, autotuning with a host reference, and custom tuning.		

### ◆ Anti-Resonance Control Adjustment

This function reduces low vibration frequencies, for which the notch filters cannot be used.

Normally, set Pn160 to n.□□1□ (Adjust automatically) (default setting).

Vibration will be detected during autotuning without a host reference and anti-resonance control will be automatically adjusted.

Parameter		Function	When Enabled	Classification
Pn160	n.□□0□	Do not adjust anti-resonance control automatically during execution of autotuning without a host reference, autotuning with a host reference, and custom tuning.	Immediately	Tuning
	n.□□1□ (default setting)	Adjust anti-resonance control automatically during execution of autotuning without a host reference, autotuning with a host reference, and custom tuning.		

### ◆ Vibration Suppression

You can use vibration suppression to suppress transitional vibration at a low frequency from 1 Hz to 100 Hz, which is generated mainly when the machine vibrates during positioning.

Normally, set Pn140 to n.□1□□ (Adjust automatically) (default setting).

Vibration will be detected during autotuning without a host reference and vibration suppression control will be automatically set.

Set Pn140 = n.□0□□ (Do not adjust automatically) only if you do not change the settings for vibration suppression before you execute autotuning without a host reference.

Note: Autotuning without a host reference uses model following control. Therefore, it can be executed only if the mode is set to 2 or 3.

Parameter		Function	When Enabled	Classification
Pn140	n.0000	Do not adjust vibration suppression automatically during execution of autotuning without a host reference, autotuning with a host reference, and custom tuning.	Immediately	Tuning
	n.1000 (default setting)	Adjust vibration suppression automatically during execution of autotuning without a host reference, autotuning with a host reference, and custom tuning.		

◆ Friction Compensation

Friction compensation compensates for changes in the following conditions.

- Changes in the viscous resistance of the lubricant, such as grease, on the sliding parts of the machine
- Changes in the friction resistance resulting from variations in the machine assembly
- Changes in the friction resistance due to aging

The conditions for applying friction compensation depend on the mode selection.

Mode Selection Settings	Friction Compensation
1: Standard	Based on the setting of Pn408 = n.X000 (Friction Compensation Function Selection)*
2: For position control	Adjusted with friction compensation.
3: For position control (emphasis on overshooting)	

Parameter		Function	When Enabled	Classification
Pn408	n.0000 (default setting)	Disable friction compensation.	Immediately	Setup
	n.1000	Enable friction compensation.		

\* Refer to the following section for details.

Required Parameter Settings on page 8-72

◆ Feedforward

If Pn140 is set to n.0000 (Do not use model following control and speed/torque feedforward together (default setting)) and tuning is performed with the mode selection set to 2 or 3, feedforward (Pn109), the speed feedforward input (VFF), and the torque feedforward input (TFF) will be disabled.

To use the speed feedforward input (VFF), the torque feedforward input (TFF), and model following control from the host controller in the system, set Pn140 to n.1000 (Use model following control and speed/torque feedforward together).

Parameter		Function	When Enabled	Classification
Pn140	n.0000 (default setting)	Do not use model following control and speed/torque feedforward together.	Immediately	Tuning
	n.1000	Use model following control and speed/torque feedforward together.		

Refer to the following manual for information on the torque feedforward input (TFF) and the speed feedforward input (VFF).

Σ-7-Series MECHATROLINK-III Communications Standard Servo Profile Command Manual (Manual No.: SIEP S800001 31)

**Important** When model following control is used with the feedforward function, it is used to make optimum feedforward settings in the SERVOPACK. Therefore, model following control is not normally used together with either the speed feedforward input (VFF) or torque feedforward input (TFF) from the host controller. However, model following control can be used with the speed feedforward input (VFF) or torque feedforward input (TFF) if required. An unsuitable feedforward input may result in overshooting.

## 8.6.7 Related Parameters

The following parameters are automatically adjusted or used as reference when you execute autotuning without a host reference.

Do not change the settings while autotuning without a host reference is being executed.

Parameter	Name	Automatic Changes
Pn100	Speed Loop Gain	Yes
Pn101	Speed Loop Integral Time Constant	Yes
Pn102	Position Loop Gain	Yes
Pn103	Moment of Inertia Ratio	Yes
Pn121	Friction Compensation Gain	Yes
Pn123	Friction Compensation Coefficient	Yes
Pn124	Friction Compensation Frequency Correction	No
Pn125	Friction Compensation Gain Correction	Yes
Pn401	First Stage First Torque Reference Filter Time Constant	Yes
Pn408	Torque-Related Function Selections	Yes
Pn409	First Stage Notch Filter Frequency	Yes
Pn40A	First Stage Notch Filter Q Value	Yes
Pn40C	Second Stage Notch Filter Frequency	Yes
Pn40D	Second Stage Notch Filter Q Value	Yes
Pn140	Model Following Control-Related Selections	Yes
Pn141	Model Following Control Gain	Yes
Pn142	Model Following Control Gain Correction	Yes
Pn143	Model Following Control Bias in the Forward Direction	Yes
Pn144	Model Following Control Bias in the Reverse Direction	Yes
Pn145	Vibration Suppression 1 Frequency A	Yes
Pn146	Vibration Suppression 1 Frequency B	Yes
Pn147	Model Following Control Speed Feedforward Compensation	Yes
Pn160	Anti-Resonance Control-Related Selections	Yes
Pn161	Anti-Resonance Frequency	Yes
Pn163	Anti-Resonance Damping Gain	Yes
Pn531	Program Jogging Travel Distance	No
Pn533	Program Jogging Movement Speed for Rotary Servomotor	No
Pn585	Program Jogging Movement Speed for Linear Servomotor	No
Pn534	Program Jogging Acceleration/Deceleration Time	No
Pn535	Program Jogging Waiting Time	No
Pn536	Program Jogging Number of Movements	No

Yes: The parameter is automatically set.

No: The parameter is not automatically set, but the setting is read during execution.

## 8.7 Autotuning with a Host Reference

This section describes autotuning with a host reference.



Autotuning with a host reference makes adjustments based on the set speed loop gain (Pn100). Therefore, precise adjustments cannot be made if there is vibration when adjustments are started. Make adjustments after lowering the speed loop gain (Pn100) until vibration is eliminated.

### 8.7.1 Outline

Autotuning with a host reference automatically makes optimum adjustments for operation references from the host controller.

The following items are adjusted automatically.

- Gains (e.g., speed loop gain and position loop gain)
- Filters (torque reference filter and notch filters)
- Friction compensation
- Anti-resonance control
- Vibration suppression

Refer to the following section for details on the parameters that are adjusted.

[8.7.7 Related Parameters](#) on page 8-42

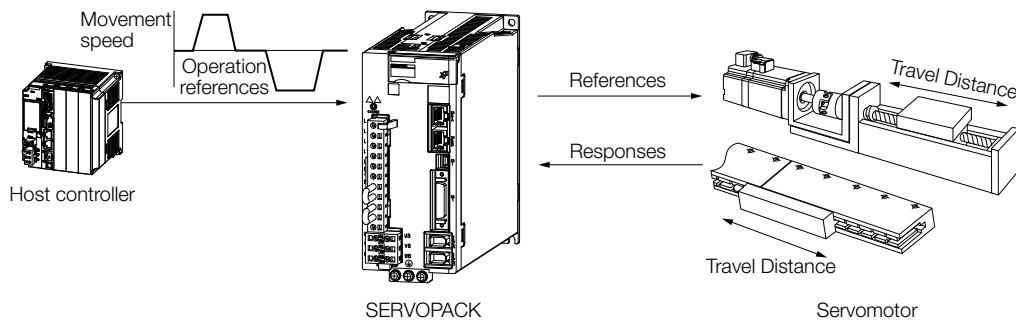

### CAUTION

- Because autotuning with a host reference adjusts the SERVOPACK during automatic operation, vibration or overshooting may occur. To ensure safety, make sure that you can perform an emergency stop at any time.

## 8.7.2 Restrictions

### Systems for Which Adjustments Cannot Be Made Accurately

Adjustments will not be made correctly for autotuning with a host reference in the following cases. Use custom tuning.

- When the travel distance for the reference from the host controller is equal to or lower than the setting of the positioning completed width (Pn522)
- Rotary Servomotors: When the movement speed for the reference from the host controller is equal to or lower than the setting of the rotation detection level (Pn502)
- Linear Servomotors: When the movement speed for the reference from the host controller is equal to or lower than the setting of the zero speed level (Pn581)
- When the time required to stop is 10 ms or less
- When the rigidity of the machine is low and vibration occurs when positioning is performed
- When the position integration function is used
- When proportional control is used
- When mode switching is used
- When the positioning completed width (Pn522) is too narrow

Refer to the following sections for details on custom tuning.

 8.8 Custom Tuning on page 8-43



### Preparations

Always check the following before you execute autotuning with a host reference.

- The servo must be in ready status.
- There must be no overtravel.
- The servo must be OFF.
- Position control must be selected if power is supplied to the motor (i.e., when the servo is ON).
- The gain selection switch must be set to manual gain selection (Pn139 = n.□□□0).
- The first gains must be selected.
- The test without a motor function must be disabled (Pn00C = n.□□□0).
- There must be no warnings.
- The tuning-less function must be disabled (Pn170 = n.□□□0).
- The parameters must not be write prohibited.

## 8.7.3 Applicable Tools

The following table lists the tools that you can use to perform autotuning with a host reference and the applicable tool functions.

Tool	Function	Operating Procedure Reference
Digital Operator	Fn202	 Σ-7-Series Digital Operator Operating Manual (Manual No.: SIEP S800001 33)
SigmaWin+	<b>Tuning - Tuning</b>	 8.7.4 Operating Procedure on page 8-37

## 8.7.4 Operating Procedure

Use the following procedure to perform autotuning with a host reference.

### CAUTION

- If you are using an MP3000-Series Controller for phase control, set the mode selection to 1. If 2 or 3 is selected for the mode, correct phase control may not be possible.

1. Confirm that the moment of inertia ratio (Pn103) is set correctly.
2. Click the  Servo Drive Button in the workspace of the Main Window of the SigmaWin+.
3. Select **Tuning** in the Menu Dialog Box. The Tuning Dialog Box will be displayed. Click the **Cancel** Button to cancel tuning.
4. Click the **Execute** Button.

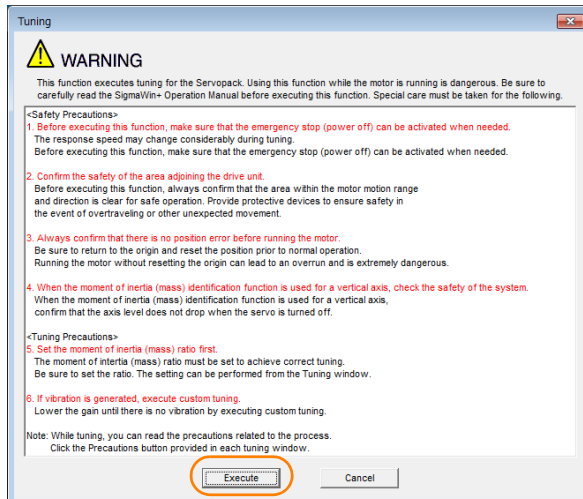

5. Select the **Position reference input** Option in the **Autotuning** Area and then click the **Autotuning** Button.

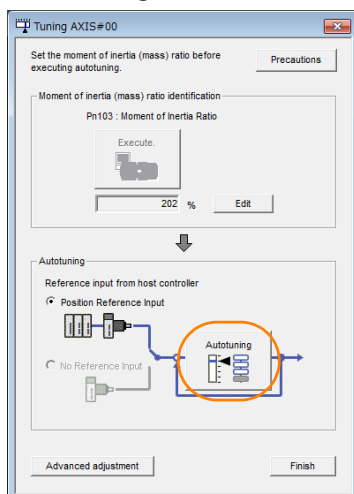

**Information**

When the following dialog box is displayed, click the **OK** Button and then confirm that the correct moment of inertia ratio is set in Pn103 (Moment of Inertia Ratio).

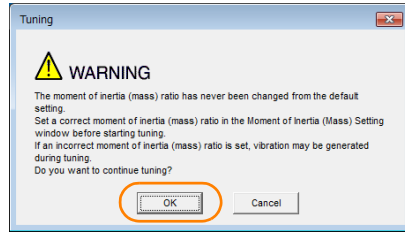

**6. Set the conditions in the Mode selection Box and the Mechanism selection Box, and then click the Next Button.**

If you select the **Start tuning using the default settings** Check Box in the **Tuning parameters** Area, the tuning parameters will be returned to the default settings before tuning is started.

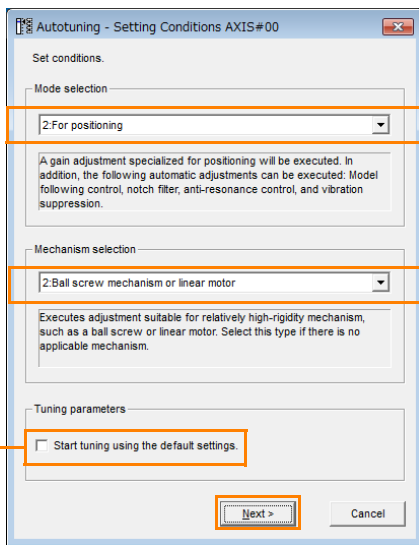

**• Mode selection Box**

Set the mode.

Mode Selection	Description
1: Standard	Standard gain adjustment is performed. In addition to gain adjustment, notch filters and anti-resonance control are automatically adjusted.
2: For positioning	Tuning is performed for positioning applications. In addition to gain adjustment, model following control, notch filters, anti-resonance control, and vibration suppression are automatically adjusted.
3: For positioning especially to prevent overshooting	Tuning is performed for positioning applications with emphasis on eliminating overshooting. In addition to gain adjustment, notch filters, anti-resonance control, and vibration suppression are automatically adjusted.

**• Tuning parameters Box**

Specify the parameters to use for tuning. If you select the **Start tuning using the default settings** Check Box, the tuning parameters will be returned to the default settings before tuning is started.

**• Mechanism selection Box**

Select the type according to the machine element to drive. If there is noise or if the gain does not increase, better results may be obtained by changing the rigidity type. Select the type according to the following guidelines.

Mechanism Selection	Description
1: Belt mechanism	Tuning is performed for a mechanism with relatively low rigidity, e.g., a belt.
2: Ball screw mechanism or linear motor	Tuning is performed for a mechanism with relatively high rigidity, e.g., a ball screw or Linear Servomotor. Use this setting if there is no other appropriate setting.
3: Rigid model	Tuning is performed for a mechanism with high rigidity, e.g., a rigid body system.

## 7. Click the Yes Button.

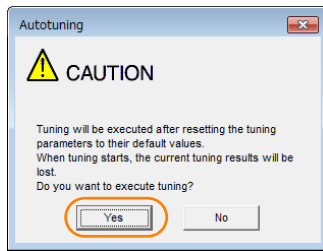

## 8. Input the correct moment of inertia ratio and click the Next Button.

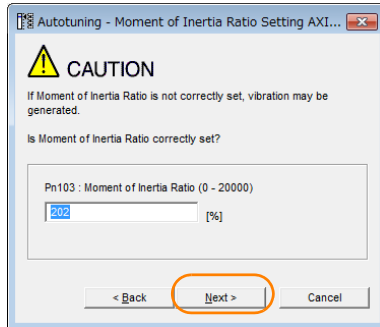

## 9. First confirm safety around moving parts. Turn ON the servo, enter a reference from the host controller, and then click the Start tuning Button.

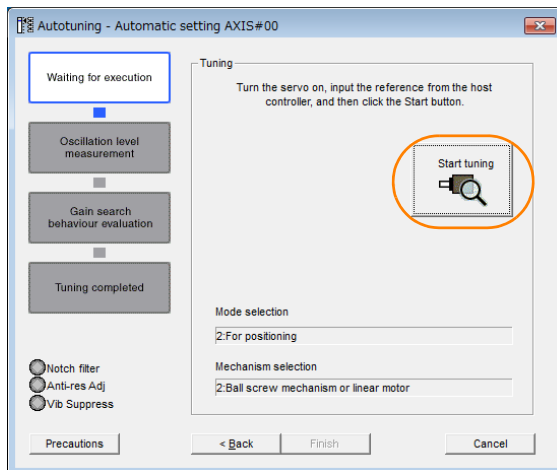



**10. Click the Yes Button.**

Tuning will be executed.

Vibration that occurs during tuning will be detected automatically and suitable settings will be made for that vibration. When the settings have been completed, the indicators for the functions that were used will light at the lower left of the dialog box.

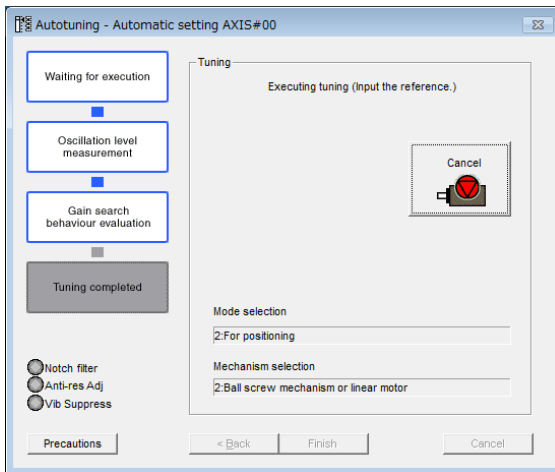
**11. When tuning has been completed, click the Finish Button.**

The results of tuning will be set in the parameters and you will return to the Tuning Dialog Box. This concludes the procedure to perform autotuning with a host reference.

## 8.7.5 Troubleshooting Problems in Autotuning with a Host Reference

The following tables give the causes of and corrections for problems that may occur in autotuning with a host reference.

### ◆ Autotuning with a Host Reference Was Not Performed

Possible Cause	Corrective Action
Main circuit power supply is OFF.	Turn ON the main circuit power supply.
An alarm or warning occurred.	Remove the cause of the alarm or warning.
Overtraveling occurred.	Remove the cause of overtraveling.
The second gains were selected with the gain selection.	Disable automatic gain switching.

### ◆ Troubleshooting Errors

Error	Possible Cause	Corrective Action
The gain adjustments were not successfully completed.	Machine vibration occurs or positioning completion is not stable when the Servomotor stops.	<ul style="list-style-type: none"> <li>• Increase the setting of the positioning completed width (Pn522).</li> <li>• Change the mode from 2 to 3.</li> <li>• If machine vibration occurs, suppress the vibration with the anti-resonance control adjustment and the vibration suppression function.</li> </ul>
Positioning was not completed within approximately 10 seconds after position adjustment was completed.	The positioning completed width is too narrow or proportional control is being used.	<ul style="list-style-type: none"> <li>• Increase the setting of the positioning completed width (Pn522).</li> <li>• Set V_PPI to 0 in the servo command output signals (SVCMD_IO).</li> </ul>

### ◆ Adjustment Results Are Not Satisfactory for Position Control

You may be able to improve the adjustment results by changing the settings of the positioning completed width (Pn522) and the electronic gear (Pn20E/Pn210).

If satisfactory results are still not possible, adjust the overshoot detection level (Pn561). That may improve the adjustment results.

- Pn561 = 100% (default setting)  
This will allow tuning with overshooting that is equivalent to the positioning completed width.
- Pn561 = 0%  
This will allow tuning to be performed without overshooting within the positioning completed width, but the positioning completed width may be extended.

Pn561	Overshoot Detection Level			Speed	Position	Torque
	Setting Range	Setting Unit	Default Setting	When Enabled	Classification	
	0 to 100	1%	100	Immediately	Setup	

## 8.7.6 Automatically Adjusted Function Settings

These function settings are the same as for autotuning without a host reference. Refer to the following section.

 8.6.6 Automatically Adjusted Function Settings on page 8-32

## 8.7.7 Related Parameters

The following parameters are automatically adjusted or used as reference when you execute autotuning with a host reference.

Do not change the settings while autotuning with a host reference is being executed.

Parameter	Name	Automatic Changes
Pn100	Speed Loop Gain	Yes
Pn101	Speed Loop Integral Time Constant	Yes
Pn102	Position Loop Gain	Yes
Pn103	Moment of Inertia Ratio	No
Pn121	Friction Compensation Gain	Yes
Pn123	Friction Compensation Coefficient	Yes
Pn124	Friction Compensation Frequency Correction	No
Pn125	Friction Compensation Gain Correction	Yes
Pn401	First Stage First Torque Reference Filter Time Constant	Yes
Pn408	Torque-Related Function Selections	Yes
Pn409	First Stage Notch Filter Frequency	Yes
Pn40A	First Stage Notch Filter Q Value	Yes
Pn40C	Second Stage Notch Filter Frequency	Yes
Pn40D	Second Stage Notch Filter Q Value	Yes
Pn140	Model Following Control-Related Selections	Yes
Pn141	Model Following Control Gain	Yes
Pn142	Model Following Control Gain Correction	Yes
Pn143	Model Following Control Bias in the Forward Direction	Yes
Pn144	Model Following Control Bias in the Reverse Direction	Yes
Pn145	Vibration Suppression 1 Frequency A	Yes
Pn146	Vibration Suppression 1 Frequency B	Yes
Pn147	Model Following Control Speed Feedforward Compensation	Yes
Pn160	Anti-Resonance Control-Related Selections	Yes
Pn161	Anti-Resonance Frequency	Yes
Pn163	Anti-Resonance Damping Gain	Yes

Yes: The parameter is automatically set.

No: The parameter is not automatically set, but the setting is read during execution.

## 8.8 Custom Tuning

This section describes custom tuning.

### 8.8.1 Outline

You can use custom tuning to manually adjust the servo during operation using a speed or position reference input from the host controller. You can use it to fine-tune adjustments that were made with autotuning.

The following items are adjusted automatically.

- Gains (e.g., speed loop gain and position loop gain)
- Filters (torque reference filter and notch filters)
- Friction compensation
- Anti-resonance control

Refer to the following section for details on the parameters that are adjusted.

 [8.8.7 Related Parameters](#) on page 8-51

There are two adjustment methods that you can use for custom tuning.

- **Tuning Mode 0 (Setting Servo Gains Giving Priority to Stability) or 1 (Setting Servo Gains Giving Priority to Good Response)**

These modes allow you to set stable control conditions for multiple servo gains by manipulating only one tuning level. Automatic setting of notch filters and anti-resonance control is provided if vibration is detected. Manual anti-resonance control adjustment is also possible during custom tuning.

- **Tuning Mode 2 (Setting Servo Gains Giving Priority to Position Control Applications) or 3 (Setting Servo Gains Giving Priority to Preventing Overshooting in Position Control Applications)**

Two tuning levels are manipulated to reduce positioning time even further and set multiple servo gains.

Model following control is used to reduce the positioning time. If vibration is detected, notch filters and anti-resonance control are automatically adjusted, and friction compensation is automatically set. Manual anti-resonance control adjustment and vibration suppression are also possible during custom tuning.

### CAUTION

- Vibration or overshooting may occur during custom tuning. To ensure safety, make sure that you can perform an emergency stop at any time.



### 8.8.2 Preparations

Always check the following before you execute custom tuning.

- The test without a motor function must be disabled (Pn00C = n.□□□0).
- The tuning-less function must be disabled (Pn170 = n.□□□0).
- If speed control is used, tuning mode 0 or 1 must be set.
- The parameters must not be write prohibited.

## 8.8.3 Applicable Tools

The following table lists the tools that you can use to perform custom tuning and the applicable tool functions.

Tool	Function	Operating Procedure Reference
Digital Operator	Fn203	 $\Sigma$ -7-Series Digital Operator Operating Manual (Manual No.: SIEP S800001 33)
SigmaWin+	<b>Tuning – Tuning</b>	 8.8.4 Operating Procedure on page 8-44

## 8.8.4 Operating Procedure

Use the following procedure to perform custom tuning.



### WARNING

- Before you execute custom tuning, check the information provided in the SigmaWin+ operating manual. Observe the following precautions.
  - Make sure that you can perform an emergency stop at any time. When custom tuning is started, several parameters will be overwritten with the recommended settings, which may greatly affect the response before and after execution. Make sure that you can perform an emergency stop at any time.
  - Set the moment of inertia correctly before you execute custom tuning. If the setting greatly differs from the actual moment of inertia, vibration may occur.
  - If you change the feedforward level, the new setting will not be used immediately. It will be used after positioning is completed.



### CAUTION

- If you are using an MP3000-series Controller for phase control, set the tuning mode to 0 or 1. If 2 or 3 is selected for the tuning mode, correct phase control may not be possible.

1. Confirm that the moment of inertia ratio (Pn103) is set correctly.
2. Click the  Servo Drive Button in the workspace of the Main Window of the SigmaWin+.
3. **Select Tuning in the Menu Dialog Box.**  
The Tuning Dialog Box will be displayed.  
Click the **Cancel** Button to cancel tuning.

4. Click the Execute Button.

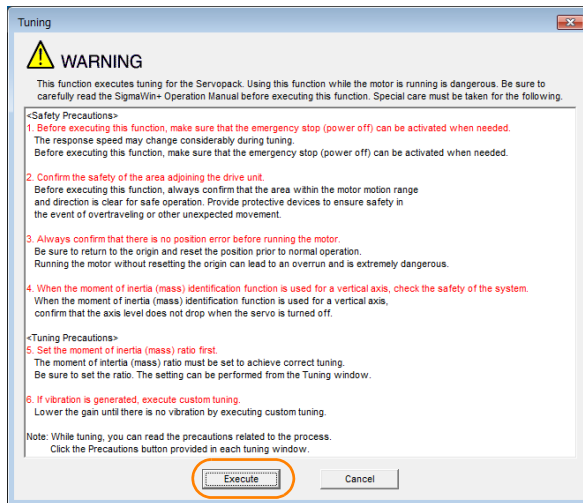

5. Click the Advanced adjustment Button.

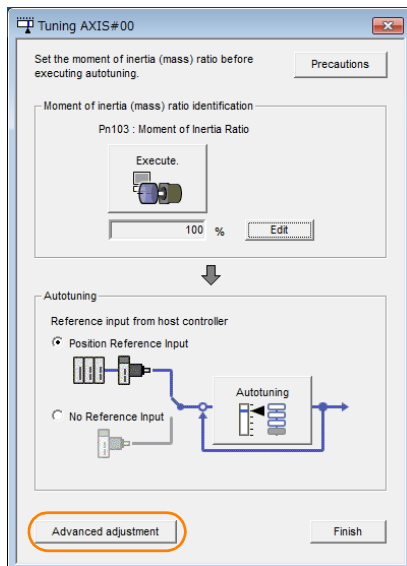

**Information** When the following dialog box is displayed, click the **OK** Button and then confirm that the correct moment of inertia ratio is set in Pn103 (Moment of Inertia Ratio).

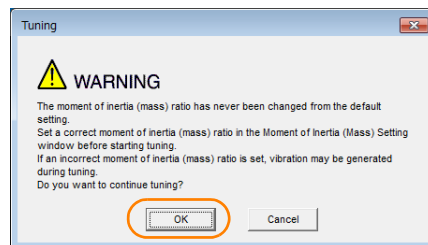

6. Click the Custom tuning Button.

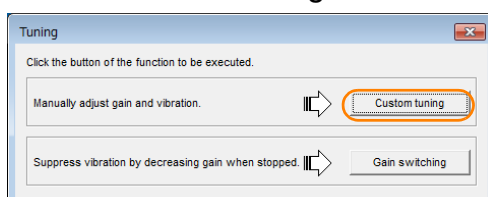

7. Set the Tuning mode Box and Mechanism selection Box, and then click the Next Button.

**Tuning mode Box**

Mode Selection	Description
0: Set servo gains with priority given to stability.	This setting gives priority to stability and preventing overshooting. In addition to gain adjustment, notch filters and anti-resonance control (except during torque control) are automatically adjusted.
1: Set servo gains with priority given to response.	Overshooting may occur because priority is given to response. In addition to gain adjustment, notch filters and anti-resonance control (except during torque control) are automatically adjusted.
2: Set servo gains for positioning application.	Tuning is performed for positioning applications. In addition to gain adjustment, notch filters, anti-resonance control, and vibration suppression are adjusted.
3: Set servo gains especially to prevent overshooting during positioning application.	Tuning is performed for positioning applications with emphasis on eliminating overshooting. In addition to gain adjustment, notch filters, anti-resonance control, and vibration suppression are adjusted.

• **Mechanism Selection Box**

Select the type according to the machine element to drive. If there is noise or if the gain does not increase, better results may be obtained by changing the rigidity type. Select the type according to the following guidelines.

Mechanism Selection	Description
1: Belt mechanism	Tuning is performed for a mechanism with relatively low rigidity, e.g., a belt.
2: Ball screw mechanism or Linear motor	Tuning is performed for a mechanism with relatively high rigidity, e.g., a ball screw or Linear Servomotor. Use this setting if there is no other appropriate setting.
3: Rigid body system	Tuning is performed for a mechanism with high rigidity, e.g., a rigid body system.

**Information** The tuning modes that you can select depend on the SERVOPACK setting.

8. If the moment of inertia ratio is not set correctly, correct the setting and then click the Next Button.

9. Turn ON the servo, enter a reference from the host controller, and then click the **Start tuning Button**.

Tuning Mode 0 or 1

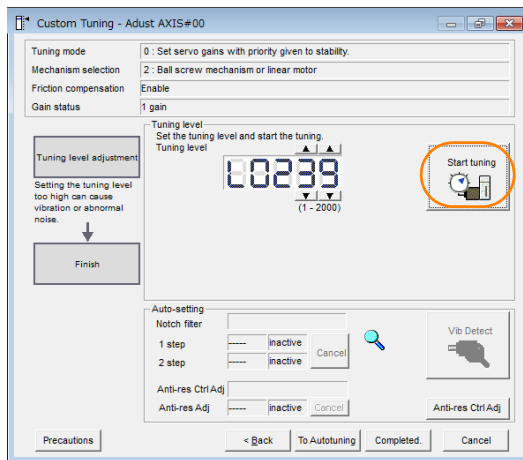

Tuning Mode 2 or 3

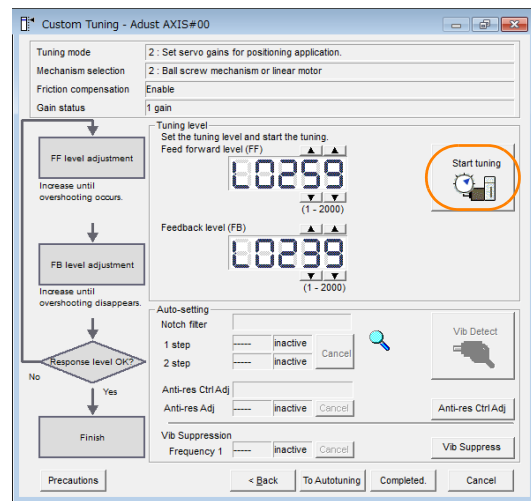

10. Use the ▲ and ▼ Buttons to change the tuning level.

Click the **Back Button** during tuning to restore the setting to its original value. The tuning level will return to the value from before when custom tuning was started.

Tuning Mode 0 or 1

Increase the tuning level until overshooting occurs.

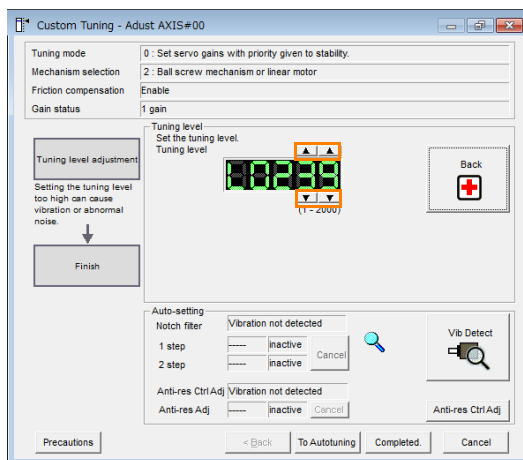

Tuning Mode 2 or 3

Increase the feedforward level until overshooting occurs and then increase the feedback level until overshooting is eliminated. Repeat these changes to make the adjustment.

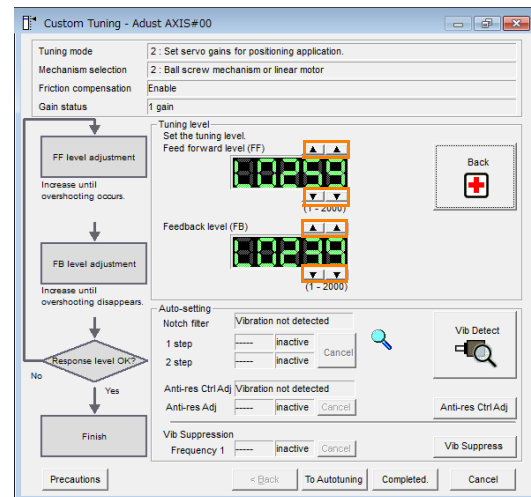

**Information** The new feedforward level will not be used until the positioning completed signal is output.

11. You can set the functions to suppress vibration (notch filters, automatic anti-resonance control setting, anti-resonance control adjustment, and autotuning with a host reference) as required.

Refer to the following section for details.

*Vibration Suppression Functions* on page 8-49



**12. When tuning has been completed, click the Completed Button.**

The values that were changed will be saved in the SERVOPACK and you will return to the Tuning Dialog Box.

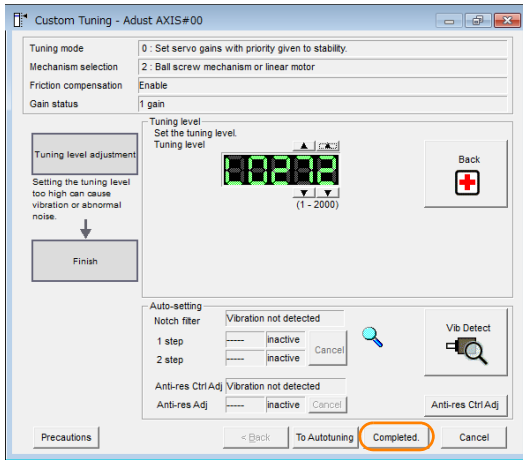

This concludes the procedure to set up custom tuning.

## Vibration Suppression Functions

### ◆ Notch Filters and Automatic Anti-resonance Control Setting

If the vibration frequency that occurs when you increase the servo gains is at 1,000 Hz or higher, notch filters are effective to suppress vibration. If the vibration is between 100 Hz and 1,000 Hz, anti-resonance control is effective.

### ◆ Automatic Setting

To set vibration suppression automatically, use the parameters to enable notch filters and automatic anti-resonance control setting.

The notch filter frequency (stage 1 or 2) or anti-resonance control frequency that is effective for the vibration that was detected during tuning will be automatically set.

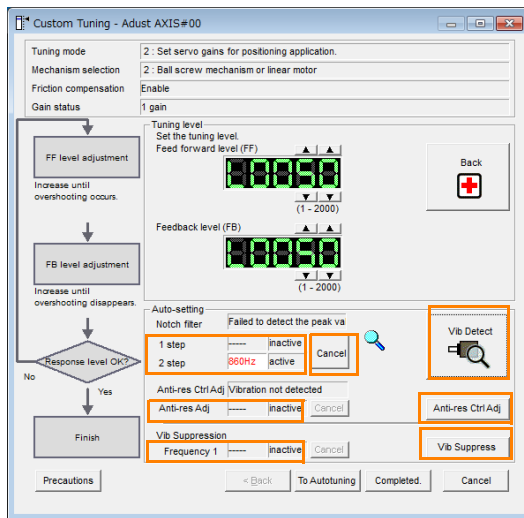

- **Auto-setting Cancel Buttons**

The automatically set notch filter frequencies or the anti-resonance control frequencies may not always suppress vibration. Click the **Cancel** Button to reset the notch filter frequencies or the anti-resonance control frequencies to the values from just before these frequencies were set automatically.

When they are reset, vibration detection will start again.

- **Vib Detect Button**

While the notch filter or automatic anti-resonance control setting function is enabled, you can click the **Vib Detect** Button to manually detect vibration. When you click the **Vib Detect** Button, the SERVOPACK will detect vibration at that time, and set the notch filter frequency (stage 1 or 2) or anti-resonance control frequency that is effective for the detected vibration. You can also perform manual vibration detection even when the SERVOPACK does not detect vibration.

- **Anti-res Ctrl Adj Button**

You can use the **Anti-res Ctrl Adj** Button to execute the anti-resonance control adjustment if fine-tuning is required. Refer to the following section.

8.9 *Anti-Resonance Control Adjustment* on page 8-52

- **Vib Suppress Button**

Click the **Vib Suppress** Button to suppress low and transient vibration (oscillation) of approximately 1 Hz to 100 Hz that occurs during positioning. Refer to the following section.

8.10 *Vibration Suppression* on page 8-57

### ◆ Autotuning with a Host Reference

You can perform autotuning with a host reference. Refer to the following section for details.



8.7 *Autotuning with a Host Reference* on page 8-35

## 8.8.5 Automatically Adjusted Function Settings

You cannot use vibration suppression functions at the same time. Other automatic function settings are the same as for autotuning without a host reference. Refer to the following section.

 8.6.6 Automatically Adjusted Function Settings on page 8-32

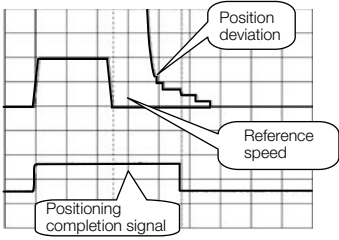
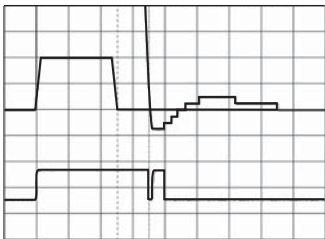
## 8.8.6 Tuning Example for Tuning Mode 2 or 3

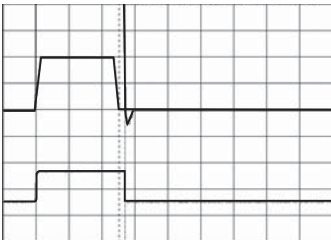
Step	Measurement Display Examples	Operation
1		<p>The positioning time is measured after the moment of inertia ratio (Pn103) is set correctly. Tuning is completed if the specifications are met. The tuning results are saved in the SERVOPACK.</p>
2		<p>The positioning time will be reduced if the feedforward level is increased. Tuning is completed if the specifications are met. The tuning results are saved in the SERVOPACK. If overshooting occurs before the specifications are met, proceed to step 3.</p>
3		<p>Overshooting will be reduced if the feedback level is increased. If the overshooting is eliminated, proceed to step 4.</p>
4		<p>The graph shows overshooting that occurred when the feedforward level was increased even more after step 3. In this state, overshooting occurs, but the positioning settling time is shorter. Tuning is completed if the specifications are met. The tuning results are saved in the SERVOPACK. If overshooting occurs before the specifications are met, repeat steps 3 and 4. If vibration occurs before the overshooting is eliminated, the vibration is suppressed with the notch filters and anti-resonance control.</p>
5	-	<p>The tuning results are saved in the SERVOPACK.</p>

## 8.8.7 Related Parameters

The following parameters are automatically adjusted or used as reference when you execute custom tuning.

Do not change the settings while custom tuning is being executed.

Parameter	Name	Automatic Changes
Pn100	Speed Loop Gain	Yes
Pn101	Speed Loop Integral Time Constant	Yes
Pn102	Position Loop Gain	Yes
Pn103	Moment of Inertia Ratio	No
Pn121	Friction Compensation Gain	Yes
Pn123	Friction Compensation Coefficient	Yes
Pn124	Friction Compensation Frequency Correction	No
Pn125	Friction Compensation Gain Correction	Yes
Pn401	First Stage First Torque Reference Filter Time Constant	Yes
Pn408	Torque-Related Function Selections	Yes
Pn409	First Stage Notch Filter Frequency	Yes
Pn40A	First Stage Notch Filter Q Value	Yes
Pn40C	Second Stage Notch Filter Frequency	Yes
Pn40D	Second Stage Notch Filter Q Value	Yes
Pn140	Model Following Control-Related Selections	Yes
Pn141	Model Following Control Gain	Yes
Pn142	Model Following Control Gain Correction	Yes
Pn143	Model Following Control Bias in the Forward Direction	Yes
Pn144	Model Following Control Bias in the Reverse Direction	Yes
Pn145	Vibration Suppression 1 Frequency A	No
Pn146	Vibration Suppression 1 Frequency B	No
Pn147	Model Following Control Speed Feedforward Compensation	Yes
Pn160	Anti-Resonance Control-Related Selections	Yes
Pn161	Anti-Resonance Frequency	Yes
Pn163	Anti-Resonance Damping Gain	Yes

Yes: The parameter is automatically set.

No: The parameter is not automatically set, but the setting is read during execution.

# 8.9 Anti-Resonance Control Adjustment

This section describes anti-resonance control.

## 8.9.1 Outline

Anti-resonance control increases the effectiveness of vibration suppression after custom tuning.

Anti-resonance control is effective for suppression of continuous vibration frequencies from 100 to 1,000 Hz that occur when the control gain is increased. Vibration can be eliminated by setting vibration frequencies through automatic detection or by manually setting them to adjust the damping gain. Input an operation reference and execute this anti-resonance control adjustment when there is vibration.

Anti-resonance control is automatically set by autotuning without a host reference or autotuning with a host reference. Use anti-resonance control adjustment only if fine-tuning is required or readjustment is required as a result of a failure to detect vibration.

Perform custom tuning if required to increase the response after performing anti-resonance control adjustment. If the control gain is increased, e.g., when custom tuning is performed, vibration may occur again. If that occurs, perform anti-resonance control adjustment again to fine-tune the parameters.

 **CAUTION**

- Related parameters will be set automatically when anti-resonance control adjustment is executed. This may greatly affect the response before and after execution. Make sure that you can perform an emergency stop at any time.
- Before you execute anti-resonance control adjustment, set the correct moment of inertia ratio (Pn103). If the setting greatly differs from the actual moment of inertia ratio, normal control of the machine may not be possible, and vibration may occur.

 **Important**

- Anti-resonance control adjustment detects vibration frequencies between 100 Hz and 1,000 Hz. If the vibration frequency is not within this range, use custom tuning with tuning mode 2 selected to automatically set a notch filter or use vibration suppression.
- Vibration reduction can be made more effective by increasing the anti-resonance damping gain (Pn163), but the vibration may become larger if the damping gain is too high. Increase the damping gain by approximately 0% to 200% in 10% increments while checking the effect on vibration. If vibration reduction is still insufficient at a gain of 200%, cancel the setting, and lower the control gain by using a different method, such as custom tuning.



## 8.9.2 Preparations

Always check the following before you execute anti-resonance control adjustment.

- The tuning-less function must be disabled (Pn170 = n.□□□0).
- The test without a motor function must be disabled (Pn00C = n.□□□0).
- The control method must not be set to torque control.
- The parameters must not be write prohibited.

## 8.9.3 Applicable Tools

The following table lists the tools that you can use to perform anti-resonance control adjustment and the applicable tool functions.

Tool	Function	Operating Procedure Reference
Digital Operator	Fn204	 $\Sigma$ -7-Series Digital Operator Operating Manual (Manual No.: SIEP S800001 33)
SigmaWin+	<b>Tuning - Tuning</b>	 8.9.4 Operating Procedure on page 8-53

## 8.9.4 Operating Procedure

To execute anti-resonance control adjustment, an operation reference is input, and the adjustment is executed while vibration is occurring.

The following methods can be used to execute anti-resonance control adjustment.

- To automatically detect the vibration frequency
- To manually set the vibration frequency

Use the following procedure to perform anti-resonance control.

### CAUTION

- Before you execute anti-resonance control adjustment, check the information provided in the SigmaWin+ operating manual.  
Observe the following precautions.
  - Make sure that you can perform an emergency stop at any time.  
Parameters will be set automatically when anti-resonance control adjustment is executed. This may greatly affect the response before and after execution. Make sure that you can perform an emergency stop (to turn OFF the power supply) at any time.
  - Set the moment of inertia correctly before you execute anti-resonance control adjustment.  
If the setting greatly differs from the actual moment of inertia, effective vibration reduction may not be possible.
  - If you have already performed anti-resonance control adjustment and then you change the frequency, the current anti-resonance control effect may be lost. Caution is particularly required when automatically detecting the vibration frequency.
  - If effective vibration reduction is not achieved even after you execute anti-resonance control adjustment, cancel the function and lower the control gain by using a different method, such as custom tuning.
  - Perform custom tuning separately if required to increase the response after performing anti-resonance control adjustment.  
If the servo gain is increased, e.g., when custom tuning is performed, vibration may occur again. If that occurs, perform anti-resonance control adjustment again to fine-tune the parameters.

1. Perform steps 1 to 8 of the procedure for custom tuning. Refer to the following section for details.

8.8.4 Operating Procedure on page 8-44

2. Click the **Anti-res Ctrl Adj Button**.

The rest of the procedure depends on whether you know the vibration frequency.

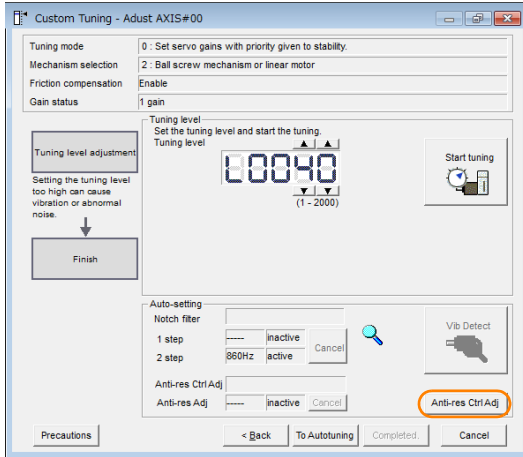

3. If you do not know the vibration frequency, click the **Auto Detect Button**. If you know the vibration frequency, click the **Manual Set Button**.

To Automatically Detect the Vibration Frequency

The frequency will be set.

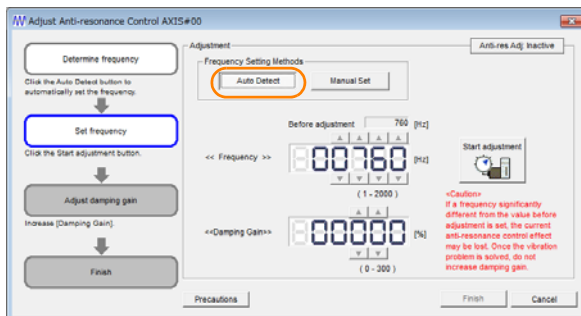

To Manually Set the Vibration Frequency

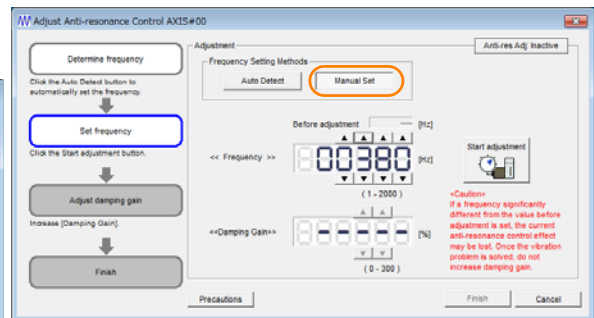

4. Click the **Start adjustment Button**.

5. Use the **▲** and **▼** Buttons in the **Adjustment Area** to change the settings.

Click the **Reset Button** during tuning to restore the setting to its original value. The tuning level will return to the value from before when custom tuning was started.

To Automatically Detect the Vibration Frequency

Change the setting of the damping gain.



To Manually Set the Vibration Frequency

Change the settings of the frequency and damping gain.

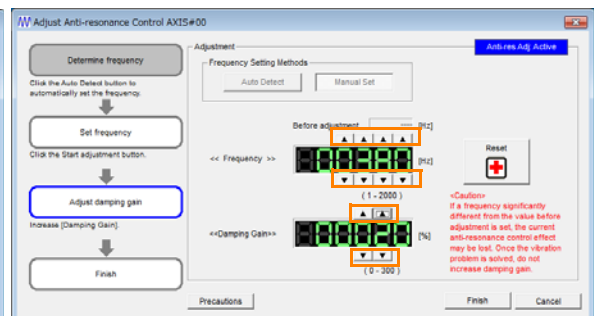

**6. When the adjustment has been completed, click the Finish Button.**

The values that were changed will be saved in the SERVOPACK and you will return to the Tuning Dialog Box.



This concludes the procedure to set up anti-resonance control.

## 8.9.5 Related Parameters

The following parameters are automatically adjusted or used as reference when you execute anti-resonance control adjustment.

Do not change the settings while anti-resonance control adjustment is being executed.

Parameter	Name	Automatic Changes
Pn160	Anti-Resonance Control-Related Selections	Yes
Pn161	Anti-Resonance Frequency	Yes
Pn162	Anti-Resonance Gain Correction	No
Pn163	Anti-Resonance Damping Gain	Yes
Pn164	Anti-Resonance Filter Time Constant 1 Correction	No
Pn165	Anti-Resonance Filter Time Constant 2 Correction	No

Yes: The parameter is automatically set.

No: The parameter is not automatically set, but the setting is read during execution.

## 8.9.6 Suppressing Different Vibration Frequencies with Anti-resonance Control

When you use anti-resonance control and increase the control gain, for some mechanism, vibration can occur at a higher frequency than the frequency for which vibration was suppressed. If this occurs, you can suppress vibration for more than one frequency by adjusting Pn166 (Anti-Resonance Damping Gain 2).

**Information**

**Guidelines for Vibration That Can Be Suppressed**

Anti-resonance frequency (Pn161):  $f_a$  [Hz], Another vibration frequency that occurs when the control gain is increased:  $f_b$  [Hz]

- Vibration frequencies: 100 Hz to 1,000 Hz
- Range of different vibration frequencies:  $1 < (f_b/f_a) \leq 3$  to 4



## Required Parameter Settings

The following parameter settings are required to use anti-resonance control for more than one vibration frequency.

Parameter		Description			When Enabled	Classification	
Pn160	n.□□□0 (default setting)	Do not use anti-resonance control.			After restart	Setup	
	n.□□□1	Use anti-resonance control.					
Pn161	Anti-Resonance Frequency				Speed	Position	Torque
	Setting Range	Setting Unit	Default Setting	When Enabled	Classification		
	10 to 20,000	0.1 Hz	1000	Immediately	Tuning		
Pn162	Anti-Resonance Gain Correction				Speed	Position	Torque
	Setting Range	Setting Unit	Default Setting	When Enabled	Classification		
	1 to 1,000	1%	100	Immediately	Tuning		
Pn163	Anti-Resonance Damping Gain				Speed	Position	Torque
	Setting Range	Setting Unit	Default Setting	When Enabled	Classification		
	0 to 300	1%	0	Immediately	Tuning		
Pn164	Anti-Resonance Filter Time Constant 1 Correction				Speed	Position	Torque
	Setting Range	Setting Unit	Default Setting	When Enabled	Classification		
	-1,000 to 1,000	0.01 ms	0	Immediately	Tuning		
Pn165	Anti-Resonance Filter Time Constant 2 Correction				Speed	Position	Torque
	Setting Range	Setting Unit	Default Setting	When Enabled	Classification		
	-1,000 to 1,000	0.01 ms	0	Immediately	Tuning		
Pn166	Anti-Resonance Damping Gain 2				Speed	Position	Torque
	Setting Range	Setting Unit	Default Setting	When Enabled	Classification		
	0 to 1,000	1%	0	Immediately	Tuning		

## Adjustment Procedure for Suppressing Different Vibration Frequencies with Anti-resonance Control

Use the following procedure to make adjustments to suppress different vibration frequencies with anti-resonance control.

Step	Operation
1	Use the gain adjustment and anti-resonance control. Refer to the following section for details.  8.9.4 Operating Procedure on page 8-53
2	If there is vibration at a higher frequency than the vibration suppressed with anti-resonance control in step 1, adjust Pn166 (Anti-Resonance Damping Gain 2).
3	Adjust Pn166 (Anti-Resonance Damping Gain 2) while checking to see if vibration reduction is effective. To adjust Pn166 (Anti-Resonance Damping Gain 2), increase the setting by 10% at a time starting from the value that resulted in Pn163 (Anti-Resonance Damping Gain) from the adjustment in step 1.
4	If the vibration disappears, the adjustment is completed. However, if the vibration does not disappear even when you adjust Pn166 (Anti-Resonance Damping Gain 2), reduce the tuning level or feedback level until vibration does not occur.

## 8.10 Vibration Suppression

This section describes vibration suppression.

### 8.10.1 Outline

You can use vibration suppression to suppress transient vibration at a low frequency from 1 Hz to 100 Hz, which is generated mainly when the machine vibrates during positioning. This is effective for vibration frequencies for which notch filters and anti-resonance control adjustment are not effective.

Vibration suppression is automatically set by autotuning without a host reference or autotuning with a host reference. Use vibration suppression only if fine-tuning is required or readjustment is required as a result of a failure to detect vibration. To execute vibration suppression, input an operation reference and execute the function when there is vibration.

Perform custom tuning if required to increase the response after performing vibration suppression.

#### CAUTION

- Related parameters will be set automatically when vibration suppression is executed. This may greatly affect the response before and after execution. Make sure that you can perform an emergency stop at any time.
- Before you execute vibration suppression, set the correct moment of inertia ratio (Pn103) with autotuning without a host reference or another method. If the setting greatly differs from the actual moment of inertia ratio, normal control of the machine may not be possible, and vibration may occur.
- If you execute vibration suppression when you are using an MP3000-Series Controller for phase control, correct phase control may not be possible.



Important

- Vibration suppression detects vibration frequencies between 1 Hz and 100 Hz.
- Frequency detection will not be performed if there is no vibration in the position deviation or if the vibration frequency is outside the range of detectable frequencies. If that is a problem, use a device such as a displacement meter or vibration sensor to measure the vibration frequency.
- If an automatically detected vibration frequency is not suppressed, the actual frequency and the detected frequency may be different. Fine-tune the detected frequency if necessary.

### Items That Influence Performance

If continuous vibration occurs while the Servomotor is stopping, vibration suppression cannot be used to suppress the vibration effectively. In this case, use anti-resonance control adjustment or custom tuning.

## Detection of Vibration Frequencies

Frequency detection may not be possible if vibration does not appear in the position deviation or the vibration that results from the position deviation is too small. You can adjust the detection sensitivity by changing the setting of the residual vibration detection width (Pn560), which is set as a percentage of the positioning completed width (Pn522). Perform the detection of vibration frequencies again after adjusting the setting of Pn560.

Pn560	Residual Vibration Detection Width				Position
	Setting Range	Setting Unit	Default Setting	When Enabled	Classification
	1 to 3,000	0.1%	400	Immediately	Setup

Note: As a guideline, change the setting 10% at a time. If the setting of this parameter is lowered, the detection sensitivity will be increased. Vibration may not be detected accurately if the setting is too small.

**Information** The vibration frequencies that are automatically detected may vary somewhat with each positioning operation. Perform positioning several times and make adjustments while checking the effect of vibration suppression.



### 8.10.2 Preparations

Always check the following before you execute vibration suppression.

- Position control must be used.
- The tuning-less function must be disabled (Pn170 = n.□□□0).
- The test without a motor function must be disabled (Pn00C = n.□□□0).
- The parameters must not be write prohibited.

### 8.10.3 Applicable Tools

The following table lists the tools that you can use to perform vibration suppression and the applicable tool functions.

Tool	Function	Operating Procedure Reference
Digital Operator	Fn205	 Σ-7-Series Digital Operator Operating Manual (Manual No.: SIEP S800001 33)
SigmaWin+	<b>Tuning - Tuning</b>	 8.10.4 Operating Procedure on page 8-59

## 8.10.4 Operating Procedure

Use the following procedure to perform vibration suppression.

1. Perform steps 1 to 8 of the procedure for custom tuning. Refer to the following section for details.

 8.8.4 Operating Procedure on page 8-44

2. Click the **Vib Suppress** Button.

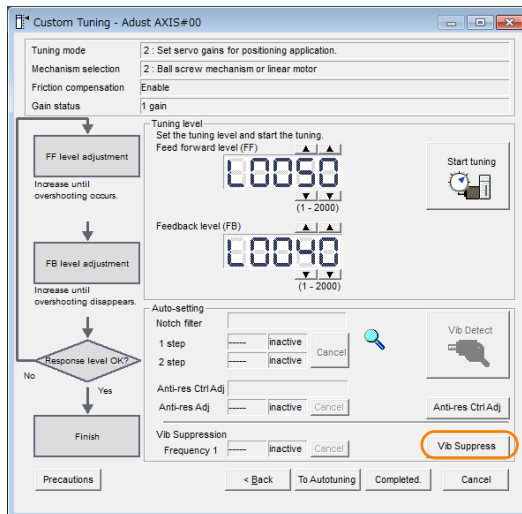

3. Click the **Import** Button or click **▲** and **▼** Button to manually adjust the set frequency. When you click the **Import** Button, the residual vibration frequency in the Servomotor is read as the set frequency. (The frequency can be read only when the residual vibration frequency is between 1.0 and 100.0.)



Important

Frequency (FB) detection will not be performed if there is no vibration or if the vibration frequency is outside the range of detectable frequencies. If a vibration frequency is not detected, provide a means of measuring the vibration frequency.

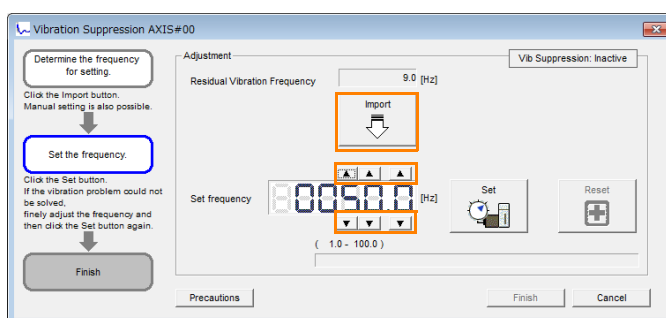

4. Click the **Set Button**.



**Important**

No settings related to vibration suppression are changed during operation. If the Servomotor does not stop within approximately 10 seconds after changing the setting, an update timeout will occur. The setting will be automatically returned to the previous value.

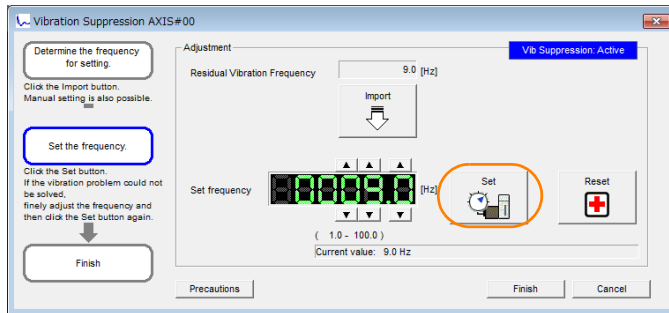

If the vibration is not eliminated, use the ▲ and ▼ Buttons for the set frequency to fine-tune the value and click the **Set Button** again.

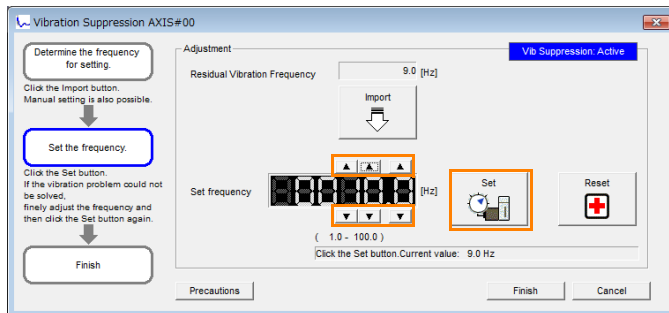

Click the **Reset** Button during adjustment to restore the setting to its original value. The status from before when adjustment was started will be restored.

5. When the vibration has been eliminated, click the **Finish Button**.  
The updated value will be saved in the SERVOPACK.



**Important**

Vibration suppression will be enabled in step 5. The Servomotor response, however, will change when the Servomotor comes to a stop with no reference input.

This concludes the procedure to set up vibration suppression.

## 8.10.5 Setting Combined Functions

You can also use the feedforward function when you execute vibration suppression.

In the default settings, feedforward (Pn109), the speed feedforward input (VFF), and the torque feedforward input (TFF) are disabled.

To use the speed feedforward input (VFF), the torque feedforward input (TFF), and model following control from the host controller in the system, set Pn140 to n.1□□□ (Use model following control and speed/torque feedforward together).

Parameter		Function	When Enabled	Classification
Pn140	n.0□□□ (default setting)	Do not use model following control and speed/torque feedforward together.	Immediately	Tuning
	n.1□□□	Use model following control and speed/torque feedforward together.		

Refer to the following manual for information on the torque feedforward input (TFF) and the speed feedforward input (VFF).

📖  $\Sigma$ -7-Series MECHATROLINK-III Communications Standard Servo Profile Command Manual (Manual No.: SIEP S800001 31)



Important

When model following control is used with the feedforward function, it is used to make optimum feedforward settings in the SERVOPACK. Therefore, model following control is not normally used together with either the speed feedforward input (VFF) or torque feedforward input (TFF) from the host controller. However, model following control can be used with the speed feedforward input (VFF) or torque feedforward input (TFF) if required. An unsuitable feedforward input may result in overshooting.

## 8.10.6 Related Parameters

The following parameters are automatically adjusted or used as reference when you execute vibration suppression.

Do not change the settings while vibration suppression is being executed.

Parameter	Name	Automatic Changes
Pn140	Model Following Control-Related Selections	Yes
Pn141	Model Following Control Gain	Yes
Pn142	Model Following Control Correction	No
Pn143	Model Following Control Bias in the Forward Direction	No
Pn144	Model Following Control Bias in the Reverse Direction	No
Pn145	Vibration Suppression 1 Frequency A	Yes
Pn146	Vibration Suppression 1 Frequency B	Yes
Pn147	Model Following Control Speed Feedforward Compensation	No
Pn14A	Vibration Suppression 2 Frequency	No
Pn14B	Vibration Suppression 2 Correction	No

Yes: The parameter is automatically set.

No: The parameter is not automatically set, but the setting is read during execution.

## 8.11 Speed Ripple Compensation

This section describes speed ripple compensation.

### 8.11.1 Outline

Speed ripple compensation reduces the amount of ripple in the motor speed due to torque ripple or cogging torque. You can enable speed ripple compensation to achieve smoother operation. To enable it, you must set up ripple compensation on the SigmaWin+.



#### WARNING

- Speed ripple compensation requires operating the Servomotor and therefore presents hazards. Observe the following precaution.  
Confirm safety around moving parts.  
This function involves automatic operation. Make sure that you can perform an emergency stop (to turn OFF the power supply) at any time.



Important

Execute speed ripple compensation only after adjusting the gains.

- Reset speed ripple compensation after you replace the Servomotor or SERVOPACK.
- Execute speed ripple compensation after jogging to a position that ensures a suitable range of motion.

### 8.11.2 Setting Up Speed Ripple Compensation

#### Restrictions

The following restrictions apply to the setup for speed ripple compensation.

#### ◆ Systems for Which Execution Cannot Be Performed

There are no restrictions.

#### ◆ Systems for Which Adjustments Cannot Be Made Accurately

Systems for which there is not a suitable range of motion

#### ◆ Preparations

Always check the following before you set up speed ripple compensation.

- The main circuit power supply must be ON.
- The servo must be OFF.
- There must be no alarms or warnings.
- The parameters must not be write prohibited.

## Applicable Tools

The following table lists the tools that you can use to set up speed ripple compensation and the applicable tool functions.

Tool	Function	Reference
Digital Operator	You cannot set up speed ripple compensation from the Digital Operator.	
SigmaWin+	<b>Solutions – Ripple Compensation</b>	 <i>Operating Procedure</i> on page 8-63

## Operating Procedure

Use the following procedure to set up speed ripple compensation.

1. Click the  Servo Drive Button in the workspace of the Main Window of the SigmaWin+.
2. Select **Ripple Compensation** in the Menu Dialog Box.  
The Ripple Compensation Dialog Box will be displayed.
3. Click the **OK** Button.

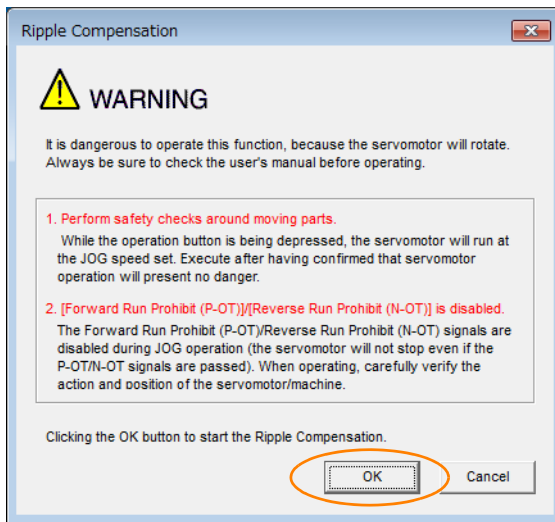

- Information**
1. Click the **Cancel** Button to cancel ripple compensation. The Main Window will return.
  2. If write protection is set, the following dialog box will be displayed.

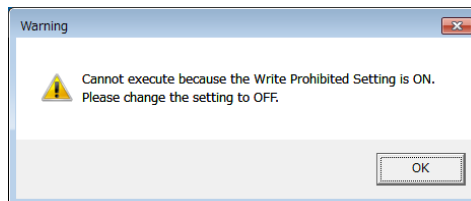

Click the **OK** Button to cancel write prohibition.



## 8.11 Speed Ripple Compensation

### 8.11.2 Setting Up Speed Ripple Compensation

4. Click the **Edit** Button.

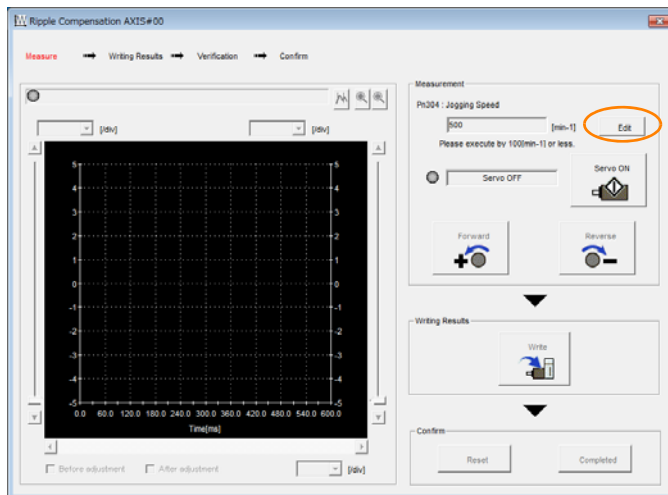

5. Enter the jogging speed in the **Input Value Box** and click the **OK** Button.

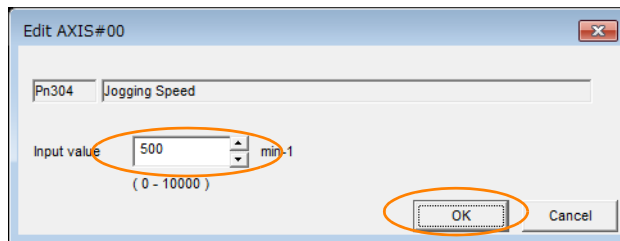

6. Click the **Servo ON** Button.

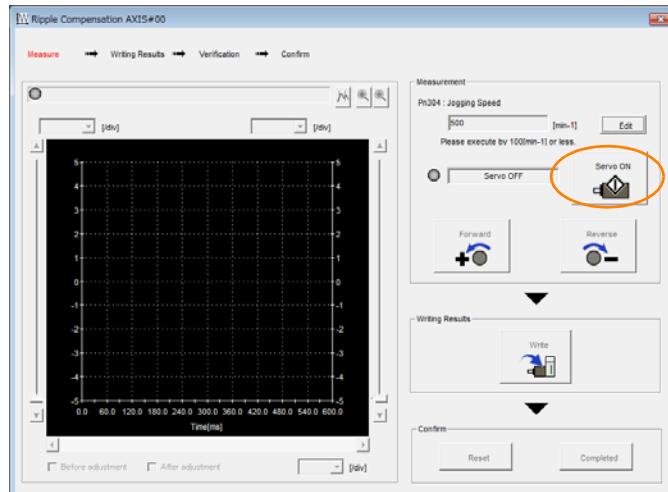

7. Click the **Forward Button** or the **Reverse Button**.

Measurement operation is started.

The Servomotor shaft will rotate at the preset jogging speed while you hold down the **Forward** or **Reverse** Button and the speed ripple will be measured.

The feedback speed and torque reference graph will be displayed in the Ripple Compensation Dialog Box during jogging.

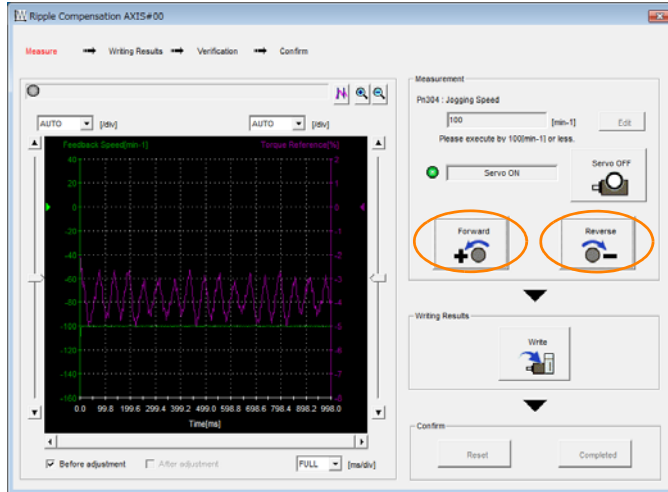

Important

If the measurement time (i.e., the jogging time) for the speed ripple is too short, speed ripple measurement will not be completed. The following dialog box will be displayed if speed ripple measurement was not completed.

Click the **OK** Button and repeat the measurement.

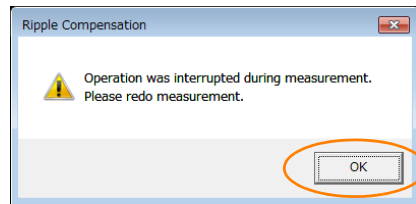

8. After speed ripple measurement has been completed, click the **Write** Button.

The ripple compensation value will be written to the SERVOPACK.

9. After writing has been completed, click the **OK** Button.

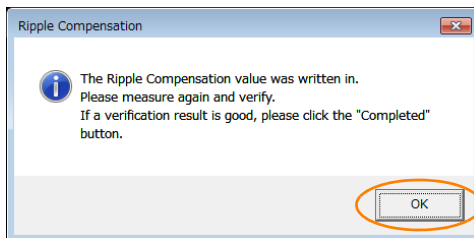

**10. Click the Forward Button or the Reverse Button.**

Verification operation is started.

The Servomotor shaft will rotate at the preset jogging speed while you hold down the **Forward** or **Reverse** Button.

The waveform with speed ripple compensation applied to it will be displayed.

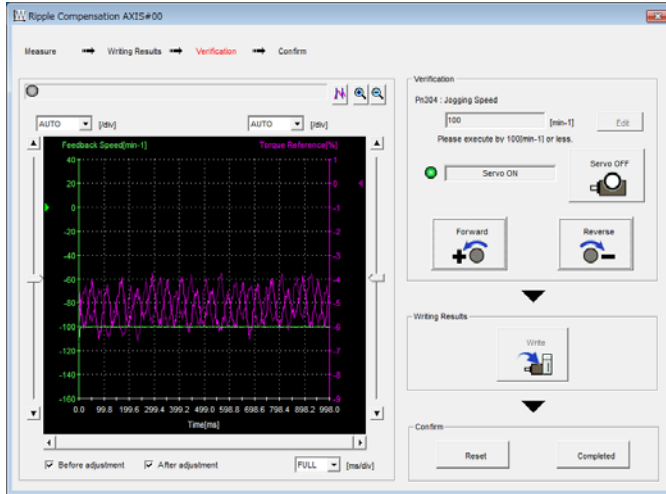

**11. If the verification results are OK, click the Completed Button.**

**Information** To discard the setup results, click the **Reset** Button.

This concludes the setup for speed ripple compensation.

## 8.11.3 Setting Parameters

The function is enabled when you perform the operating procedure on *Operating Procedure* on page 8-63. To cancel speed ripple compensation, use Pn423 = n.□□□0 (Disable speed ripple compensation) to disable it.

Parameter	Description	When Enabled	Classification
Pn423	n.□□□0 (default setting)	Immediately	Setup
	n.□□□1		

If you enable speed ripple compensation, a compensation reference will be applied to reduce ripple even when stopped at a 0 speed reference. In speed control mode, this may result in the Servomotor moving slightly. To prevent this, set Pn423 = n.□X□□ (Speed Ripple Compensation Enable Condition Selection) and Pn427 or Pn49F (Speed Ripple Compensation Enable Speed).

Parameter	Description	When Enabled	Classification
Pn423	n.□0□□ (default setting)	After restart	Setup
	n.□1□□		

- For Rotary Servomotors

Pn427	Speed Ripple Compensation Enable Speed			Speed	Position	Torque
	Setting Range	Setting Unit	Default Setting	When Enabled	Classification	
	0 to 10,000	1 min <sup>-1</sup>	0	Immediately	Tuning	

- For Linear Servomotors

Pn49F	Speed Ripple Compensation Enable Speed			Speed	Position	Torque
	Setting Range	Setting Unit	Default Setting	When Enabled	Classification	
	0 to 10,000	1 mm/s	0	Immediately	Tuning	

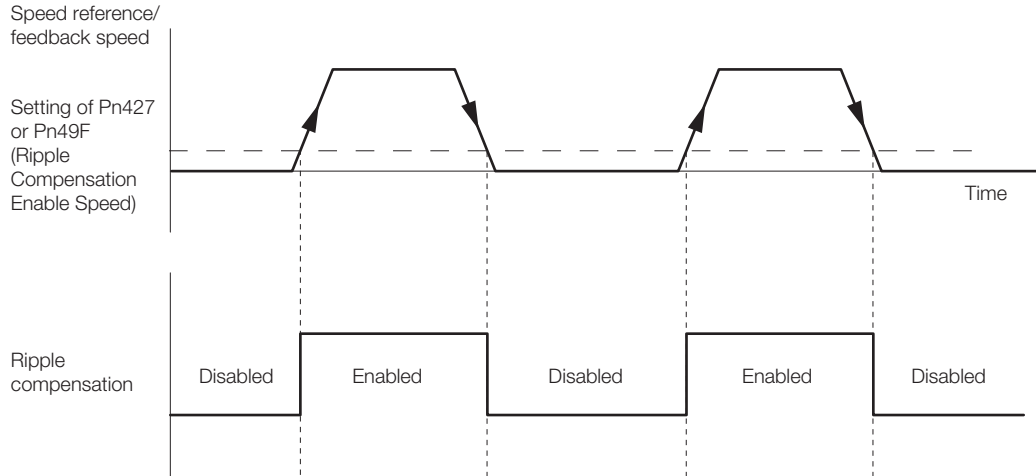

## Speed Ripple Compensation Warnings

The speed ripple compensation value is specific to each Servomotor. If you replace the Servomotor while speed ripple compensation is enabled, an A.942 warning (Speed Ripple Compensation Information Disagreement) will occur to warn you.

You can use any of the following methods to clear A.942.

- Reset the speed ripple compensation value on the SigmaWin+.
- Disable speed ripple compensation (Pn423 = n.□□□0).
- Disable detection of A.942 (Pn423 = n.□□1□).

Parameter	Description	When Enabled	Classification
Pn423	n.□□0□ (default setting)	After restart	Setup
	n.□□1□		

# 8.12 Additional Adjustment Functions

This section describes the functions that you can use to make adjustments after you perform autotuning without a host reference, autotuning with a host reference, and custom tuning.

Function	Applicable Control Methods	Reference
Gain Switching	Position control, speed control, or torque control*	page 8-68
Friction Compensation	Position control or speed control	page 8-72
Current Gain Level Setting	Position control or speed control	page 8-75
Speed Detection Method Selection	Position control, speed control, or torque control	page 8-76
Backlash Compensation	Position Control	page 8-76

\* Automatic gain switching is enabled only for position control.

## 8.12.1 Gain Switching

Two gain switching functions are available, manual selection and automatic switching. The manual switching function uses an external input signal to select the gains, and the automatic switching function changes the gains automatically. You can use gain switching to shorten the positioning time by increasing the gains during positioning and suppressing vibration by decreasing the gains while stopping.

Parameter	Function	When Enabled	Classification
Pn139	n.□□□0 (default setting)	Immediately	Tuning
	n.□□□2		

Note: Pn139 = n.□□□1 is a reserved setting. Do not use this setting.

Refer to the following section for gain switching combinations.

[Gain Switching Combinations](#) on page 8-68

Refer to the following sections for information on manual and automatic gain switching.

[Manual Gain Switching](#) on page 8-69 and [Automatic Gain Switching](#) on page 8-69

### Gain Switching Combinations

Selected Gains	Speed Loop Gain	Speed Loop Integral Time Constant	Position Loop Gain	Torque Reference Filter	Model Following Control Gain	Model Following Control Correction	Friction Compensation Gain
Gain Settings 1	Speed Loop Gain (Pn100)	Speed Loop Integral Time Constant (Pn101)	Position Loop Gain (Pn102)	First Stage First Torque Reference Filter Time Constant (Pn401)	Model Following Control Gain* (Pn141)	Model Following Control Correction* (Pn142)	Friction Compensation Gain (Pn121)
Gain Settings 2	Second Speed Loop Gain (Pn104)	Second Speed Loop Integral Time Constant (Pn105)	Second Position Loop Gain (Pn106)	First Stage Second Torque Reference Filter Time Constant (Pn412)	Second Model Following Control Gain* (Pn148)	Second Model Following Control Correction* (Pn149)	Second Friction Compensation Gain (Pn122)

\* Gain switching for the model following control gain and the model following control gain correction is applicable only to manual gain switching.

To enable gain switching with these parameters, a gain switching input signal must be used and the following conditions must be met. If the conditions are not met, these parameters will not be changed even if the other parameters in the above table are changed.

- There must be no reference.
- The motor must be stopped.

## Manual Gain Switching

With manual gain switching, you use G-SEL in the servo command output signals (SVCMD\_IO) to change between gain settings 1 and gain settings 2.

Type	Command Name	Value	Meaning
Input	G-SEL in the servo command output signals (SVCMD_IO)	0	Changes the gain settings to gain settings 1.
		1	Changes the gain settings to gain settings 2.

## Automatic Gain Switching

Automatic gain switching is enabled only for position control. The switching conditions are specified by using the following settings.

Parameter	Switching Condition	Selected Gains	Switching Waiting Time	Switching Time
Pn139	n.□□□2	Gain settings 1 to gain settings 2	Gain Switching Waiting Time 1 Pn135	Gain Switching Time 1 Pn131
	Condition A not satisfied	Gain settings 2 to gain settings 1	Gain Switching Waiting Time 2 Pn136	Gain Switching Time 2 Pn132

Select one of the following settings for switching condition A.

Parameter	Position Control Gain Switching Condition A	For Control Methods Other Than Position Control (No Switching)	When Enabled	Classification	
Pn139	n.□□0□ (default setting)	/COIN (Positioning Completion) signal ON	Gain settings 1 used.	Immediately	Tuning
	n.□□1□	/COIN (Positioning Completion) signal OFF	Gain settings 2 used.		
	n.□□2□	/NEAR (Near) signal ON	Gain settings 1 used.		
	n.□□3□	/NEAR (Near) signal OFF	Gain settings 2 used.		
	n.□□4□	Position reference filter output is 0 and position reference input is OFF.	Gain settings 1 used.		
	n.□□5□	Position reference input is ON.	Gain settings 2 used.		

Automatic Switching Pattern 1 (Pn139 = n.□□□2)

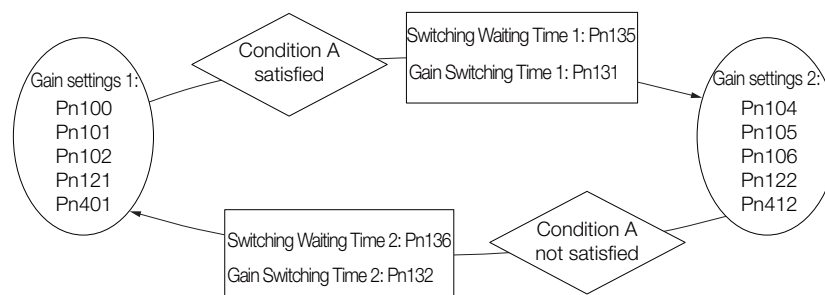

### ◆ Relationship between the Waiting Times and Switching Times for Gain Switching

In this example, an ON /COIN (Positioning Completion) signal is set as condition A for automatic gain switching. The position loop gain is changed from the value in Pn102 (Position Loop Gain) to the value in Pn106 (Second Position Loop Gain). When the /COIN signal turns ON, the switching operation begins after the waiting time (Pn135). The switching operation changes the position loop gain linearly from the gain set in Pn102 to the gain set in Pn106 over the switching time (Pn131).

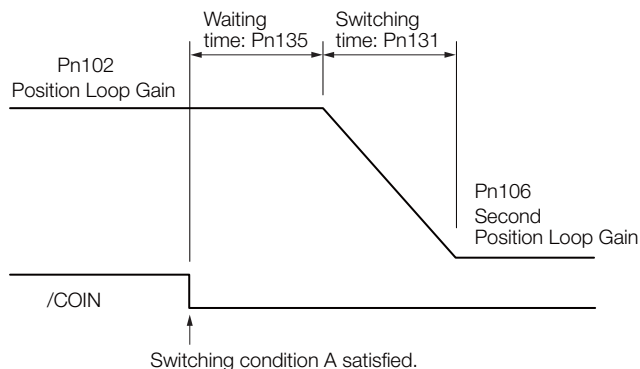

**Information** You can use gain switching for either PI control or I-P control (Pn10B = n.□□0□ or □□1□).

## Related Parameters

Pn100	Speed Loop Gain			Speed	Position	
	Setting Range	Setting Unit	Default Setting	When Enabled	Classification	
	10 to 20,000	0.1 Hz	400	Immediately	Tuning	
Pn101	Speed Loop Integral Time Constant			Speed	Position	
	Setting Range	Setting Unit	Default Setting	When Enabled	Classification	
	15 to 51,200	0.01 ms	2,000	Immediately	Tuning	
Pn102	Position Loop Gain				Position	
	Setting Range	Setting Unit	Default Setting	When Enabled	Classification	
	10 to 20,000	0.1/s	400	Immediately	Tuning	
Pn401	First Stage First Torque Reference Filter Time Constant			Speed	Position	Torque
	Setting Range	Setting Unit	Default Setting	When Enabled	Classification	
	0 to 65,535	0.01 ms	100	Immediately	Tuning	
Pn141	Model Following Control Gain				Position	
	Setting Range	Setting Unit	Default Setting	When Enabled	Classification	
	10 to 20,000	0.1/s	500	Immediately	Tuning	
Pn142	Model Following Control Correction				Position	
	Setting Range	Setting Unit	Default Setting	When Enabled	Classification	
	500 to 2,000	0.1%	1,000	Immediately	Tuning	
Pn121	Friction Compensation Gain			Speed	Position	
	Setting Range	Setting Unit	Default Setting	When Enabled	Classification	
	10 to 1,000	1%	100	Immediately	Tuning	
Pn104	Second Speed Loop Gain			Speed	Position	
	Setting Range	Setting Unit	Default Setting	When Enabled	Classification	
	10 to 20,000	0.1 Hz	400	Immediately	Tuning	
Pn105	Second Speed Loop Integral Time Constant			Speed	Position	
	Setting Range	Setting Unit	Default Setting	When Enabled	Classification	
	15 to 51,200	0.01 ms	2,000	Immediately	Tuning	
Pn106	Second Position Loop Gain				Position	
	Setting Range	Setting Unit	Default Setting	When Enabled	Classification	
	10 to 20,000	0.1/s	400	Immediately	Tuning	
Pn412	First Stage Second Torque Reference Filter Time Constant			Speed	Position	Torque
	Setting Range	Setting Unit	Default Setting	When Enabled	Classification	
	0 to 65,535	0.01 ms	100	Immediately	Tuning	
Pn148	Second Model Following Control Gain				Position	
	Setting Range	Setting Unit	Default Setting	When Enabled	Classification	
	10 to 20,000	0.1/s	500	Immediately	Tuning	

Continued on next page.

Continued from previous page.

Pn149	Second Model Following Control Correction				Position
	Setting Range	Setting Unit	Default Setting	When Enabled	Classification
	500 to 2,000	0.1%	1,000	Immediately	Tuning
Pn122	Second Friction Compensation Gain				Speed Position
	Setting Range	Setting Unit	Default Setting	When Enabled	Classification
	10 to 1,000	1%	100	Immediately	Tuning

## Parameters Related to Automatic Gain Switching

Pn131	Gain Switching Time 1				Position
	Setting Range	Setting Unit	Default Setting	When Enabled	Classification
	0 to 65,535	1 ms	0	Immediately	Tuning
Pn132	Gain Switching Time 2				Position
	Setting Range	Setting Unit	Default Setting	When Enabled	Classification
	0 to 65,535	1 ms	0	Immediately	Tuning
Pn135	Gain Switching Waiting Time 1				Position
	Setting Range	Setting Unit	Default Setting	When Enabled	Classification
	0 to 65,535	1 ms	0	Immediately	Tuning
Pn136	Gain Switching Waiting Time 2				Position
	Setting Range	Setting Unit	Default Setting	When Enabled	Classification
	0 to 65,535	1 ms	0	Immediately	Tuning

## Related Monitoring

- SigmaWin+  
You can monitor gain switching with the status monitor or with tracing.
- Analog Monitors

Parameter	Analog Monitor	Monitor Name	Output Value	Description
Pn006	n.□□0B	Active Gain Monitor	1 V	Gain settings 1 are enabled.
Pn007			2 V	Gain settings 2 are enabled.



## 8.12.2 Friction Compensation

Friction compensation is used to compensate for viscous friction fluctuations and regular load fluctuations.

You can automatically adjust friction compensation with autotuning without a host reference, autotuning with a host reference, or custom tuning, or you can manually adjust it with the following procedure.

### Required Parameter Settings

The following parameter settings are required to use friction compensation.

Parameter	Function			When Enabled	Classification	
Pn408	n.0□□□ (default setting)	Disable friction compensation.			Immediately	Setup
	n.1□□□	Enable friction compensation.				
Pn121	Friction Compensation Gain				<input type="checkbox"/> Speed	<input type="checkbox"/> Position
	Setting Range	Setting Unit	Default Setting	When Enabled	Classification	
	10 to 1,000	1%	100	Immediately	Tuning	
Pn122	Second Friction Compensation Gain				<input type="checkbox"/> Speed	<input type="checkbox"/> Position
	Setting Range	Setting Unit	Default Setting	When Enabled	Classification	
	10 to 1,000	1%	100	Immediately	Tuning	
Pn123	Friction Compensation Coefficient				<input type="checkbox"/> Speed	<input type="checkbox"/> Position
	Setting Range	Setting Unit	Default Setting	When Enabled	Classification	
	0 to 100	1%	0	Immediately	Tuning	
Pn124	Friction Compensation Frequency Correction				<input type="checkbox"/> Speed	<input type="checkbox"/> Position
	Setting Range	Setting Unit	Default Setting	When Enabled	Classification	
	-10,000 to 10,000	0.1 Hz	0	Immediately	Tuning	
Pn125	Friction Compensation Gain Correction				<input type="checkbox"/> Speed	<input type="checkbox"/> Position
	Setting Range	Setting Unit	Default Setting	When Enabled	Classification	
	1 to 1,000	1%	100	Immediately	Tuning	

## Operating Procedure for Friction Compensation

Use the following procedure to perform friction compensation.

### ⚠ CAUTION

- Before you execute friction compensation, set the moment of inertia ratio (Pn103) as accurately as possible. If the setting greatly differs from the actual moment of inertia, vibration may occur.

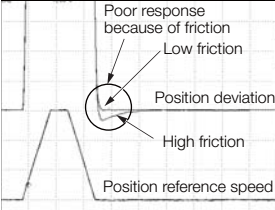
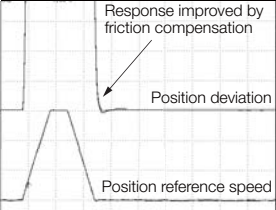
Step	Operation
1	<p>Set the following parameters related to friction compensation to their default settings.</p> <p>Friction compensation gain (Pn121): 100            Second friction compensation gain (Pn122): 100            Friction compensation coefficient (Pn123): 0            Friction compensation frequency correction (Pn124): 0            Friction compensation gain correction (Pn125): 100</p> <p>Note: Always use the default settings for the friction compensation frequency correction (Pn124) and friction compensation gain correction (Pn125).</p>
2	<p>Gradually increase the friction compensation coefficient (Pn123) to check the effect of friction compensation.</p> <p>Note: Usually, set the friction compensation coefficient (Pn123) to 95% or less.            If the effect is insufficient, increase the friction compensation gain (Pn121) by 10% increments until vibration stops.</p> <p><b>Effect of Adjusted Parameters</b></p> <p>Pn121: Friction Compensation Gain and Pn122: Second Friction Compensation Gain            These parameters set the response to external disturbances. The higher the setting is, the better the response will be. If the machine has a resonance frequency, however, vibration may occur if the setting is too high.</p> <p>Pn123: Friction Compensation Coefficient            This parameter sets the effect of friction compensation. The higher the setting is, the more effective friction compensation will be. If the setting is too high, however, vibration will occur more easily. Usually, set the value to 95% or less.</p>
3	<p><b>Effect of Adjustments</b></p> <p>The following graphs show the response with and without adjustment.</p> <div style="display: flex; justify-content: space-around; align-items: center;"> <div style="text-align: center;">  <p>Before Friction Compensation</p> </div> <div style="font-size: 2em;">⇒</div> <div style="text-align: center;">  <p>After Friction Compensation</p> </div> </div>

## 8.12.3 Gravity Compensation

When the Servomotor is used with a vertical axis, gravity compensation prevents the moving part from falling due to the machine's own weight when the brake is released.

SERVOPACKs with software version 0023 or higher support gravity compensation.

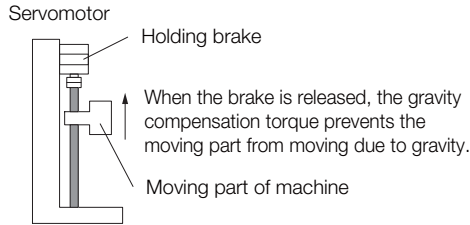

A timing chart for when the moving part is raised then lowered is provided below.

Refer to the following section for details on brake operation timing.

5.12.1 Brake Operating Sequence on page 5-33

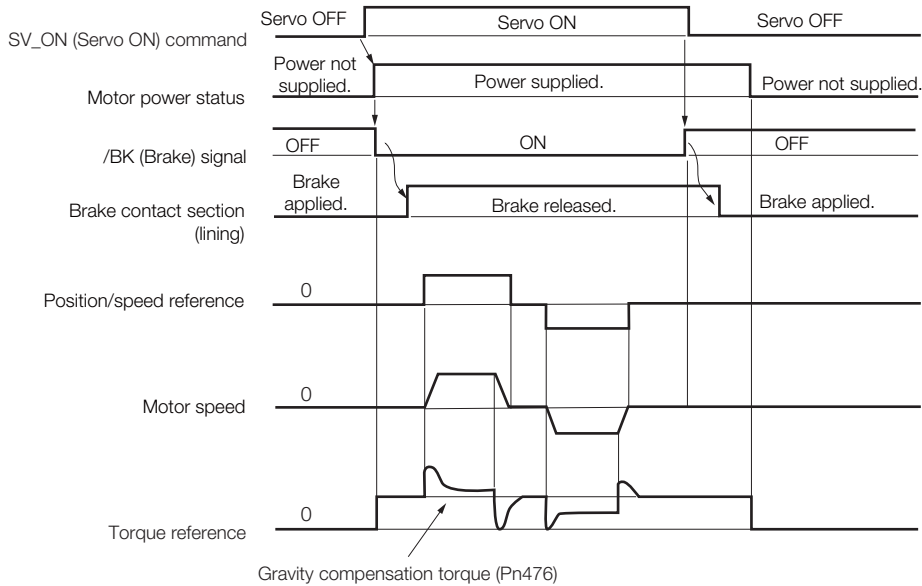

### Required Parameter Settings

The following parameter settings are required to use gravity compensation.

Parameter	Description	When Enabled	Classification		
Pn475	n.□□□0 (default setting)	After restart	Setup		
	n.□□□1			Enable gravity compensation.	
Pn476	Gravity Compensation Torque		Speed   Position   Torque		
	Setting Range	Setting Unit	Default Setting	When Enabled	Classification
	-1,000 to 1,000	0.1%	0	Immediately	Tuning

## Operating Procedure for Gravity Compensation

Use the following procedure to perform gravity compensation.

1. Set Pn475 to n.□□□1 (Enable gravity compensation).
2. To enable changes to the settings, turn the power supply to the SERVOPACK OFF and ON again.
3. Use SigmaWin+ or an analog monitor to find the torque reference value when the motor is stopped with the servo ON.
4. Set the torque reference value found in step 3 in Pn476 (Gravity Compensation Torque).
5. Turn the servo ON and OFF a few times and fine-tune Pn476 so that the moving part of the machine does not fall.

## 8.12.4 Current Control Mode Selection

Current control mode selection reduces high-frequency noise while the Servomotor is being stopped.

To use current control mode selection, use current control mode 2 (set Pn009 to n.□□2□).

Parameter		Meaning	When Enabled	Classification
Pn009	n. □□0□	Use current control mode 1.	After restart	Tuning
	n. □□1□ (default setting)			
	n. □□2□	Use current control mode 2 (low noise).		



If current control mode 2 is selected, the load ratio may increase while the Servomotor is being stopped.

Important

## 8.12.5 Current Gain Level Setting

You can set the current gain level to reduce noise by adjusting the parameter for current control inside the SERVOPACK according to the speed loop gain (Pn100). The noise level can be reduced by decreasing the current gain level (Pn13D) from its default setting of 2,000% (disabled). However, if the setting is decreased, the level of noise will be lowered, but the response characteristic of the SERVOPACK will also be reduced. Adjust the current gain level within the range that maintains the SERVOPACK response characteristic.

Pn13D	Current Gain Level				[Speed]	[Position]
	Setting Range	Setting Unit	Default Setting	When Enabled	Classification	
	100 to 2,000	1%	2,000	Immediately	Tuning	



If the current gain level is changed, the response characteristic of the speed loop will also change. Servo tuning must therefore be performed again.

Important

## 8.12.6 Speed Detection Method Selection

You can use the speed detection method selection to ensure smooth Servomotor speed changes during operation. To ensure smooth motor speed changes during operation, set Pn009 to n.□0□□ (Use speed detection 1).

With a Linear Servomotor, you can reduce the noise level of the running motor when the linear encoder scale pitch is large.

Parameter	Meaning	When Enabled	Classification
Pn009	n. □0□□ (default setting)	After restart	Tuning
	n. □1□□		



**Important** If the speed detection method is changed, the response characteristic of the speed loop will also change. Servo tuning must therefore be performed again.

## 8.12.7 Speed Feedback Filter

You can set a first order lag filter for the speed feedback in the speed loop. This ensures smooth changes in the feedback speed to reduce vibration. If a large value is set, it will increase the delay and make response slower.

Pn308	Speed Feedback Filter Time Constant			Speed	Position
	Setting Range	Setting Unit	Default Setting	When Enabled	Classification
	0 to 65,535 (0.00 ms to 655.35 ms)	0.01 ms	0 (0.00 ms)	Immediately	Setup

## 8.12.8 Backlash Compensation

### Outline

If you drive a machine that has backlash, there will be deviation between the travel distance in the position reference that is managed by the host controller and the travel distance of the actual machine. Use backlash compensation to add the backlash compensation value to the position reference and use the result to drive the Servomotor. This will ensure that the travel distance of the actual machine will be the same as the travel distance in the host controller.

- Note: 1. Backlash compensation can be used only with a Rotary Servomotor.  
 2. Backlash compensation can be used only for position control.

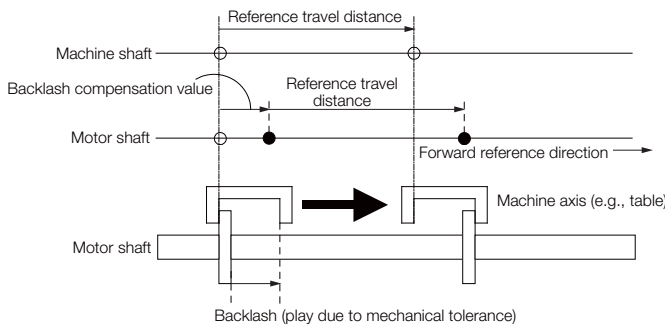

## Related Parameters

Set the following parameters to use backlash compensation.

### ◆ Backlash Compensation Direction

Set the direction in which to apply backlash compensation.

Parameter	Meaning	When Enabled	Classification
Pn230	n. □□□0 (default setting)	After restart	Setup
	n. □□□1		

### ◆ Backlash Compensation Value

Set the amount of backlash compensation to add to the position reference.

The amount is set in increments of 0.1 reference unit. However, when the amount is converted to encoder pulses, it is rounded off at the decimal point.

**Example** When Pn231 = 6,553.6 [reference units] and electronic gear ratio (Pn20E/Pn210) = 4/1:  
 $6,553.6 \times 4 = 26,214.4$  [pulses]  
 $\Rightarrow$  The backlash compensation will be 26,214 encoder pulses.

Pn231	Backlash Compensation				
	Position				
	Setting Range	Setting Unit	Default Setting	When Enabled	Classification
	-500,000 to 500,000	0.1 reference units	0	Immediately	Setup



Important

- The backlash compensation value is restricted by the following formula. Backlash compensation is not performed if this condition is not met.

$$Pn231 \leq \frac{Pn210}{Pn20E} \times \frac{\text{Maximum motor speed [min}^{-1}\text{]}}{60} \times \text{Encoder resolution} \times 0.00025$$

\*Refer to the following section for the encoder resolution.

5.15 Electronic Gear Settings on page 5-43

Pn20E = 4, Pn210 = 1, Maximum motor speed = 6,000 [min<sup>-1</sup>], and Encoder resolution = 16,777,216 (24 bits)

$$1/4 \times 6,000/60 \times 16,777,216 \times 0.00025 = 104,857.6 \text{ [reference units]}$$

$\Rightarrow$  The backlash compensation will be limited to 104,857.6 reference units.

- Do not exceed the upper limit of the backlash compensation value. You can check the upper limit on the operation monitor of the SigmaWin+.

### ◆ Backlash Compensation Time Constant

You can set a time constant for a first order lag filter for the backlash compensation value (Pn231) that is added to the position reference.

If you set Pn233 (Backlash Compensation Time Constant) to 0, the first order lag filter is disabled.

Pn233	Backlash Compensation Time Constant				
	Position				
	Setting Range	Setting Unit	Default Setting	When Enabled	Classification
	0 to 65,535	0.01 ms	0	Immediately	Setup

Note: Changes to the settings are applied when there is no reference pulse input and the Servomotor is stopped. The current operation is not affected if the setting is changed during Servomotor operation.

## Related Monitoring

You can monitor the following values on the operation monitor of the SigmaWin+.

Displayed Value	Setting Unit
Current Backlash Compensation Value	0.1 reference units
Backlash Compensation Value Setting Limit	0.1 reference units

## Compensation Operation

This section describes the operation that is performed for backlash compensation.

Note: The following figures are for when backlash compensation is applied to references in the forward direction (Pn230 = n.□□□0). The following monitor information is provided in the figures: TPOS (target position in the reference coordinate system), POS (reference position in the reference coordinate system), and APOS (feedback position in the machine coordinate system). The monitor information includes the feedback position in machine coordinate system (APOS) and other feedback information.

The backlash compensation value is subtracted from the feedback positions in the monitor information, so it is not necessary for the host controller to consider the backlash compensation value.

### ◆ Operation When the Servo Is ON

The backlash compensation value (Pn231) is added in the backlash compensation direction when the servo is ON (i.e., while power is supplied to the motor) and a reference is input in the same direction as the backlash compensation direction (Pn230 = n.□□□X).

When there is a reference input in the direction opposite to the backlash compensation direction, the backlash compensation value is not added (i.e., backlash compensation is not performed).

The relationship between APOS and the motor shaft position is as follows:

- If a reference is input in the compensation direction:  $APOS = \text{Motor shaft position} - Pn231$
- If a reference is input in the direction opposite to the compensation direction:  $APOS = \text{Motor shaft position}$

The following figure shows driving the Servomotor in the forward direction from target position TPOS0 to TPOS1 and then to TPOS2, and then returning from TPOS2 to TPOS1 and then to TPOS0.

Backlash compensation is applied when moving from TPOS0 to TPOS1, but not when moving from TPOS2 to TPOS1.

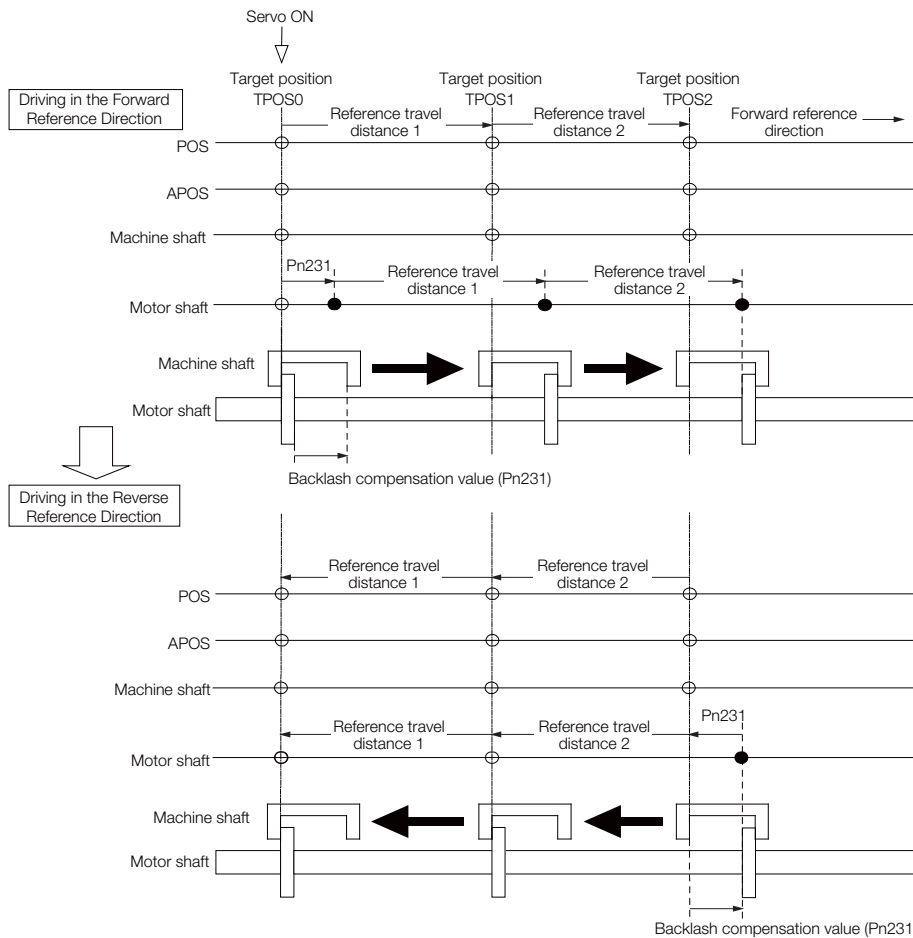

### ◆ Operation When the Servo Is OFF

Backlash compensation is not applied when the servo is OFF (i.e., when power is not supplied to motor). Therefore, the reference position POS is moved by only the backlash compensation value.

The relationship between APOS and the motor shaft position is as follows:

- When servo is OFF:  $APOS = \text{Servomotor shaft position}$

The following figure shows what happens when the servo is turned OFF after driving the Servomotor in the forward direction from target position TPOS0 to TPOS1. Backlash compensation is not applied when the servo is OFF. (The SERVOPACK manages the position data so that APOS and POS are the same.)

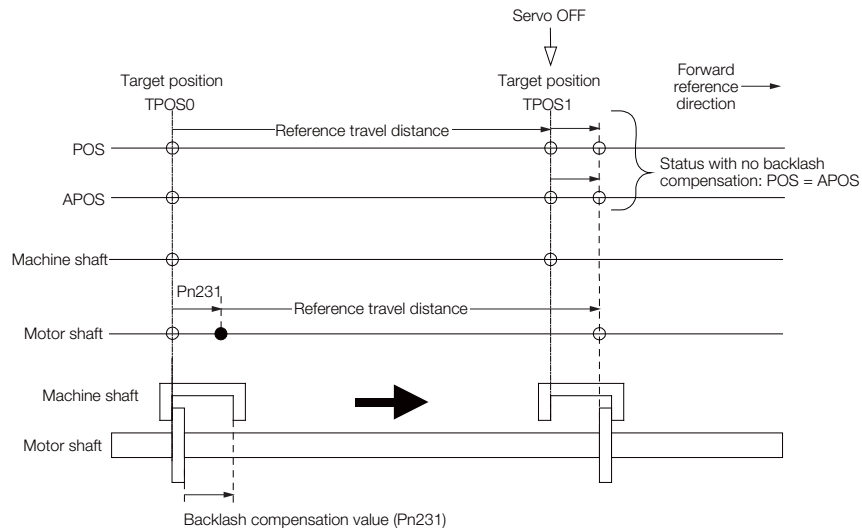

### ◆ Operation When There Is Overtravel

When there is overtravel (i.e., when driving is prohibited due to an overtravel signal or software limit), the operation is the same as for when the servo is OFF (◆ *Operation When the Servo Is OFF* on page 8-79), i.e., backlash compensation is not applied.

### ◆ Operation When Control Is Changed

Backlash compensation is performed only for position control.

Backlash compensation is not applied when position control is changed to any other control method.

Backlash compensation is applied in the same way as when the servo is ON (◆ *Operation When the Servo Is ON* on page 8-78) if any other control method is changed to position control.

## Related Monitoring

You can monitor the following values on the operation monitor of the SigmaWin+.

Displayed Value	Unit	Specification
Input Reference Pulse Speed	$\text{min}^{-1}$	Displays the input reference pulse speed before backlash compensation.
Position Deviation	Reference units	Displays the position deviation for the position reference after backlash compensation.
Input Reference Pulse Counter	Reference units	Displays the input reference pulse counter before backlash compensation.
Feedback Pulse Counter	Encoder pulses	Displays the number of pulses from the actually driven motor encoder.
Feedback Pulse Counter	Reference units	Displays the number of pulses from the actually driven encoder in reference units.



## MECHATROLINK Monitor Information

This section describes the information that is set for the MECHATROLINK monitor information (monitor 1, monitor 2, monitor 3, and monitor 4) and the backlash compensation operation.

Monitor Code	Abbreviation	Description	Unit	Remarks
0	POS	Reference position in the reference coordinate system (after the position reference filter)	Reference units	–
1	MPOS	Reference position	Reference units	–
2	PERR	Position deviation	Reference units	–
3	APOS	Feedback position in machine coordinate system	Reference units	Feedback position with the backlash compensation subtracted
4	LPOS	Feedback latch position in the machine coordinate system	Reference units	Feedback position with the backlash compensation subtracted
5	IPOS	Reference position in the reference coordinate system (before the position reference filter)	Reference units	–
6	TPOS	Target position in the reference coordinate system	Reference units	–
E	OMN1	Option monitor 1 (selected with Pn824)	–	–
F	OMN2	Option monitor 2 (selected with Pn825)	–	–

Parameter	Monitor Information	Output Unit	Remarks	
Pn824 Pn825	0003h	Position deviation (lower 32 bits)	Reference units	
	0004h	Position deviation (upper 32 bits)	Reference units	
	000Ah	PG count (lower 32 bits)	Reference units	Count value of the actually driven motor encoder
	000Bh	PG count (upper 32 bits)	Reference units	
	0017h	Input reference pulse speed	min <sup>-1</sup>	–
	0018h	Position deviation	Reference units	–
	001Ch	Input reference pulse counter	Reference units	–
	001Dh	Feedback pulse counter	Encoder pulses	–
	0080h	Previous value of latched feedback position (LPOS)	Encoder pulses	Feedback position with the backlash compensation subtracted

◆ Related Monitoring Diagrams

The following symbols are used in the related monitoring diagrams.

[A]: Analog monitor

[U]: Monitor mode (Un monitor)

[O]: Output signal

[T]: Trace data

[M]: MECHATROLINK monitor information

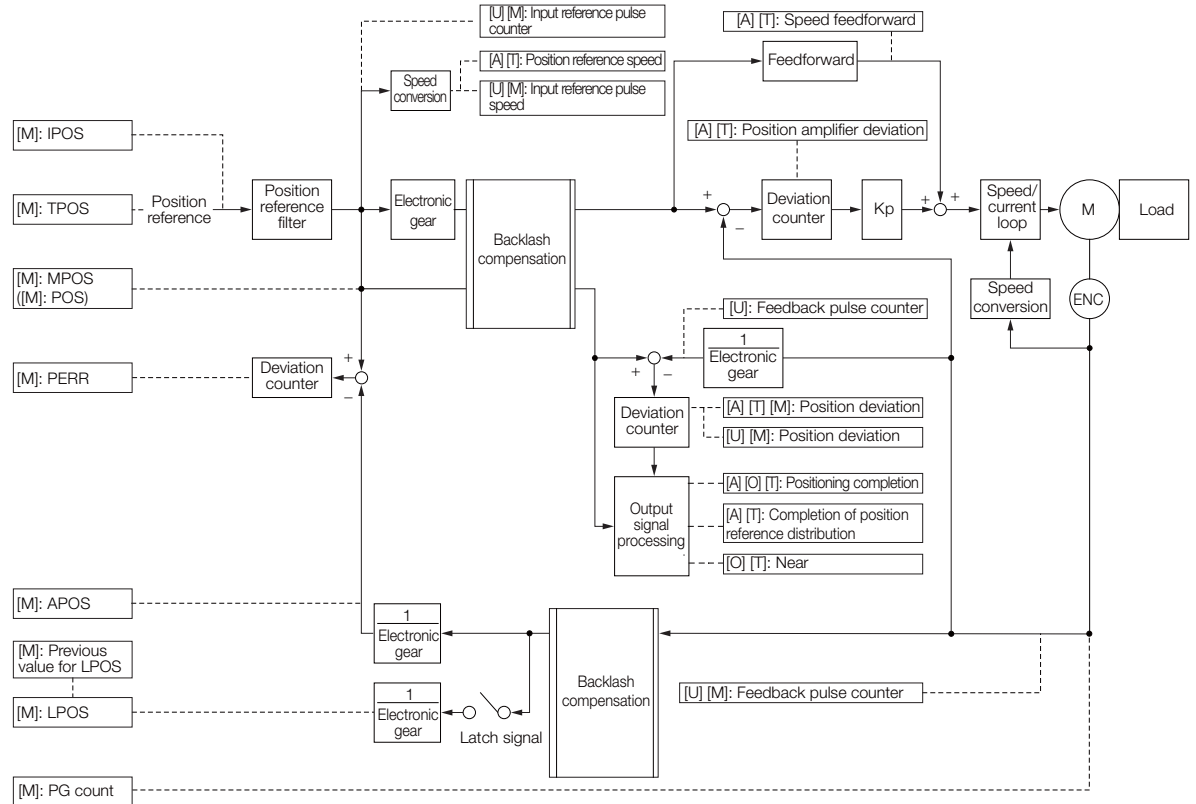

# 8.13 Manual Tuning

This section describes manual tuning.

## 8.13.1 Tuning the Servo Gains

### Servo Gains

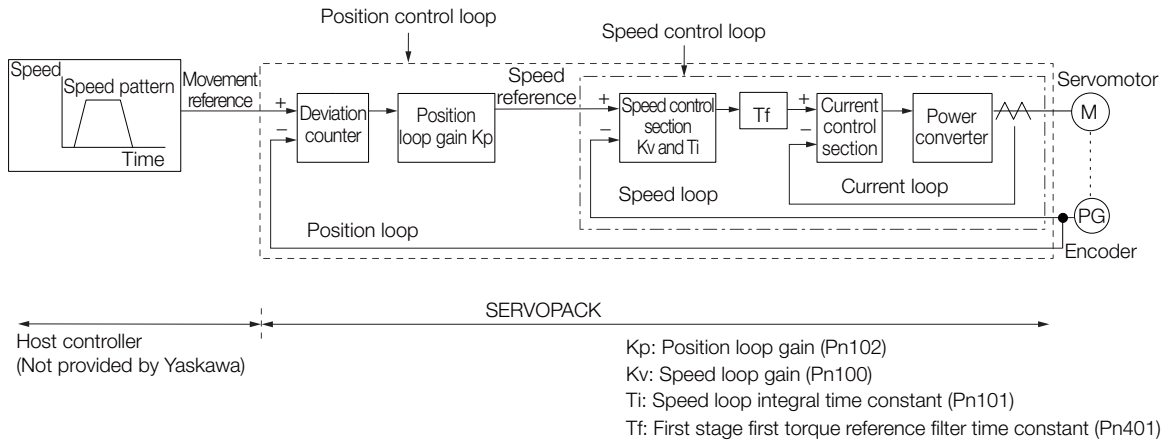

In order to manually tune the servo gains, you must understand the configuration and characteristic of the SERVOPACK and adjust the servo gains individually. In most cases, if you greatly change any one parameter, you must adjust the other parameters again. To check the response characteristic, you must prepare a measuring instrument to monitor the output waveforms from the analog monitor.

The SERVOPACK has three feedback systems (the position loop, speed loop, and current loop), and the response characteristic must be increased more with the inner loops. If this relationship is not maintained, the response characteristic will suffer and vibration will occur more easily.

A sufficient response characteristic is ensured for the current loop. There is never a need for it to be adjusted by the user.

### Outline

You can use manual tuning to set the servo gains in the SERVOPACK to increase the response characteristic of the SERVOPACK. For example, you can reduce the positioning time for position control.

Use manual tuning in the following cases.

- When tuning with autotuning without a host reference or autotuning with a host reference does not achieve the desired results
- When you want to increase the servo gains higher than the gains that resulted from autotuning without a host reference or autotuning with a host reference
- When you want to determine the servo gains and moment of inertia ratio yourself

You start manual tuning either from the default parameter settings or from the gain settings that resulted from autotuning without a host reference or autotuning with a host reference.

### Applicable Tools

You can monitor the servo gains with the SigmaWin+ or with the analog monitor.

## Precautions

Vibration may occur while you are tuning the servo gains. We recommend that you enable vibration alarms (Pn310 = n.□□□2) to detect vibration. Refer to the following section for information on vibration detection.

 6.10 *Initializing the Vibration Detection Level* on page 6-37

Vibration alarms are not detected for all vibration. Also, an emergency stop method is necessary to stop the machine safely when an alarm occurs. You must provide an emergency stop device and activate it immediately whenever vibration occurs.

## Tuning Procedure Example (for Position Control or Speed Control)

Step	Description
1	Adjust the first stage first torque reference filter time constant (Pn401) so that vibration does not occur.
2	Increase the position loop gain (Pn100) and reduce the speed loop integral time constant (Pn101) as far as possible within the range that does not cause machine vibration.
3	Repeat steps 1 and 2 and return the settings about 10% to 20% from the values that you set.
4	For position control, increase the position loop gain (Pn102) within the range that does not cause vibration.

### Information

If you greatly change any one servo gain parameter, you must adjust the other parameters again. Do not increase the setting of just one parameter. As a guideline, adjust the settings of the servo gains by approximately 5% each. As a rule, change the servo parameters in the following order.

- To Increase the Response Speed
  1. Reduce the torque reference filter time constant.
  2. Increase the speed loop gain.
  3. Decrease the speed loop integral time constant.
  4. Increase the position loop gain.
- To Reduce Response Speed and to Stop Vibration and Overshooting
  1. Reduce the position loop gain.
  2. Increase the speed loop integral time constant.
  3. Decrease the speed loop gain.
  4. Increase the torque filter time constant.

## Adjusted Servo Gains

You can set the following gains to adjust the response characteristic of the SERVOPACK.

- Pn100: Speed Loop Gain
- Pn101: Speed Loop Integral Time Constant
- Pn102: Position Loop Gain
- Pn401: First Stage First Torque Reference Filter Time Constant

### ◆ Position Loop Gain

The position loop gain determines the response characteristic of the position loop in the SERVOPACK. If you can increase the setting of the position loop gain, the response characteristic will improve and the positioning time will be shortened. However, you normally cannot increase the position loop gain higher than the inherent vibration frequency of the machine system. Therefore, to increase the setting of the position loop gain, you must increase the rigidity of the machine to increase the inherent vibration frequency of the machine.

Pn102	Position Loop Gain <span style="float:right">Position</span>				
	Setting Range	Setting Unit	Default Setting	When Enabled	Classification
	10 to 20,000	0.1/s	400	Immediately	Tuning

**Information** For machines for which a high position loop gain (Pn102) cannot be set, overflow alarms can occur during high-speed operation. If that is the case, you can increase the setting of the following parameter to increase the level for alarm detection. Use the following condition as a guideline for determining the setting.

$$Pn520 \geq \frac{\text{Maximum feed speed [reference units/s]}}{Pn102 \div 10 (1/s)} \times 2.0$$

If you use a position reference filter, transient deviation will increase due to the filter time constant. When you make the setting, consider deviation accumulation that may result from the filter.

Pn520	Position Deviation Overflow Alarm Level <span style="float:right">Position</span>				
	Setting Range	Setting Unit	Default Setting	When Enabled	Classification
	1 to 1,073,741,823	1 reference unit	5,242,880	Immediately	Setup

### ◆ Speed Loop Gain

This parameter determines the response characteristic of the speed loop. If the response characteristic of the speed loop is low, it becomes a delay factor for the position loop located outside of the speed loop. This will result in overshooting and vibration in the speed reference. Therefore, setting the speed loop gain as high as possible within the range that will not cause the machine system to vibrate will produce a stable servo system with a good response characteristic.

Pn100	Speed Loop Gain <span style="float:right">Speed</span> <span style="float:right">Position</span> <span style="float:right">Torque</span>				
	Setting Range	Setting Unit	Default Setting	When Enabled	Classification
	10 to 20,000	0.1 Hz	400	Immediately	Tuning

$$\text{Setting of Pn103} = \frac{\text{Load moment of inertia at motor shaft } (J_L)}{\text{Servomotor moment of inertia } (L_M)} \times 100(\%)$$

The default setting of Pn103 (Moment of Inertia Ratio) is 100. Before you tune the servo, calculate the moment of inertia ratio with the above formula and set Pn103 to the calculation result.

Pn103	Moment of Inertia Ratio <span style="float:right">Speed</span> <span style="float:right">Position</span> <span style="float:right">Torque</span>				
	Setting Range	Setting Unit	Default Setting	When Enabled	Classification
	0 to 20,000	1%	100	Immediately	Tuning

### ◆ Speed Loop Integral Time Constant

To enable response to even small inputs, the speed loop has an integral element. The integral element becomes a delay factor in the servo system. If the time constant is set too high, overshooting will occur, positioning settling time will increase, and the response characteristic will suffer.

Pn101	Speed Loop Integral Time Constant <span style="float:right">Speed</span> <span style="float:right">Position</span>				
	Setting Range	Setting Unit	Default Setting	When Enabled	Classification
	15 to 51,200	0.01 ms	2,000	Immediately	Tuning

## ◆ Torque Reference Filter

As shown in the following diagram, the torque reference filter contains a first order lag filter and notch filters arranged in series, and each filter operates independently.

The notch filters can be enabled and disabled with Pn408 = n.□X□X and Pn416 = n.□XXX.

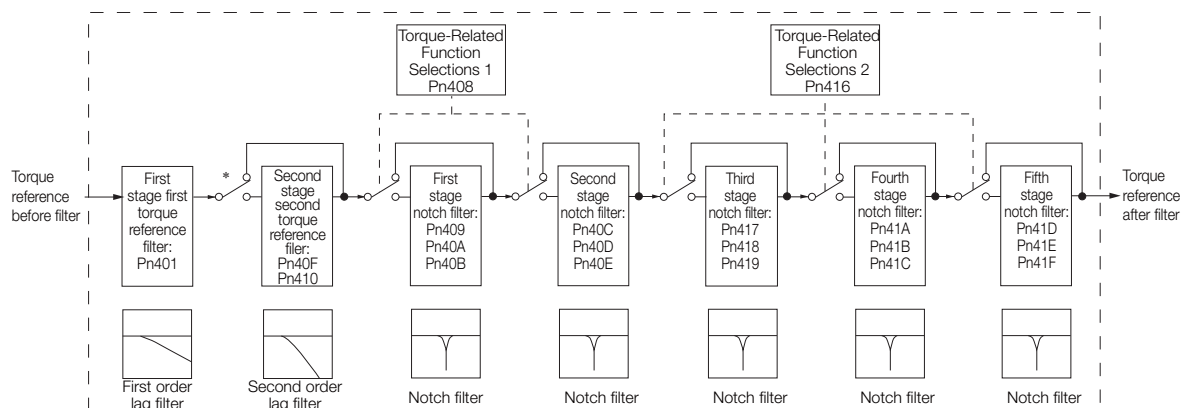

\* The second stage second torque reference filter is disabled when Pn40F is set to 5,000 (default setting) and it is enabled when Pn40F is set to a value lower than 5,000.

## ■ Torque Reference Filter

If you suspect that machine vibration is being caused by the Servo Drive, try adjusting the torque reference filter time constant. This may stop the vibration. The lower the value, the better the control response characteristic will be, but there may be a limit depending on the machine conditions.

Pn401	First Stage First Torque Reference Filter Time Constant			Speed	Position	Torque
	Setting Range	Setting Unit	Default Setting	When Enabled	Classification	
	0 to 65,535	0.01 ms	100	Immediately	Tuning	
Pn40F	Second Stage Second Torque Reference Filter Frequency			Speed	Position	Torque
	Setting Range	Setting Unit	Default Setting	When Enabled	Classification	
	100 to 5,000	1 Hz	5,000*	Immediately	Tuning	
Pn410	Second Stage Second Notch Filter Q Value			Speed	Position	Torque
	Setting Range	Setting Unit	Default Setting	When Enabled	Classification	
	50 to 100	0.01	50	Immediately	Tuning	

\* The filter is disabled if you set the parameter to 5,000.

## ■ Notch Filters

The notch filter can eliminate specific frequency elements generated by the vibration of sources such as resonance of the shaft of a ball screw.

The notch filter puts a notch in the gain curve at the specific vibration frequency (called the notch frequency). The frequency components near the notch frequency can be reduced or removed with a notch filter.

Notch filters are set with three parameters for the notch filter frequency, notch filter Q value, and notch filter depth. This section describes the notch filter Q value and notch filter depth.

### • Notch filter Q Value

The setting of the notch filter Q value determines the width of the frequencies that are filtered for the notch filter frequency. The width of the notch changes with the notch filter Q value. The larger the notch filter Q value is, the steeper the notch is and the narrower the width of frequencies that are filtered is.

The notch filter frequency characteristics for different notch filter Q values are shown below.

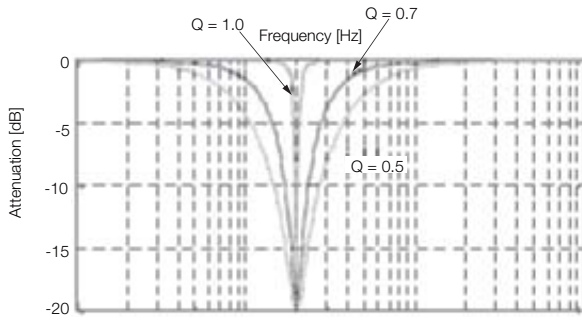

Note: The above notch filter frequency characteristics are based on calculated values and may be different from actual characteristics.

• Notch Filter Depth

The setting of the notch filter depth determines the depth of the frequencies that are filtered for the notch filter frequency. The depth of the notch changes with the notch filter depth. The smaller the notch filter depth is, the deeper the notch is, increasing the effect of vibration suppression. However, if the value is too small, vibration can actually increase.

The notch filter is disabled if the notch filter depth, d, is set to 1.0 (i.e., if Pn419 is set to 1,000).

The notch filter frequency characteristics for different notch filter depths are shown below.

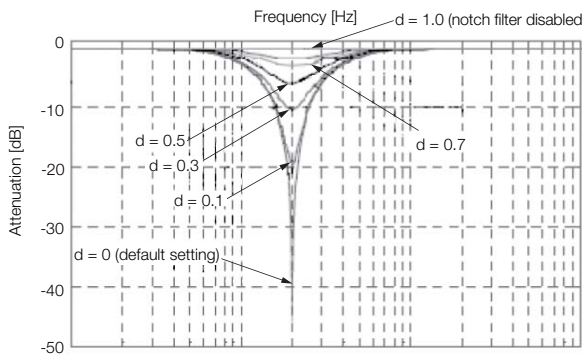

Note: The above notch filter frequency characteristics are based on calculated values and may be different from actual characteristics.

You can enable or disable the notch filter with Pn408 and Pn416.

	Parameter	Meaning	When Enabled	Classification
Pn408	n.□□□0 (default setting)	Disable first stage notch filter.	Immediately	Setup
	n.□□□1	Enable first stage notch filter.		
	n.□0□□ (default setting)	Disable second stage notch filter.		
	n.□1□□	Enable second stage notch filter.		
Pn416	n.□□□0 (default setting)	Disable third stage notch filter.		
	n.□□□1	Enable third stage notch filter.		
	n.□□0□ (default setting)	Disable fourth stage notch filter.		
	n.□□1□	Enable fourth stage notch filter.		
	n.□0□□ (default setting)	Disable fifth stage notch filter.		
	n.□1□□	Enable fifth stage notch filter.		

Set the machine vibration frequencies in the notch filter parameters.

Pn409	First Stage Notch Filter Frequency			<input type="checkbox"/> Speed	<input type="checkbox"/> Position	<input type="checkbox"/> Torque
	Setting Range	Setting Unit	Default Setting	When Enabled	Classification	
	50 to 5,000	1 Hz	5,000	Immediately	Tuning	
Pn40A	First Stage Notch Filter Q Value			<input type="checkbox"/> Speed	<input type="checkbox"/> Position	<input type="checkbox"/> Torque
	Setting Range	Setting Unit	Default Setting	When Enabled	Classification	
	50 to 1,000	0.01	70	Immediately	Tuning	
Pn40B	First Stage Notch Filter Depth			<input type="checkbox"/> Speed	<input type="checkbox"/> Position	<input type="checkbox"/> Torque
	Setting Range	Setting Unit	Default Setting	When Enabled	Classification	
	0 to 1,000	0.001	0	Immediately	Tuning	
Pn40C	Second Stage Notch Filter Frequency			<input type="checkbox"/> Speed	<input type="checkbox"/> Position	<input type="checkbox"/> Torque
	Setting Range	Setting Unit	Default Setting	When Enabled	Classification	
	50 to 5,000	1 Hz	5,000	Immediately	Tuning	
Pn40D	Second Stage Notch Filter Q Value			<input type="checkbox"/> Speed	<input type="checkbox"/> Position	<input type="checkbox"/> Torque
	Setting Range	Setting Unit	Default Setting	When Enabled	Classification	
	50 to 1,000	0.01	70	Immediately	Tuning	
Pn40E	Second Stage Notch Filter Depth			<input type="checkbox"/> Speed	<input type="checkbox"/> Position	<input type="checkbox"/> Torque
	Setting Range	Setting Unit	Default Setting	When Enabled	Classification	
	0 to 1,000	0.001	0	Immediately	Tuning	
Pn417	Third Stage Notch Filter Frequency			<input type="checkbox"/> Speed	<input type="checkbox"/> Position	<input type="checkbox"/> Torque
	Setting Range	Setting Unit	Default Setting	When Enabled	Classification	
	50 to 5,000	1 Hz	5,000	Immediately	Tuning	
Pn418	Third Stage Notch Filter Q Value			<input type="checkbox"/> Speed	<input type="checkbox"/> Position	<input type="checkbox"/> Torque
	Setting Range	Setting Unit	Default Setting	When Enabled	Classification	
	50 to 1,000	0.01	70	Immediately	Tuning	
Pn419	Third Stage Notch Filter Depth			<input type="checkbox"/> Speed	<input type="checkbox"/> Position	<input type="checkbox"/> Torque
	Setting Range	Setting Unit	Default Setting	When Enabled	Classification	
	0 to 1,000	0.001	0	Immediately	Tuning	
Pn41A	Fourth Stage Notch Filter Frequency			<input type="checkbox"/> Speed	<input type="checkbox"/> Position	<input type="checkbox"/> Torque
	Setting Range	Setting Unit	Default Setting	When Enabled	Classification	
	50 to 5,000	1 Hz	5,000	Immediately	Tuning	
Pn41B	Fourth Stage Notch Filter Q Value			<input type="checkbox"/> Speed	<input type="checkbox"/> Position	<input type="checkbox"/> Torque
	Setting Range	Setting Unit	Default Setting	When Enabled	Classification	
	50 to 1,000	0.01	70	Immediately	Tuning	
Pn41C	Fourth Stage Notch Filter Depth			<input type="checkbox"/> Speed	<input type="checkbox"/> Position	<input type="checkbox"/> Torque
	Setting Range	Setting Unit	Default Setting	When Enabled	Classification	
	0 to 1,000	0.001	0	Immediately	Tuning	
Pn41D	Fifth Stage Notch Filter Frequency			<input type="checkbox"/> Speed	<input type="checkbox"/> Position	<input type="checkbox"/> Torque
	Setting Range	Setting Unit	Default Setting	When Enabled	Classification	
	50 to 5,000	1 Hz	5,000	Immediately	Tuning	
Pn41E	Fifth Stage Notch Filter Q Value			<input type="checkbox"/> Speed	<input type="checkbox"/> Position	<input type="checkbox"/> Torque
	Setting Range	Setting Unit	Default Setting	When Enabled	Classification	
	50 to 1,000	0.01	70	Immediately	Tuning	
Pn41F	Fifth Stage Notch Filter Depth			<input type="checkbox"/> Speed	<input type="checkbox"/> Position	<input type="checkbox"/> Torque
	Setting Range	Setting Unit	Default Setting	When Enabled	Classification	
	0 to 1,000	0.001	0	Immediately	Tuning	





- Do not set notch filter frequencies (Pn409, Pn40C, Pn417, Pn41A, and Pn41D) that are close to the speed loop's response frequency. Set a frequency that is at least four times the speed loop gain (Pn100). (However, Pn103 (Moment of Inertia Ratio) must be set correctly. If the setting is not correct, vibration may occur and the machine may be damaged.
- Change the notch filter frequencies (Pn409, Pn40C, Pn417, Pn41A, and Pn41D) only while the Servomotor is stopped. Vibration may occur if a notch filter frequency is changed during operation.

## Guidelines for Manually Tuning Servo Gains

When you manually adjust the parameters, make sure that you completely understand the information in the product manual and use the following conditional expressions as guidelines. The appropriate values of the parameter settings are influenced by the machine specifications, so they cannot be determined universally. When you adjust the parameters, actually operate the machine and use the SigmaWin+ or analog monitor to monitor operating conditions. Even if the status is stable while the Servomotor is stopped, an unstable condition may occur when an operation reference is input. Therefore, input operation references and adjust the servo gains as you operate the Servomotor.

**Stable gain:** Settings that provide a good balance between parameters.

However, if the load moment of inertia is large and the machine system contains elements prone to vibration, you must sometimes use a setting that is somewhat higher to prevent the machine from vibrating.

**Critical gain:** Settings for which the parameters affect each other

Depending on the machine conditions, overshooting and vibration may occur and operation may not be stable. If the critical gain condition expressions are not met, operation will become more unstable, and there is a risk of abnormal motor shaft vibration and round-trip operation with a large amplitude. Always stay within the critical gain conditions.

If you use the torque reference filter, second torque reference filter, and notch filters together, the interference between the filters and the speed loop gain will be superimposed. Allow leeway in the adjustments.



The following adjusted value guidelines require that the setting of Pn103 (Moment of Inertia Ratio) is correctly set for the actual machine.

### ◆ When Pn10B = n.□□0□ (PI Control )

Guidelines are given below for gain settings 1.

The same guidelines apply to gain settings 2 (Pn104, Pn105, Pn106, and Pn412).

- Speed Loop Gain (Pn100 [Hz]) and Position Loop Gain (Pn102 [/s])
  - Stable gain:  $Pn102 [s] \leq 2\pi \times Pn100/4 [Hz]$
  - Critical gain:  $Pn102 [s] < 2\pi \times Pn100 [Hz]$
  
- Speed Loop Gain (Pn100 [Hz]) and Speed Loop Integral Time Constant (Pn101 [ms])
  - Stable gain:  $Pn101 [ms] \geq 4,000/(2\pi \times Pn100 [Hz])$
  - Critical gain:  $Pn101 [ms] > 1,000/(2\pi \times Pn100 [Hz])$
  
- Speed Loop Gain (Pn100 [Hz]) and First Stage First Torque Reference Filter Time Constant (Pn401 [ms])
  - Stable gain:  $Pn401 [ms] \leq 1,000/(2\pi \times Pn100 [Hz] \times 4)$
  - Critical gain:  $Pn401 [ms] < 1,000/(2\pi \times Pn100 [Hz] \times 1)$

- Speed Loop Gain (Pn100 [Hz]) and Second Stage Second Torque Reference Filter Frequency (Pn40F [Hz])  
Critical gain:  $Pn40F [Hz] > 4 \times Pn100 [Hz]$   
Note: Set the second stage second notch filter Q value (Pn410) to 0.70.
- Speed Loop Gain (Pn100 [Hz]) and First Stage Notch Filter Frequency (Pn409 [Hz]) (or Second Stage Notch Filter Frequency (Pn40C [Hz]))  
Critical gain:  $Pn409 [Hz] > 4 \times Pn100 [Hz]$
- Speed Loop Gain (Pn100 [Hz]) and Speed Feedback Filter Time Constant (Pn308 [ms])  
Stable gain:  $Pn308 [ms] \leq 1,000 / (2\pi \times Pn100 [Hz] \times 4)$   
Critical gain:  $Pn308 [ms] < 1,000 / (2\pi \times Pn100 [Hz] \times 1)$

### ◆ When Pn10B = n.□□1□ (I-P Control)

Guidelines are given below for gain settings 1.

The same guidelines apply to gain settings 2 (Pn104, Pn105, Pn106, and Pn412).

For I-P control, the relationships between the speed loop integral time constant, speed loop gain, and position loop gain are different from the relationships for PI control. The relationship between other servo gains is the same as for PI control.

- Speed Loop Gain (Pn100 [Hz]) and Speed Loop Integral Time Constant (Pn101 [ms])  
Stable gain:  $Pn100 [Hz] \geq 320 / Pn101 [ms]$
- Position Loop Gain (Pn102 [/s]) and Speed Loop Integral Time Constant (Pn101 [ms])  
Stable gain:  $Pn102 [/s] \leq 320 / Pn101 [ms]$

#### Information Selecting the Speed Loop Control Method (PI Control or I-P Control)

Usually, I-P control is effective for high-speed positioning and high-speed, high-precision processing applications. With I-P control, you can use a lower position loop gain than for PI control to reduce the positioning time and reduce arc radius reduction. However, if you can use mode switching to change to proportional control to achieve the desired application, then using PI control would be the normal choice.

### ◆ Decimal Points in Parameter Settings

For the SGD7W SERVOPACKs, decimal places are given for the settings of parameters on the Digital Operator, Panel Operator, and in the manual. For example with Pn100 (Speed Loop Gain), Pn100 = 40.0 is used to indicate a setting of 40.0 Hz. In the following adjusted value guidelines, the decimal places are also given.

- Example**
- Speed Loop Gain (Pn100 [Hz]) and Speed Loop Integral Time Constant (Pn101 [ms])  
Stable gain:  $Pn101 [ms] \geq 4,000 / (2\pi \times Pn100 [Hz])$ , therefore  
If Pn100 = 40.0 [Hz], then Pn101 =  $4,000 / (2\pi \times 40.0) \approx 15.92$  [ms].

## Model Following Control

You can use model following control to improve response characteristic and shorten positioning time. You can use model following control only with position control.

Normally, the parameters that are used for model following control are automatically set along with the servo gains by executing autotuning or custom tuning. However, you must adjust them manually in the following cases.

- When the tuning results for autotuning or custom tuning are not acceptable
- When you want to increase the response characteristic higher than that achieved by the tuning results for autotuning or custom tuning
- When you want to determine the servo gains and model following control parameters yourself

The block diagram for model following control is provided below.

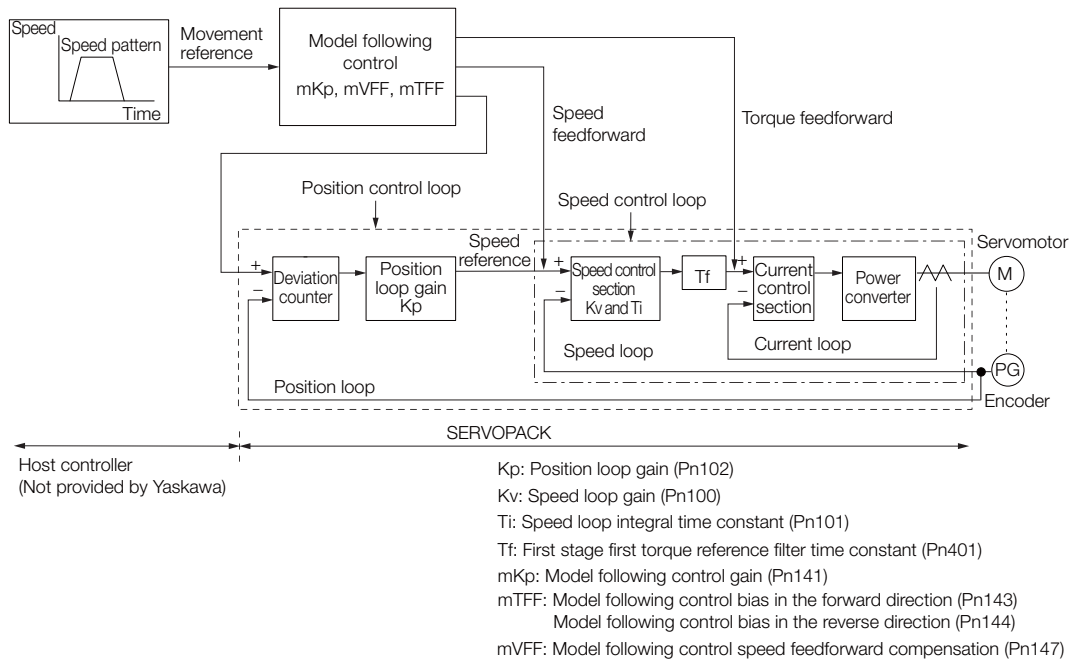

### ◆ Manual Tuning Procedure

Use the following tuning procedure for using model following control.

Step	Description
1	Friction compensation must also be used. Set the friction compensation parameters. Refer to the following section for the setting procedure. 8.12.2 Friction Compensation on page 8-72
2	Adjust the servo gains. Refer to the following section for an example procedure. Tuning Procedure Example (for Position Control or Speed Control) on page 8-83 Note: 1. Set the moment of inertia ratio (Pn103) as accurately as possible. 2. Refer to the guidelines for manually tuning the servo gains and set a stable gain for the position loop gain (Pn102). Guidelines for Manually Tuning Servo Gains on page 8-88
3	Increase the model following control gain (Pn141) as much as possible within the range in which overshooting and vibration do not occur.
4	If overshooting occurs or if the response is different for forward and reverse operation, fine-tune model following control with the following settings: model following control bias in the forward direction (Pn143), model following control bias in the reverse direction (Pn144), and model following control speed feedforward compensation (Pn147).

### ◆ Related Parameters

Next we will describe the following parameters that are used for model following control.

- Pn140 (Model Following Control-Related Selections)
- Pn141 (Model Following Control Gain)
- Pn143 (Model Following Control Bias in the Forward Direction)
- Pn144 (Model Following Control Bias in the Reverse Direction)
- Pn147 (Model Following Control Speed Feedforward Compensation)

### ■ Model Following Control-Related Selections

Set Pn140 = n.□□□X to specify whether to use model following control.

If you use model following control with vibration suppression, set Pn140 to n.□□1□ or Pn140 = n.□□2□. When you also perform vibration suppression, adjust vibration suppression with custom tuning in advance.

Note: If you use vibration suppression (Pn140 = n.□□1□ or Pn140 = n.□□2□), always set Pn140 to n.□□□1 (Use model following control).

Parameter	Function	When Enabled	Classification
Pn140	n.□□□0 (default setting)	Immediately	Tuning
	n.□□□1		
	n.□□0□ (default setting)		
	n.□□1□		
	n.□□2□		

### ■ Model Following Control Gain

The model following control gain determines the response characteristic of the servo system. If you increase the setting of the model following control gain, the response characteristic will improve and the positioning time will be shortened. The response characteristic of the servo system is determined by this parameter, and not by Pn102 (Position Loop Gain).

Pn141	Model Following Control Gain				Position
	Setting Range	Setting Unit	Default Setting	When Enabled	Classification
	10 to 20,000	0.1/s	500	Immediately	Tuning

#### Information

For machines for which a high model following control gain cannot be set, the size of the position deviation in model following control will be determined by the setting of the model following control gain. For a machine with low rigidity, in which a high model following control gain cannot be set, position deviation overflow alarms may occur during high-speed operation. If that is the case, you can increase the setting of the following parameter to increase the level for alarm detection.

Use the following conditional expression for reference in determining the setting.

$$Pn\ 520 \geq \frac{\text{Maximum feed speed [reference units/s]}}{Pn\ 141/10 [1/s]} \times 2.0$$

Pn520	Position Deviation Overflow Alarm Level					Position
	Setting Range	Setting Unit	Default Setting	When Enabled	Classification	
	1 to 1,073,741,823	1 reference unit	5,242,880	Immediately	Setup	

### ■ Model Following Control Bias in the Forward Direction and Model Following Control Bias in the Reverse Direction

If the response is different for forward and reverse operation, use the following parameters for fine-tuning.

If you decrease the settings, the response characteristic will be lowered but overshooting will be less likely to occur.

Pn143	Model Following Control Bias in the Forward Direction					Position
	Setting Range	Setting Unit	Default Setting	When Enabled	Classification	
	0 to 10,000	0.1%	1,000	Immediately	Tuning	

Pn144	Model Following Control Bias in the Reverse Direction					Position
	Setting Range	Setting Unit	Default Setting	When Enabled	Classification	
	0 to 10,000	0.1%	1,000	Immediately	Tuning	

■ Model Following Control Speed Feedforward Compensation

If overshooting occurs even after you adjust the model following control gain, model following control bias in the forward direction, and model following control bias in the reverse direction, you may be able to improve performance by setting the following parameter.

If you decrease the settings, the response characteristic will be lowered but overshooting will be less likely to occur.

Pn147	Model Following Control Speed Feedforward Compensation				Position
	Setting Range	Setting Unit	Default Setting	When Enabled	Classification
	0 to 10,000	0.1%	1,000	Immediately	Tuning

■ Model Following Control Type Selection

When you enable model following control, you can select the model following control type. Normally, set Pn14F to n.□□□1 (Use model following control type 2) (default setting). If compatibility with previous models is required, set Pn14F to n.□□□0 (Use model following control type 1).

Parameter	Meaning	When Enabled	Classification
Pn14F	n.□□□0	After restart	Tuning
	n.□□□1 (default setting)		

## 8.13.2 Compatible Adjustment Functions

The compatible adjustment functions are used together with manual tuning. You can use these functions to improve adjustment results. These functions allow you to use the same functions as for Σ-III-Series SERVOPACKs to adjust Σ-7-Series SERVOPACKs.

### Feedforward

The feedforward function applies feedforward compensation to position control to shorten the positioning time.

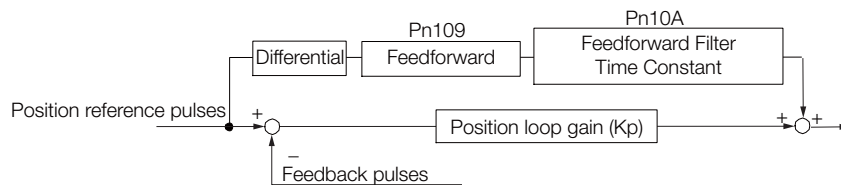

Pn109	Feedforward				Position
	Setting Range	Setting Unit	Default Setting	When Enabled	Classification
	0 to 100	1%	0	Immediately	Tuning
Pn10A	Feedforward Filter Time Constant				Position
	Setting Range	Setting Unit	Default Setting	When Enabled	Classification
	0 to 6,400	0.01 ms	0	Immediately	Tuning

Note: If you set the feedforward value too high, the machine may vibrate. As a guideline, use a setting of 80% or less.

## Mode Switching (Changing between Proportional and PI Control)

You can use mode switching to automatically change between proportional control and PI control.

Overshooting caused by acceleration and deceleration can be suppressed and the settling time can be reduced by setting the switching condition and switching levels.

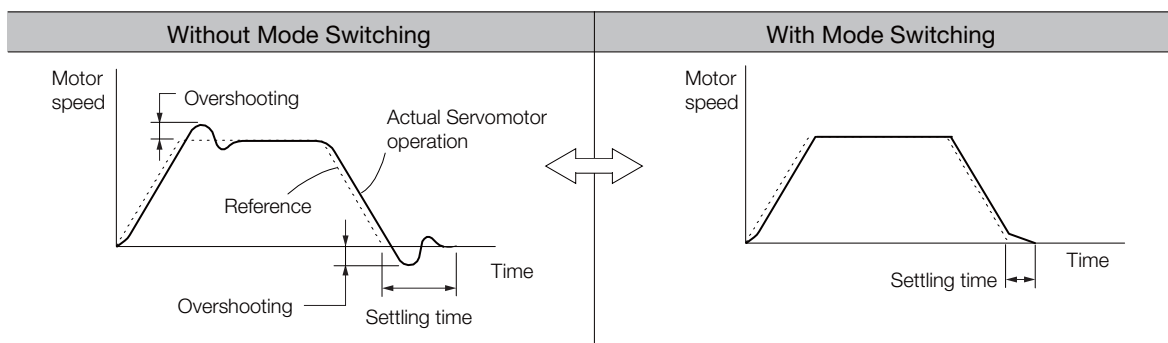

### ◆ Related Parameters

Select the switching condition for mode switching with Pn10B = n.□□□X.

Parameter	Mode Switching Selection	Parameter That Sets the Level		When Enabled	Classification
		Rotary Servomotor	Linear Servomotor		
Pn10B	n.□□□0 (default setting)	Use the internal torque reference as the condition.		Immediately	Setup
	n.□□□1	Pn10D	Pn181		
	n.□□□2	Pn10E	Pn182		
	n.□□□3	Use the position deviation as the condition.			
	n.□□□4	Do not use mode switching.			

### ■ Parameters That Set the Switching Levels

#### • Rotary Servomotors

Pn10C	Mode Switching Level for Torque Reference <span style="float:right">[Speed] [Position]</span>				
	Setting Range	Setting Unit	Default Setting	When Enabled	Classification
	0 to 800	1%	200	Immediately	Tuning
Pn10D	Mode Switching Level for Speed Reference <span style="float:right">[Speed] [Position]</span>				
	Setting Range	Setting Unit	Default Setting	When Enabled	Classification
	0 to 10,000	1 min <sup>-1</sup>	0	Immediately	Tuning
Pn10E	Mode Switching Level for Acceleration <span style="float:right">[Speed] [Position]</span>				
	Setting Range	Setting Unit	Default Setting	When Enabled	Classification
	0 to 30,000	1 min <sup>-1</sup> /s	0	Immediately	Tuning
Pn10F	Mode Switching Level for Position Deviation <span style="float:right">[Position]</span>				
	Setting Range	Setting Unit	Default Setting	When Enabled	Classification
	0 to 10,000	1 reference unit	0	Immediately	Tuning

• Linear Servomotors

Pn10C	Mode Switching Level for Force Reference			Speed	Position
	Setting Range	Setting Unit	Default Setting	When Enabled	Classification
	0 to 800	1%	200	Immediately	Tuning
Pn181	Mode Switching Level for Speed Reference			Speed	Position
	Setting Range	Setting Unit	Default Setting	When Enabled	Classification
	0 to 10,000	1 mm/s	0	Immediately	Tuning
Pn182	Mode Switching Level for Acceleration			Speed	Position
	Setting Range	Setting Unit	Default Setting	When Enabled	Classification
	0 to 30,000	1 mm/s <sup>2</sup>	0	Immediately	Tuning
Pn10F	Mode Switching Level for Position Deviation				Position
	Setting Range	Setting Unit	Default Setting	When Enabled	Classification
	0 to 10,000	1 reference unit	0	Immediately	Tuning

■ Using the Internal Torque Reference as the Mode Switching Condition (Default Setting)

When the Internal torque reference equals or exceeds the torque set for the mode switching level for torque reference (Pn10C), the speed loop is changed to P control.

The default setting for the torque reference level is 200%.

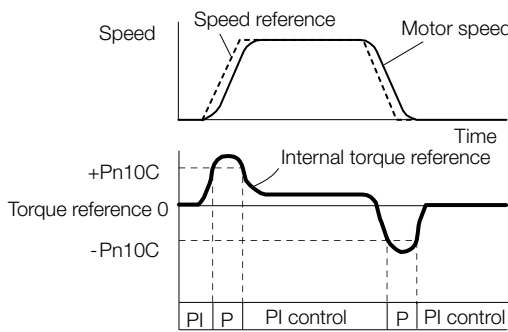

■ Using the Speed Reference as the Mode Switching Condition

• Rotary Servomotors

When the speed reference equals or exceeds the speed set for the mode switching level for a speed reference (Pn10D), the speed loop is changed to P control.

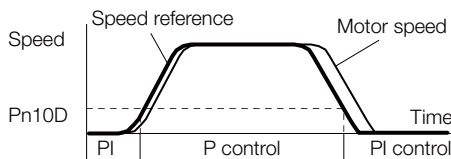

• Linear Servomotors

When the speed reference equals or exceeds the speed set for the mode switching level for a speed reference (Pn181), the speed loop is changed to P control.

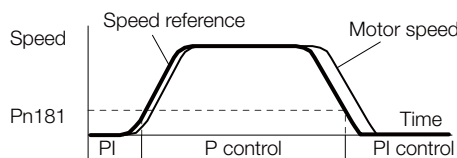

### ■ Using the Acceleration as the Mode Switching Condition

#### • Rotary Servomotors

When the speed reference equals or exceeds the acceleration rate set for the mode switching level for acceleration (Pn10E), the speed loop is changed to P control.

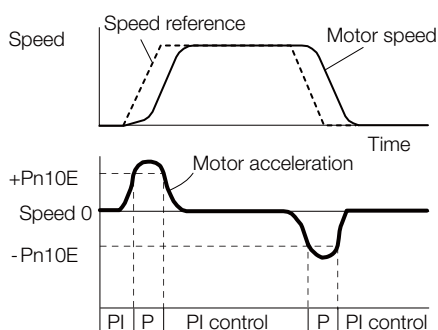

#### • Linear Servomotors

When the speed reference equals or exceeds the acceleration rate set for the mode switching level for acceleration (Pn182), the speed loop is changed to P control.

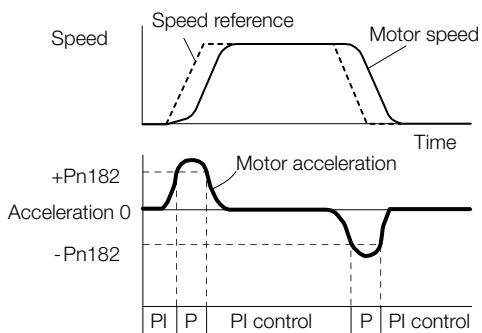

### ■ Using the Position Deviation as the Mode Switching Condition

When the position deviation equals or exceeds the value set for the mode switching level for position deviation (Pn10F), the speed loop is changed to P control.

This setting is enabled only for position control.

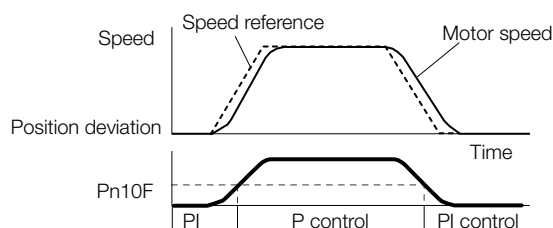

## Position Integral

The position integral is the integral function of the position loop. It is used for the electronic cams and electronic shafts when using the SERVOPACK with a Yaskawa MP3000-Series Machine Controller.

Pn11F	Position Integral Time Constant				
	Setting Range	Setting Unit	Default Setting	When Enabled	Classification
	0 to 50,000	0.1 ms	0	Immediately	Tuning



# 8.14 Diagnostic Tools

## 8.14.1 Mechanical Analysis

### Overview

You can connect the SERVOPACK to a computer to measure the frequency characteristics of the machine. This allows you to measure the frequency characteristics of the machine without using a measuring instrument.

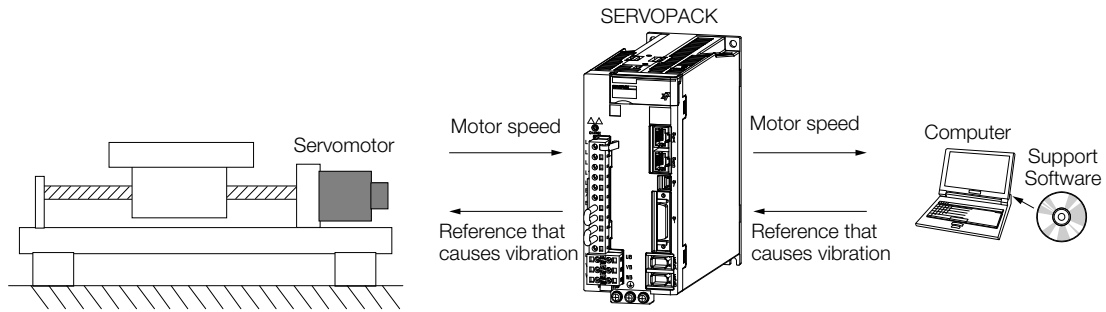

The Servomotor is used to cause machine vibration and then the speed frequency characteristics for the motor torque are measured. The measured frequency characteristics can be used to determine the machine resonance.

You determine the machine resonance for use in servo tuning and as reference for considering changes to the machine. The performance of the servo cannot be completely utilized depending on the rigidity of the machine. You may need to consider making changes to the machine. The information can also be used as reference for servo tuning to help you adjust parameters, such as the servo rigidity and torque filter time constant.

You can also use the information to set parameters, such as the notch filters.

### WARNING

- Mechanical analysis requires operating the Servomotor and therefore presents hazards. Before you execute mechanical analysis, check the information provided in the SigmaWin+ operating manual.

## Frequency Characteristics

The Servomotor is used to cause the machine to vibrate and the frequency characteristics from the torque to the motor speed are measured to determine the machine characteristics. For a normal machine, the resonance frequencies are clear when the frequency characteristics are plotted on graphs with the gain and phase (Bode plots). The Bode plots show the size (gain) of the response of the machine to which the torque is applied, and the phase delay (phase) in the response for each frequency. Also, the machine resonance frequency can be determined from the maximum frequency of the valleys (anti-resonance) and peaks (resonance) of the gain and the phase delay.

For a Servomotor without a load or for a rigid mechanism, the gain and phase change gradually in the Bode plots.

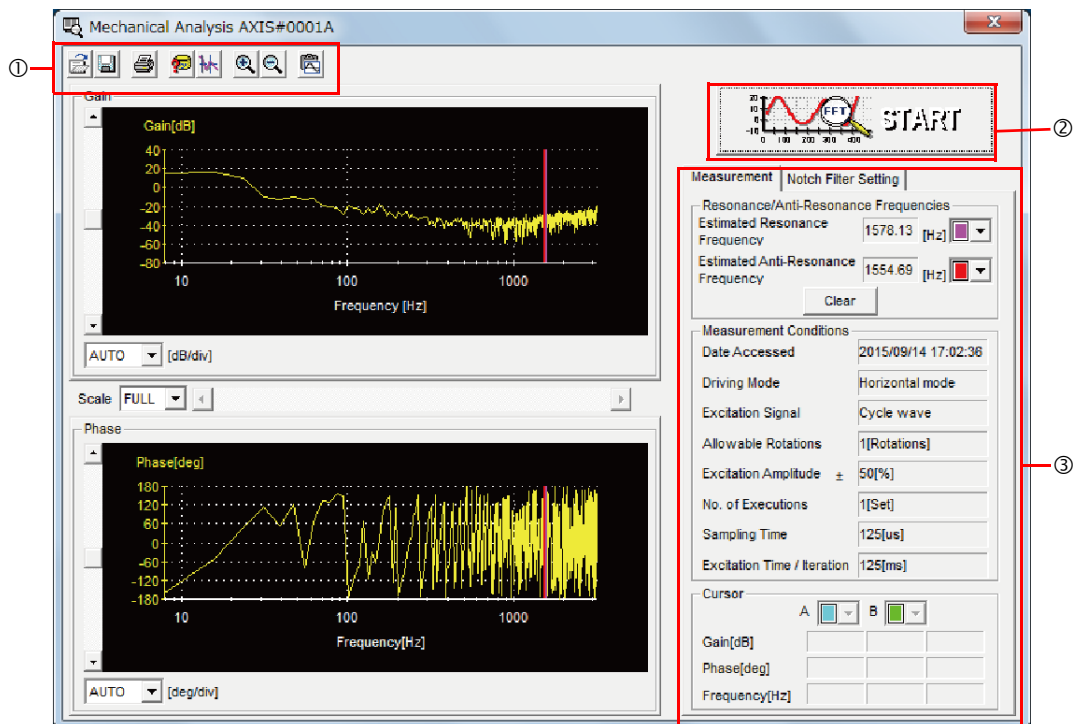

① Toolbar

② **START** Button

Click the **START** Button to start analysis.

③ **Measurement** and **Notch Filter Setting** Tab Pages

**Measurement** Tab Page: Displays detailed information on the results of analysis.

**Notch Filter Setting** Tab Page: Displays the notch filter frequencies. You can set these values in the parameters.

## 8.14.2 Easy FFT

The machine is made to vibrate and a resonance frequency is detected from the generated vibration to set notch filters according to the detected resonance frequencies. This is used to eliminate high-frequency vibration and noise.

During execution of Easy FFT, a frequency waveform reference is sent from the SERVOPACK to the Servomotor to automatically cause the shaft to rotate multiple times within 1/4th of a rotation, thus causing the machine to vibrate.

Execute Easy FFT after the servo is turned OFF if operation of the SERVOPACK results in high-frequency noise and vibration.

### **WARNING**

- Never touch the Servomotor or machine during execution of Easy FFT. Doing so may result in injury.

## ⚠ CAUTION

- Use Easy FFT when the servo gain is low, such as in the initial stage of servo tuning. If you execute Easy FFT after you increase the gain, the machine may vibrate depending on the machine characteristics or gain balance.

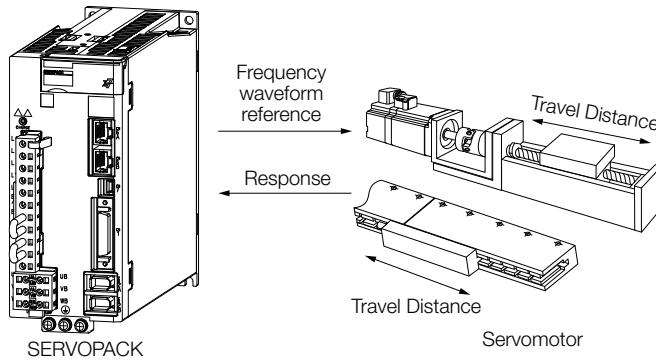

Easy FFT is built into the SERVOPACK for compatibility with previous products. Normally use autotuning without a host reference for tuning.

## Preparations

Always check the following before you execute Easy FFT.

- The parameters must not be write prohibited.
- The main circuit power supply must be ON.
- The test without a motor function must be disabled (Pn00C = n.□□□□).
- There must be no alarms.
- The servo must be OFF.
- There must be no overtravel.
- An external reference must not be input.

## Operating Procedure

Use the following procedure for Easy FFT.

1. Click the  Servo Drive Button in the workspace of the Main Window of the SigmaWin+.
2. Select **Easy FFT** in the Menu Dialog Box.  
The Easy FFT Dialog Box will be displayed.  
Click the **Cancel** Button to cancel Easy FFT. You will return to the main window.

## 3. Click the OK Button.

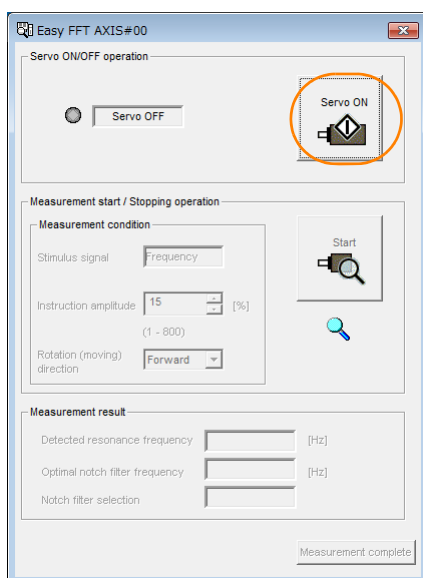
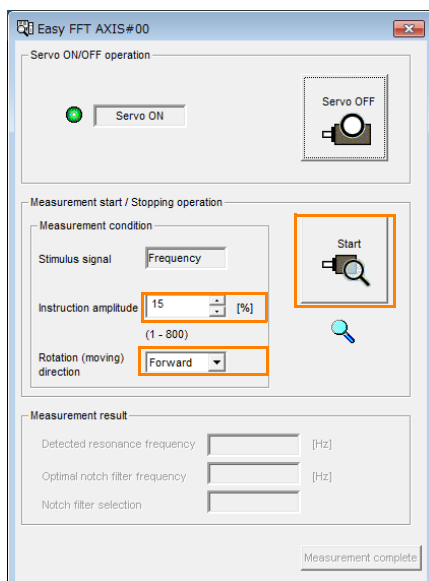

## 4. Click the Servo ON Button.

5. Select the instruction (reference) amplitude and the rotation direction in the **Measurement condition** Area, and then click the **Start** Button.  
The Servomotor shaft will rotate and measurements will start.

When measurements have been completed, the measurement results will be displayed.

6. Check the results in the **Measurement result Area** and then click the **Measurement complete Button**.

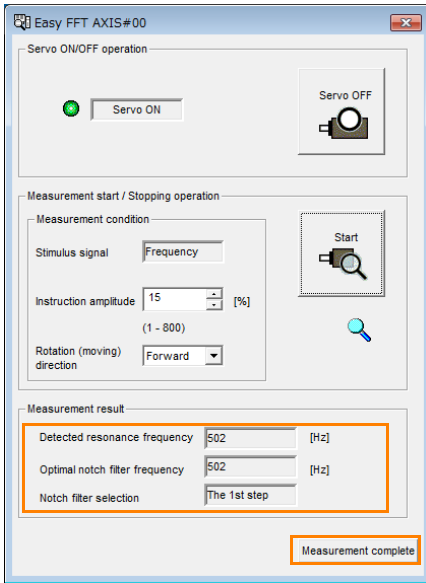

7. Click the **Result Writing Button** if you want to set the measurement results in the parameters.

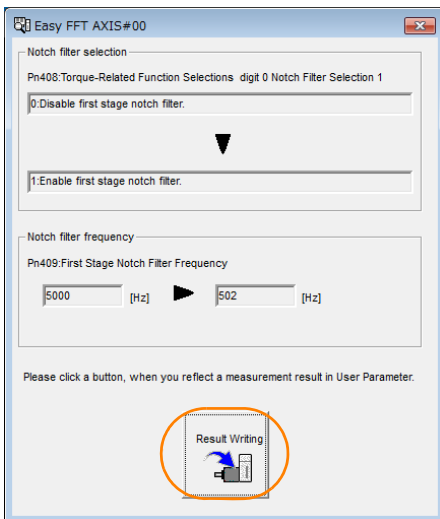

This concludes the procedure to set up Easy FFT.

## Related Parameters

The following parameters are automatically adjusted or used as reference when you execute Easy FFT.

Do not change the settings of these parameters during execution of Easy FFT.

Parameter	Name	Automatic Changes
Pn408	Torque-Related Function Selections	Yes
Pn409	First Stage Notch Filter Frequency	Yes
Pn40A	First Stage Notch Filter Q Value	No
Pn40C	Second Stage Notch Filter Frequency	Yes
Pn40D	Second Stage Notch Filter Q Value	No
Pn456	Sweep Torque Reference Amplitude	No

Yes: The parameter is automatically set.

No: The parameter is not automatically set, but the setting is read during execution.

# Monitoring

# 9

This chapter provides information on monitoring SERVOPACK product information and SERVOPACK status.

<b>9.1</b>	<b>Monitoring Product Information</b>	<b>9-2</b>
9.1.1	Items That You Can Monitor	9-2
9.1.2	Operating Procedures	9-2
<b>9.2</b>	<b>Monitoring SERVOPACK Status</b>	<b>9-3</b>
9.2.1	Servo Drive Status	9-3
9.2.2	Monitoring Status and Operations	9-3
9.2.3	I/O Signal Monitor	9-5
<b>9.3</b>	<b>Monitoring Machine Operation Status and Signal Waveforms</b>	<b>9-6</b>
9.3.1	Items That You Can Monitor	9-6
9.3.2	Using the SigmaWin+	9-7
9.3.3	Using the Analog Monitors	9-8
<b>9.4</b>	<b>Monitoring Product Life</b>	<b>9-14</b>
9.4.1	Items That You Can Monitor	9-14
9.4.2	Operating Procedure	9-15
9.4.3	Preventative Maintenance	9-16
<b>9.5</b>	<b>Alarm Tracing</b>	<b>9-17</b>
9.5.1	Data for Which Alarm Tracing Is Performed	9-17
9.5.2	Applicable Tools	9-17

# 9.1 Monitoring Product Information

## 9.1.1 Items That You Can Monitor

Monitor Items	
Information on SERVOPACKs	<ul style="list-style-type: none"> <li>• Model/Type</li> <li>• Serial Number</li> <li>• Manufacturing Date</li> <li>• Software version (SW Ver.)</li> <li>• Remarks</li> </ul>
Information on Servomotors	<ul style="list-style-type: none"> <li>• Model/Type</li> <li>• Serial Number</li> <li>• Manufacturing Date</li> <li>• Remarks</li> </ul>
Information on Encoders	<ul style="list-style-type: none"> <li>• Model/Type</li> <li>• Serial Number</li> <li>• Manufacturing Date</li> <li>• Software version (SW Ver.)</li> <li>• Remarks</li> </ul>

## 9.1.2 Operating Procedures

Use the following procedure to display the Servo Drive product information.

- Select **Read Product Information** in the Menu Dialog Box of the SigmaWin+. The Read Product Information Window will be displayed.

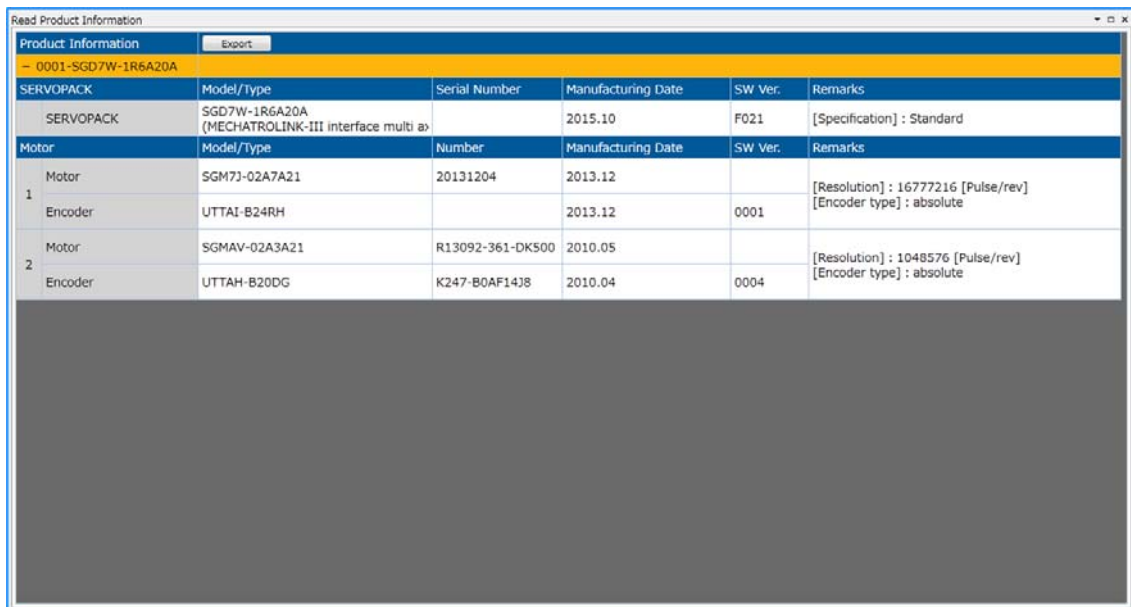

**Information**

With the Digital Operator, you can use Fn011, Fn012, and Fn01E to monitor this information. Refer to the following manual for the differences in the monitor items compared with the SigmaWin+.

📖 Σ-7-Series Digital Operator Operating Manual (Manual No.: SIEP S800001 33)

# 9.2 Monitoring SERVOPACK Status

## 9.2.1 Servo Drive Status

Use the following procedure to display the Servo Drive status.

- Start the SigmaWin+. The Servo Drive status will be automatically displayed when you go online with a SERVOPACK.

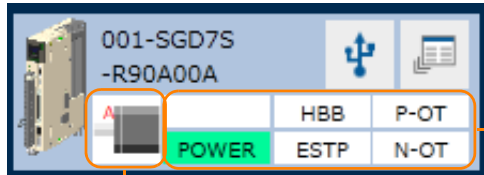

The Servo Drive status is displayed.

The Servomotor type is displayed.

## 9.2.2 Monitoring Status and Operations

### Items That You Can Monitor

The items that you can monitor on the Status Monitor Window and Motion Monitor Window are listed below.

- Status Monitor Window

Monitor Items		
Internal Status	<ul style="list-style-type: none"> <li>• Main Circuit</li> <li>• Encoder (PGRDY)</li> <li>• Motor Power (Request)</li> <li>• Motor Power ON</li> <li>• Dynamic Brake (DB)</li> <li>• Rotation (Movement) Direction</li> <li>• Mode Switch</li> <li>• Speed Reference (V-Ref)</li> <li>• Torque Reference (T-Ref)</li> <li>• Position Reference (PULS)</li> <li>• Position Reference Direction</li> <li>• Surge Current Limiting Resistor Short Relay</li> <li>• Regenerative Transistor Detection</li> <li>• AC Power ON</li> <li>• Overcurrent</li> <li>• Origin Not Passed</li> </ul>	<ul style="list-style-type: none"> <li>• /S-ON (Servo ON Input Signal)</li> <li>• /P-CON (Proportional Control Input Signal)</li> <li>• P-OT (Forward Drive Prohibit Input Signal)</li> <li>• N-OT (Reverse Drive Prohibit Input Signal)</li> <li>• /P-CL (Forward External Torque Limit Signal)</li> <li>• /N-CL (Reverse External Torque Limit Signal)</li> <li>• /ALM-RST (Alarm Reset Input Signal)</li> <li>• SEN (Absolute Data Request Input Signal)</li> <li>• /G-SEL (Gain Selection Input Signal)</li> <li>• /P-DET (Polarity Detection Input Signal)</li> <li>• /DEC (Origin Return Deceleration Switch Input Signal)</li> <li>• /EXT1 (External Latch Input 1 Signal)</li> <li>• /EXT2 (External Latch Input 2 Signal)</li> <li>• /EXT3 (External Latch Input 3 Signal)</li> <li>• FSTP (Forced Stop Input Signal)</li> </ul>
Output Signal Status	<ul style="list-style-type: none"> <li>• ALM (Servo Alarm Output Signal)</li> <li>• /COIN (Positioning Completion Output Signal)</li> <li>• /V-CMP (Speed Coincidence Detection Output Signal)</li> <li>• /TGON (Rotation Detection Output Signal)</li> <li>• /S-RDY (Servo Ready Output Signal)</li> <li>• /CLT (Torque Limit Detection Output Signal)</li> <li>• /VLT (Speed Limit Detection Output Signal)</li> <li>• /BK (Brake Output Signal)</li> <li>• /WARN (Warning Output Signal)</li> <li>• /NEAR (Near Output Signal)</li> <li>• /PM (Preventative Maintenance Output Signal)</li> </ul>	



• Motion Monitor Window

Monitor Items	
<ul style="list-style-type: none"> <li>• Current Alarm State</li> <li>• Motor Speed</li> <li>• Speed Reference</li> <li>• Internal Torque Reference</li> <li>• Angle of Rotation 1 (number of encoder pulses from origin within one encoder rotation)</li> <li>• Angle of Rotation 2 (angle from origin within one encoder rotation)</li> <li>• Input Reference Pulse Speed</li> <li>• Deviation Counter (Position Deviation)</li> <li>• Cumulative Load</li> <li>• Regenerative Load</li> </ul>	<ul style="list-style-type: none"> <li>• Power Consumption</li> <li>• Consumed Power</li> <li>• Cumulative Power Consumption</li> <li>• DB Resistor Consumption Power</li> <li>• Absolute Encoder Multiturn Data</li> <li>• Absolute Encoder Position within One Rotation</li> <li>• Absolute Encoder (Lower)</li> <li>• Absolute Encoder (Upper)</li> <li>• Reference Pulse Counter</li> <li>• Feedback Pulse Counter</li> <li>• Total Operating Time</li> </ul>

## Operating Procedure

Use the following procedure to display the Motion Monitor and Status Monitor for the SERVOPACK.

- Select **Monitor** in the Menu Dialog Box of the SigmaWin+. The Operation Pane and Status Pane will be displayed in the Monitor Window.

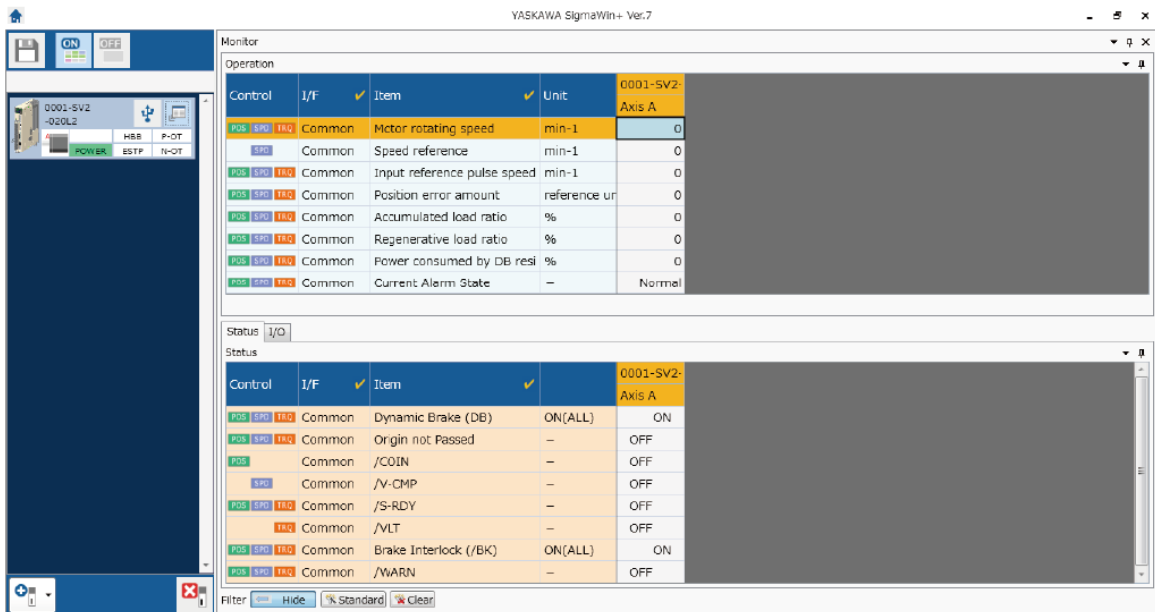

**Information** You can flexibly change the contents that are displayed in the Monitor Window. Refer to the following manual for details.

*Engineering Tool SigmaWin+ Operation Manual* (Manual No.: SIET S800001 34)

## 9.2.3 I/O Signal Monitor

Use the following procedure to check I/O signals.

1. Click the  Servo Drive Button in the workspace of the Main Window of the SigmaWin+.
2. Select **Wiring Check** in the Menu Dialog Box.  
The Wiring Check Dialog Box will be displayed.
3. Click the **Monitor Mode** Button.

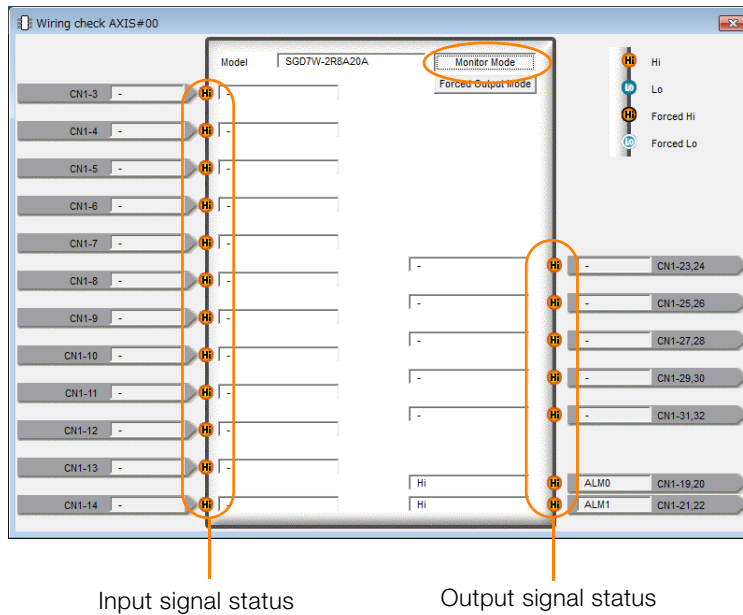

- Information** You can also use the above window to check wiring.
- **Checking Input Signal Wiring**  
Change the signal status at the host controller. If the input signal status on the window changes accordingly, then the wiring is correct.
  - **Checking Output Signal Wiring**  
Click the **Force Output Mode** Button. This will force the output signal status to change. If the signal status at the host controller changes accordingly, then the wiring is correct. You cannot use the **Force Output Mode** Button while the servo is ON.

# 9.3 Monitoring Machine Operation Status and Signal Waveforms

To monitor waveforms, use the SigmaWin+ trace function or a measuring instrument, such as a memory recorder.

## 9.3.1 Items That You Can Monitor

You can use the SigmaWin+ or a measuring instrument to monitor the shaded items in the following block diagram.

- Rotary Servomotors

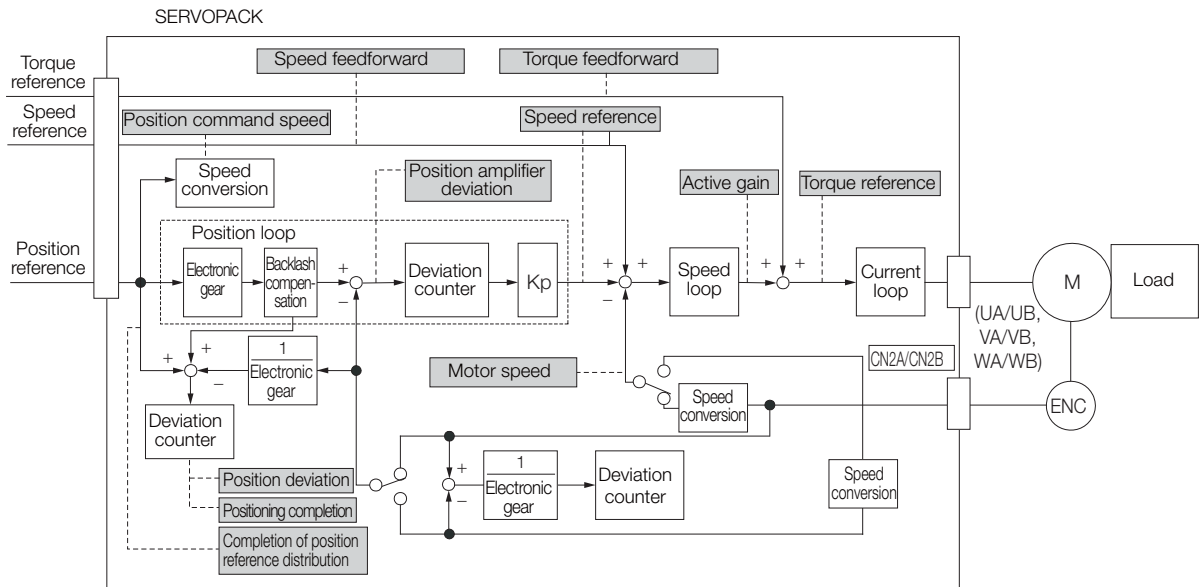

- Linear Servomotors

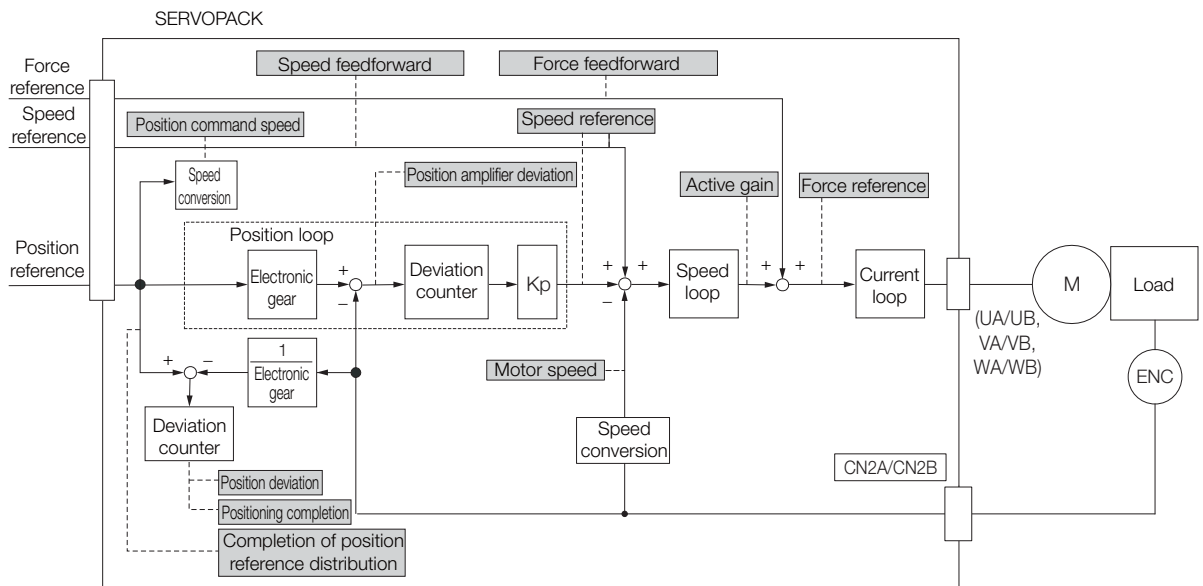

## 9.3.2 Using the SigmaWin+

This section describes how to trace data and I/O with the SigmaWin+.

Refer to the following manual for detailed operating procedures for the SigmaWin+.

AC Servo Drive Engineering Tool SigmaWin+ Operation Manual (Manual No.: SIET S800001 34)

### Operating Procedure

1. Click the Servo Drive Button in the workspace of the Main Window of the SigmaWin+.
2. Select **Trace** in the Menu Dialog Box.  
The Trace Dialog Box will be displayed.

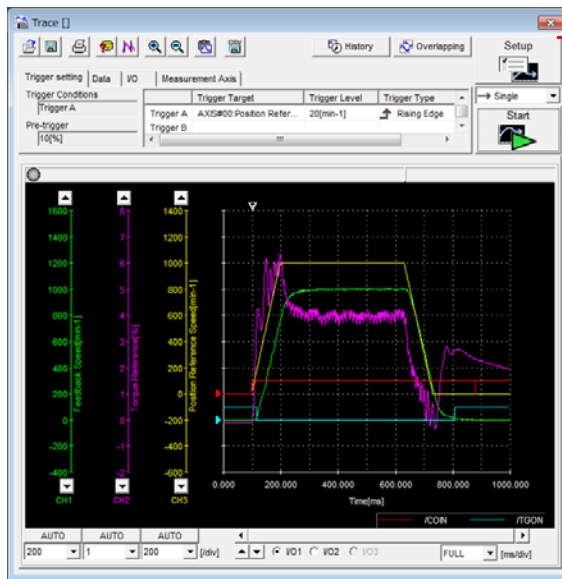

Click this button to display the Trace Setting Dialog Box shown below, and set the data to trace and the trace conditions.

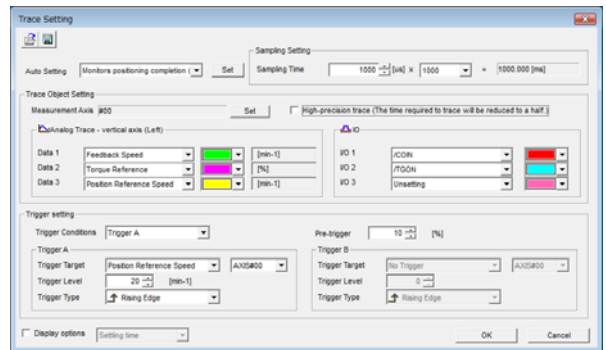

### Trace Objects

You can trace the following items.

- Data Tracing

Trace Objects	
<ul style="list-style-type: none"> <li>• Torque Reference</li> <li>• Feedback Speed</li> <li>• Reference Speed</li> <li>• Position Reference Speed</li> <li>• Position Error (Deviation)</li> <li>• Position Amplifier Error (Deviation)</li> </ul>	<ul style="list-style-type: none"> <li>• Speed Feedforward</li> <li>• Torque Feedforward</li> <li>• Effective (Active) Gain</li> <li>• Main Circuit DC Voltage</li> <li>• Control Mode</li> </ul>

• I/O Tracing

Trace Objects			
Input Signals	<ul style="list-style-type: none"> <li>• /S-ON (Servo ON Input Signal)</li> <li>• /P-CON (Proportional Control Input Signal)</li> <li>• P-OT (Forward Drive Prohibit Input Signal)</li> <li>• N-OT (Reverse Drive Prohibit Input Signal)</li> <li>• /ALM-RST (Alarm Reset Input Signal)</li> <li>• /P-CL (Forward External Torque/Force Limit Input Signal)</li> <li>• /N-CL (Reverse External Torque/Force Limit Input Signal)</li> <li>• /G-SEL (Gain Selection Input Signal)</li> <li>• /P-DET (Polarity Detection Input Signal)</li> <li>• /DEC (Origin Return Deceleration Switch Input Signal)</li> <li>• /EXT1 (External Latch Input 1 Signal)</li> <li>• /EXT2 (External Latch Input 2 Signal)</li> <li>• /EXT3 (External Latch Input 3 Signal)</li> <li>• FSTP (Forced Stop Input Signal)</li> <li>• SEN (Absolute Data Request Input Signal)</li> </ul>	Output Signals	<ul style="list-style-type: none"> <li>• ALM (Servo Alarm Output Signal)</li> <li>• /COIN (Positioning Completion Output Signal)</li> <li>• /V-CMP (Speed Coincidence Detection Output Signal)</li> <li>• /TGON (Rotation Detection Output Signal)</li> <li>• /S-RDY (Servo Ready Output Signal)</li> <li>• /CLT (Torque Limit Detection Output Signal)</li> <li>• /MLT (Speed Limit Detection Output Signal)</li> <li>• /BK (Brake Output Signal)</li> <li>• /WARN (Warning Output Signal)</li> <li>• /NEAR (Near Output Signal)</li> </ul>
		Internal Status	<ul style="list-style-type: none"> <li>• ACON (Main Circuit ON Signal)</li> <li>• PDETCMP (Polarity Detection Completed Signal)</li> <li>• DEN (Position Reference Distribution Completed Signal)</li> <li>• PSET (Positioning Completion Output Signal)</li> <li>• CMDRDY (Command Ready Signal)</li> </ul>

## 9.3.3 Using the Analog Monitors

Connect a measuring instrument, such as a memory recorder, to the analog monitor connector (CN5) on the SERVOPACK to monitor analog signal waveforms. The measuring instrument is not provided by Yaskawa.

Refer to the following section for details on the connection.

 4.7.3 Analog Monitor Connector (CN5) on page 4-42

### Setting the Monitor Object

Use Pn006 = n.X□□□ and Pn007 = n.X□□□ (Output Axis Selection) to set the axis to monitor.

Parameter	Description	When Enabled	Classification
Pn006 Pn007 All Axes	n.0□□□ (default setting)	Immediately	Setup
	n.1□□□		

Use Pn006 = n.□□XX and Pn007 = n.□□XX (Analog Monitor 1 and 2 Signal Selections) to set the items to monitor.

Line Color	Signal	Parameter Setting
White	Analog monitor 1	Pn006 = n.□□XX
Red	Analog monitor 2	Pn007 = n.□□XX
Black (2 lines)	GND	-

Parameter		Description		
		Monitor Signal	Output Unit	Remarks
Pn006 or Pn007  All Axes	n.□□00 (default setting of Pn007)	Motor Speed	<ul style="list-style-type: none"> <li>Rotary Servomotor: 1 V/1,000 min<sup>-1</sup></li> <li>Linear Servomotor: 1 V/1,000 mm/s</li> </ul>	–
	n.□□01	Speed Reference	<ul style="list-style-type: none"> <li>Rotary Servomotor: 1 V/1,000 min<sup>-1</sup></li> <li>Linear Servomotor: 1 V/1,000 mm/s</li> </ul>	–
	n.□□02 (default setting of Pn006)	Torque Reference	1 V/100% rated torque	–
	n.□□03	Position Deviation	0.05 V/Reference unit	0 V for speed or torque control
	n.□□04	Position Amplifier Deviation	0.05 V/encoder pulse unit	Position deviation after electronic gear conversion
	n.□□05	Position Command Speed	<ul style="list-style-type: none"> <li>Rotary Servomotor: 1 V/1,000 min<sup>-1</sup></li> <li>Linear Servomotor: 1 V/1,000 mm/s</li> </ul>	–
	n.□□06	Reserved parameter (Do not change.)	–	–
	n.□□07	Reserved parameter (Do not change.)	–	–
	n.□□08	Positioning Completion	Positioning completed: 5 V Positioning not completed: 0 V	Completion is indicated by the output voltage.
	n.□□09	Speed Feedforward	<ul style="list-style-type: none"> <li>Rotary Servomotor: 1 V/1,000 min<sup>-1</sup></li> <li>Linear Servomotor: 1 V/1,000 mm/s</li> </ul>	–
	n.□□0A	Torque Feedforward	1 V/100% rated torque	–
	n.□□0B	Active Gain*	1st gain: 1 V 2nd gain: 2 V	The gain that is active is indicated by the output voltage.
	n.□□0C	Completion of Position Reference Distribution	Distribution completed: 5 V Distribution not completed: 0 V	Completion is indicated by the output voltage.
	n.□□0D	Reserved parameter (Do not change.)	–	–
n.□□10	Main Circuit DC Voltage	1 V/100 V (main circuit DC voltage)	–	

\* Refer to the following section for details.

 8.12.1 Gain Switching on page 8-68

## Changing the Monitor Factor and Offset

You can change the monitor factors and offsets for the output voltages for analog monitor 1 and analog monitor 2. The relationships to the output voltages are as follows:

$$\text{Analog monitor 1 output voltage} = (-1) \times \left\{ \begin{array}{l} \text{Analog Monitor 1 Signal} \\ \text{Selection (Pn006 = n.}\square\square\text{XX)} \times \text{Magnification (Pn552)} + \text{Offset Voltage (Pn550)} \end{array} \right\}$$

$$\text{Analog monitor 2 output voltage} = (-1) \times \left\{ \begin{array}{l} \text{Analog Monitor 2 Signal} \\ \text{Selection (Pn007 = n.}\square\square\text{XX)} \times \text{Magnification (Pn553)} + \text{Offset Voltage (Pn551)} \end{array} \right\}$$

The following parameters are set.

Pn550 All Axes	Analog Monitor 1 Offset Voltage <span style="float:right">Speed Position Torque</span>				
	Setting Range	Setting Unit	Default Setting	When Enabled	Classification
	-10,000 to 10,000	0.1 V	0	Immediately	Setup
Pn551 All Axes	Analog Monitor 2 Offset Voltage <span style="float:right">Speed Position Torque</span>				
	Setting Range	Setting Unit	Default Setting	When Enabled	Classification
	-10,000 to 10,000	0.1 V	0	Immediately	Setup
Pn552 All Axes	Analog Monitor 1 Magnification <span style="float:right">Speed Position Torque</span>				
	Setting Range	Setting Unit	Default Setting	When Enabled	Classification
	-10,000 to 10,000	x0.01	100	Immediately	Setup
Pn553 All Axes	Analog Monitor 2 Magnification <span style="float:right">Speed Position Torque</span>				
	Setting Range	Setting Unit	Default Setting	When Enabled	Classification
	-10,000 to 10,000	x0.01	100	Immediately	Setup

**Example**

- Example for Setting the Item to Monitor to the Motor Speed (Pn006 = n.□□00)

When Pn552 = 100 (Setting Unit: x0.01)

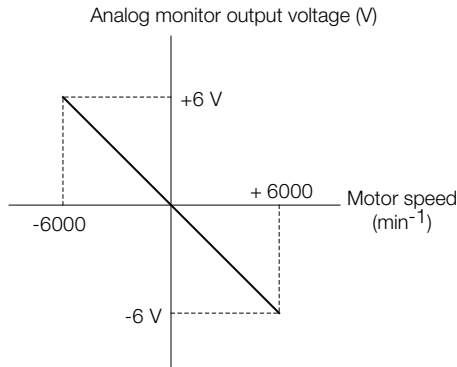

When Pn552 = 1,000 (Setting Unit: x0.01)

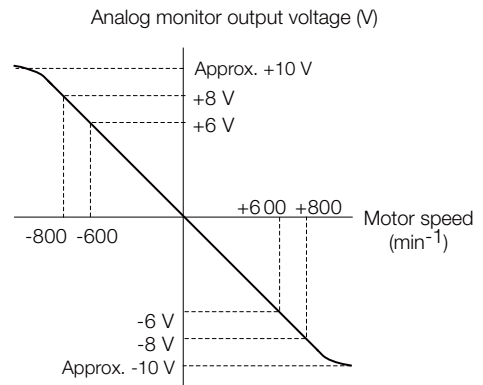

Note: The effective linearity range is ±8 V.  
The resolution is 16 bits.

## Adjusting the Analog Monitor Output

You can manually adjust the offset and gain for the analog monitor outputs for the torque reference monitor and motor speed monitor.

The offset is adjusted to compensate for offset in the zero point caused by output voltage drift or noise in the monitoring system.

The gain is adjusted to match the sensitivity of the measuring system.

The offset and gain are adjusted at the factory. You normally do not need to adjust them.



The analog monitor output adjustment applies to both axes A and B.  
If you change the adjustment, the new adjustment will be applied to both axes.

### ◆ Adjustment Example

An example of adjusting the output of the motor speed monitor is provided below.

Offset Adjustment		Gain Adjustment	
Item	Specification	Item	Specification
Offset Adjustment Range	-2.4 V to 2.4 V	Gain Adjustment Range	100 ±50%
Adjustment Unit	18.9 mV/LSB	Adjustment Unit	0.4%/LSB

The gain adjustment range is made using a 100% output value (gain adjustment of 0) as the reference value with an adjustment range of 50% to 150%. A setting example is given below.

- Setting the Adjustment Value to -125  
 $100 + (-125 \times 0.4) = 50$  [%]  
 Therefore, the monitor output voltage goes to 50% of the original value.
- Setting the Adjustment Value to 125  
 $100 + (125 \times 0.4) = 150$  [%]  
 Therefore, the monitor output voltage goes to 150% of the original value.

#### Information

- The adjustment values do not use parameters, so they will not change even if the parameter settings are initialized.
- Adjust the offset with the measuring instrument connected so that the analog monitor output value goes to zero. The following setting example achieves a zero output.
  - While power is not supplied to the Servomotor, set the monitor signal to the torque reference.
  - In speed control, set the monitor signal to the position deviation.



### ◆ Preparations



Always check the following before you adjust the analog monitor output.

- The parameters must not be write prohibited.



### ◆ Applicable Tools

You can use the following tools to adjust analog monitor outputs. The function that is used is given for each tool.

- Offset Adjustment

Tool	Function	Operating Procedure Reference
Digital Operator	Fn00C	 Σ-7-Series Digital Operator Operating Manual (Manual No.: SIEP S800001 33)
SigmaWin+	<b>Setup - Adjust the Analog Monitor Output</b>	 ◆ Operating Procedure on page 9-13

- Gain Adjustment

Tool	Function	Operating Procedure Reference
Digital Operator	Fn00D	 Σ-7-Series Digital Operator Operating Manual (Manual No.: SIEP S800001 33)
SigmaWin+	<b>Setup - Adjust the Analog Monitor Output</b>	 ◆ Operating Procedure on page 9-13

## ◆ Operating Procedure

Use the following procedure to adjust the analog monitor output.

1. Click the  Servo Drive Button in the workspace of the Main Window of the SigmaWin+.
2. Select **Adjust the Analog Monitor Output** in the Menu Dialog Box. The Adjust the Analog Monitor Output Dialog Box will be displayed.
3. Click the **Zero Adjustment** or **Gain Adjustment** Tab.

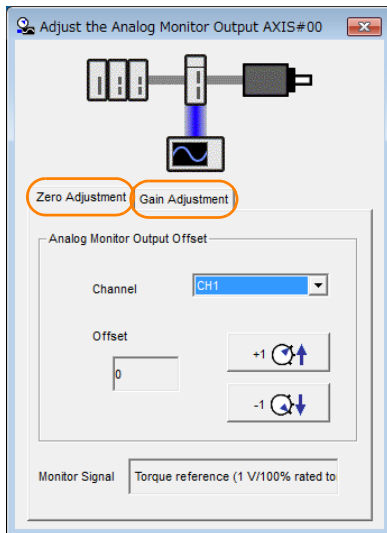



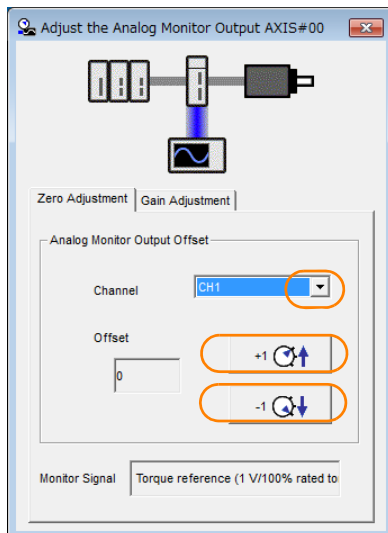

4. While watching the analog monitor, use the **+1** and **-1** Buttons to adjust the offset. There are two channels: CH1 and CH2. If necessary, click the down arrow on the **Channel** Box and select the channel.



This concludes adjusting the analog monitor output.

## 9.4 Monitoring Product Life

### 9.4.1 Items That You Can Monitor

Monitor Item	Description
SERVOPACK Installation Environment	The operating status of the SERVOPACK in terms of the installation environment is displayed. Implement one or more of the following actions if the monitor value exceeds 100%. <ul style="list-style-type: none"> <li>• Lower the surrounding temperature.</li> <li>• Decrease the load.</li> </ul>
Servomotor Installation Environment	The operating status of the SERVOPACK in terms of the installation environment is displayed. Implement one or more of the following actions if the monitor value exceeds 100%. <ul style="list-style-type: none"> <li>• Lower the surrounding temperature.</li> <li>• Decrease the load.</li> </ul>
Built-in Fan Service Life Prediction	The unused status of the SERVOPACK is treated as the 100% value. The value decreases each time the main circuit power supply is turned ON and each time the servo is turned OFF. Use a monitor value of 0% as a guideline for the replacement period. Refer to the following section for part replacement guidelines.  <i>10.1.2 Guidelines for Part Replacement on page 10-2</i>
Capacitor Service Life Prediction	The unused status of the SERVOPACK is treated as the 100% value. The value decreases each time the main circuit power supply is turned ON and each time the servo is turned OFF. Use a monitor value of 0% as a guideline for the replacement period. Refer to the following section for part replacement guidelines.  <i>10.1.2 Guidelines for Part Replacement on page 10-2</i>
Surge Prevention Circuit Service Life Prediction	The unused status of the SERVOPACK is treated as the 100% value. The value decreases each time the main circuit power supply is turned ON and each time the servo is turned OFF. Use a monitor value of 0% as a guideline for the replacement period. Refer to the following section for part replacement guidelines.  <i>10.1.2 Guidelines for Part Replacement on page 10-2</i>
Dynamic Brake Circuit Service Life Prediction	The unused status of the SERVOPACK is treated as the 100% value. The value decreases each time the main circuit power supply is turned ON and each time the servo is turned OFF. Use a monitor value of 0% as a guideline for the replacement period. Refer to the following section for part replacement guidelines.  <i>10.1.2 Guidelines for Part Replacement on page 10-2</i>

## 9.4.2 Operating Procedure

Use the following procedure to display the installation environment and service life prediction monitor dialog boxes.

1. Click the  Servo Drive Button in the workspace of the Main Window of the SigmaWin+.
2. Select **Life Monitor** in the Menu Dialog Box.  
The Life Monitor Dialog Box will be displayed.

**Information** With the Digital Operator, you can use Un025 to Un02A to monitor this information.

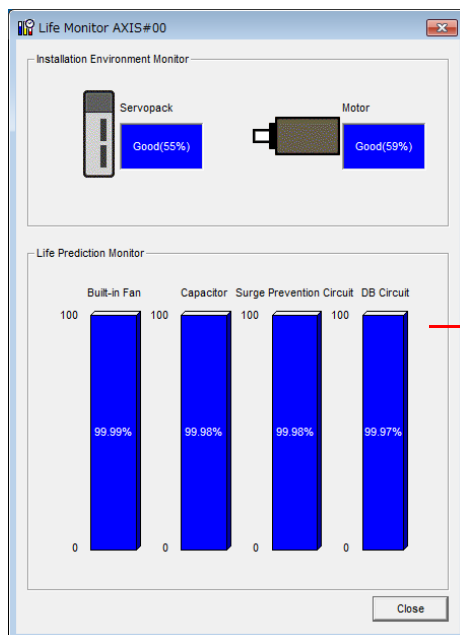

A value of 100% indicates that the SERVOPACK has not yet been used. The percentage decreases as the SERVOPACK is used and reaches 0% when it is time to replace the SERVOPACK.

## 9.4.3 Preventative Maintenance

You can use the following functions for preventative maintenance.

- Preventative maintenance warnings
- /PM (Preventative Maintenance Output) signal

The SERVOPACK can notify the host controller when it is time to replace any of the main parts.

### Preventative Maintenance Warning

An A.9b0 warning (Preventative Maintenance Warning) is detected when any of the following service life prediction values drops to 10% or less: SERVOPACK built-in fan life, capacitor life, inrush current limiting circuit life, and dynamic brake circuit life. You can change the setting of Pn00F = n.□□□X to enable or disable these warnings.

Parameter		Description	When Enabled	Classification
Pn00F	n.□□□0 (default setting)	Do not detect preventative maintenance warnings.	After restart	Setup
	n.□□□1	Detect preventative maintenance warnings.		

### /PM (Preventative Maintenance Output) Signal

The /PM (Preventative Maintenance Output) signal is output when any of the following service life prediction values reaches 10% or less: SERVOPACK built-in fan life, capacitor life, inrush current limiting circuit life, and dynamic brake circuit life. The /PM (Preventative Maintenance Output) signal must be allocated.

Even if detection of preventive maintenance warnings is disabled (Pn00F = n.□□□0), the /PM signal will still be output as long as it is allocated.

Classification	Signal	Connector Pin No.	Signal Status	Description
Output	/PM	Must be allocated.	ON (closed)	One of the following service life prediction values reached 10% or less: SERVOPACK built-in fan life, capacitor life, inrush current limiting circuit life, and dynamic brake circuit life.
			OFF (open)	All of the following service life prediction values are greater than 10%: SERVOPACK built-in fan life, capacitor life, inrush current limiting circuit life, and dynamic brake circuit life.

Note: You must allocate the /PM signal to use it. The parameters that you use depend on the allocation method.

Allocation Method	Parameters to Use
Σ-7S-Compatible I/O Signal Allocations	<ul style="list-style-type: none"> <li>• Pn50A = n.□□□1 (Σ-7S-Compatible I/O Signal Allocations)</li> <li>• Pn514 = n.□X□□ (/PM (Preventative Maintenance Output) Signal Allocation)</li> </ul>
Multi-axis I/O signal allocations	<ul style="list-style-type: none"> <li>• Pn50A = n.□□□2 (Multi-Axis I/O Signal Allocations)</li> <li>• Pn5BC (/PM (Preventative Maintenance Output) Signal Allocation)</li> </ul>

Refer to the following section for details.

 6.1.2 Output Signal Allocations on page 6-6

## 9.5 Alarm Tracing

Alarm tracing records data in the SERVOPACK from before and after an alarm occurs. This data helps you to isolate the cause of the alarm.

You can display the data recorded in the SERVOPACK as a trace waveform on the SigmaWin+.

### Information

- Alarms that occur when the power supply is turned ON are not recorded.
- Alarms that occur during the recording of alarm trace data are not recorded.
- Alarms that occur while utility functions are being executed are not recorded.

### 9.5.1 Data for Which Alarm Tracing Is Performed

Two types of data are recorded for alarm tracing: numeric data and I/O signal ON/OFF data.

Numeric Data	ON/OFF Data
Torque reference	ALM
Feedback speed	Servo ON command (/S-ON)
Reference speed	Proportional control command (/P-CON)
Position reference speed	Forward torque command (/P-CL)
Position deviation	Reverse torque command (/N-CL)
Main circuit bus voltage	G-SEL1 signal (/G-SEL1)
	ACON

### 9.5.2 Applicable Tools

The following table lists the tools that you can use to perform alarm tracing and the applicable tool functions.

Tool	Function	Operating Procedure Reference
Digital Operator	You cannot display alarm tracing data from the Digital Operator.	
SigmaWin+	<b>Alarm - Alarm Tracing</b>	 Engineering Tool SigmaWin+ Operation Manual (Manual No.: SIET S800001 34)

# Maintenance

# 10

This chapter provides information on the meaning of, causes of, and corrections for alarms and warnings.

## **10.1 Inspections and Part Replacement . . . . . 10-2**

- 10.1.1 Inspections . . . . . 10-2
- 10.1.2 Guidelines for Part Replacement . . . . . 10-2
- 10.1.3 Replacing the Battery . . . . . 10-3

## **10.2 Alarm Displays . . . . . 10-5**

- 10.2.1 List of Alarms . . . . . 10-5
- 10.2.2 Troubleshooting Alarms . . . . . 10-10
- 10.2.3 Resetting Alarms . . . . . 10-38
- 10.2.4 Displaying the Alarm History . . . . . 10-39
- 10.2.5 Clearing the Alarm History . . . . . 10-40
- 10.2.6 Resetting Motor Type Alarms . . . . . 10-41

## **10.3 Warning Displays . . . . . 10-42**

- 10.3.1 List of Warnings . . . . . 10-42
- 10.3.2 Troubleshooting Warnings . . . . . 10-44

## **10.4 Monitoring Communications Data during Alarms or Warnings . . 10-51**

## **10.5 Troubleshooting Based on the Operation and Conditions of the Servomotor . . . . . 10-52**

# 10.1 Inspections and Part Replacement

This section describes inspections and part replacement for SERVOPACKs.

## 10.1.1 Inspections

Perform the inspections given in the following table at least once every year for the SERVO-PACK. Daily inspections are not required.

Item	Frequency	Inspection	Correction
Exterior	At least once a year	Check for dust, dirt, and oil on the surfaces.	Clean with compressed air or a cloth.
Loose Screws		Check for loose terminal block and connector screws and for other loose parts.	Tighten any loose screws or other loose parts.

## 10.1.2 Guidelines for Part Replacement

The following electric or electronic parts are subject to mechanical wear or deterioration over time. Use one of the following methods to check the standard replacement period.

- Use the service life prediction function of the SERVOPACK.  
Refer to the following section for information on service life predictions.

 9.4 Monitoring Product Life on page 9-14

- Use the following table.

Part	Standard Replacement Period	Remarks
Cooling Fan	4 to 5 years	The standard replacement periods given on the left are for the following operating conditions. • Surrounding air temperature: Annual average of 30°C • Load factor: 80% max. • Operation rate: 20 hours/day max.
Electrolytic Capacitor	10 years	
Relays	100,000 power ON operations	Power ON frequency: Once an hour
Battery	3 years without power supplied	Surrounding temperature without power supplied: 20°C

When any standard replacement period is close to expiring, contact your Yaskawa representative. After an examination of the part in question, we will determine whether the part should be replaced.



Important

The parameters of any SERVOPACKs that are sent to Yaskawa for part replacement are reset to the factory settings before they are returned to you. Always keep a record of the parameter settings. And, always confirm that the parameters are properly set before starting operation.



## 10.1.3 Replacing the Battery

If the battery voltage drops to approximately 2.7 V or less, an A.830 alarm (Encoder Battery Alarm) or an A.930 warning (Encoder Battery Warning) will be displayed.

If this alarm or warning is displayed, the battery must be replaced. Refer to the following section for the battery replacement procedure.

 *Battery Replacement Procedure on page 10-3*

### Battery Alarm/Warning Selection

Whether to display an alarm or a warning is determined by the setting of Pn008 = n.□□□X (Low Battery Voltage Alarm/Warning Selection).

Parameter	Meaning	When Enabled	Classification
Pn008	n.□□□0 (default setting)	After restart	Setup
	n.□□□1		

- Pn008 = n.□□□0
- The ALM (Servo Alarm) signal is output for up to five seconds when the control power supply is turned ON, and then the battery voltage is monitored for four seconds. No alarm will be displayed even if the battery voltage drops below the specified value after these four seconds.
- Pn008 = n.□□□1  
The ALM (Servo Alarm) signal is output for up to five seconds when the control power supply is turned ON, and then the battery voltage is monitored continuously.

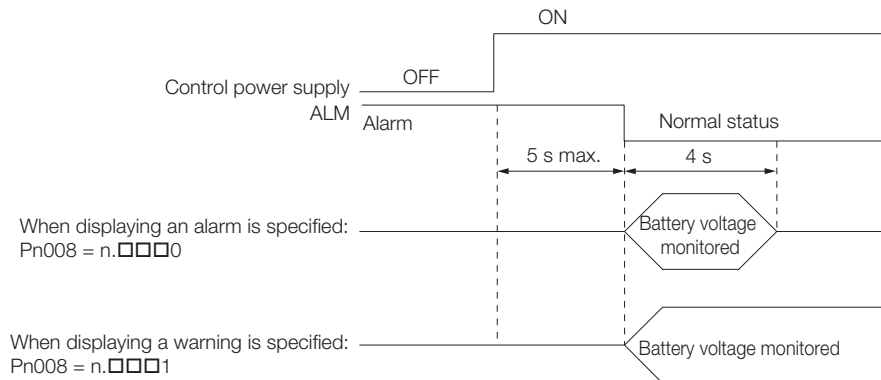

### Battery Replacement Procedure

#### ◆ When Installing a Battery on the Host Controller

1. Turn ON only the control power supply to the SERVOPACK.
2. Remove the old battery and mount a new battery.
3. Turn OFF the control power supply to the SERVOPACK to clear the A.830 alarm (Absolute Encoder Battery Error).
4. Turn ON the control power supply to the SERVOPACK again.
5. Make sure that the alarm has been cleared and that the SERVOPACK operates normally.

◆ When Using an Encoder Cable with a Battery Case

1. Turn ON only the control power supply to the SERVOPACK.

 If you remove the Battery or disconnect the Encoder Cable while the control power supply to the SERVOPACK is OFF, the absolute encoder data will be lost.

Important

2. Open the cover of the Battery Case.

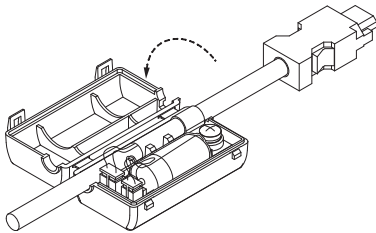

3. Remove the old Battery and mount a new Battery.

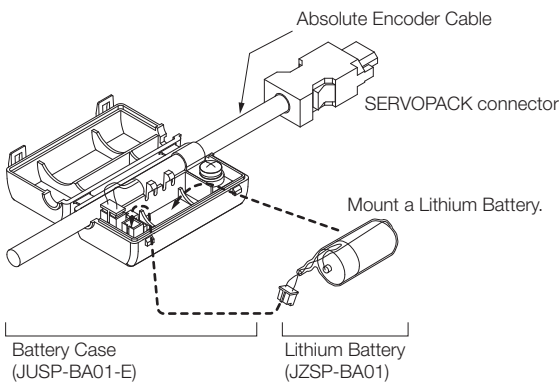

4. Close the cover of the Battery Case.

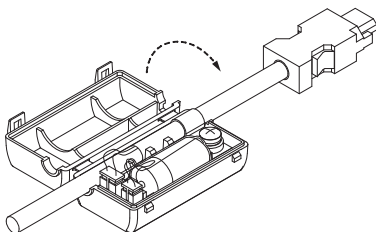

5. Turn OFF the power supply to the SERVOPACK to clear the A.830 alarm (Absolute Encoder Battery Error).
6. Turn ON the power supply to the SERVOPACK.
7. Make sure that the alarm has been cleared and that the SERVOPACK operates normally.

## 10.2 Alarm Displays

If an error occurs in the SERVOPACK, an alarm number will be displayed on the panel display. However, if  $\square\square-\square\square$  appears on the panel display, the display will indicate a SERVOPACK system error. Replace the SERVOPACK.

If there is an alarm, the display will change in the following order.

Example: Alarm A.E60

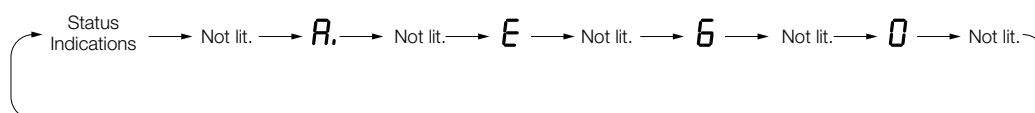

This section provides a list of the alarms that may occur and the causes of and corrections for those alarms.

### 10.2.1 List of Alarms

The following alarm tables gives the alarm name, alarm meaning, alarm stopping method, and alarm reset possibility in order of the alarm numbers.

#### Servomotor Stopping Method for Alarms

Refer to the following section for information on the stopping method for alarms.

5.13.2 Servomotor Stopping Method for Alarms on page 5-39

#### Alarm Reset Possibility

Yes: You can use an alarm reset to clear the alarm. However, this assumes that the cause of the alarm has been removed.

No: You cannot clear the alarm.

#### Alarms for Both Axes

If “All Axes” is given below the alarm number, the alarm applies to both axes. If an alarm occurs for one axis, the same alarm status will occur for the other axis.

#### List of Alarms

Alarm Number	Alarm Name	Alarm Meaning	Servo-motor Stopping Method	Alarm Reset Possible?
A.020	Parameter Checksum Error	There is an error in the parameter data in the SERVOPACK.	Gr.1	No
A.021 All Axes	Parameter Format Error	There is an error in the parameter data format in the SERVOPACK.	Gr.1	No
A.022 All Axes	System Checksum Error	There is an error in the parameter data in the SERVOPACK.	Gr.1	No
A.024	System Alarm	An internal program error occurred in the SERVOPACK.	Gr.1	No
A.025	System Alarm	An internal program error occurred in the SERVOPACK.	Gr.1	No
A.030 All Axes	Main Circuit Detector Error	There is an error in the detection data for the main circuit.	Gr.1	Yes

Continued on next page.

10.2 Alarm Displays

10.2.1 List of Alarms

Continued from previous page.

Alarm Number	Alarm Name	Alarm Meaning	Servo-motor Stopping Method	Alarm Reset Possible?
A.040	Parameter Setting Error	A parameter setting is outside of the setting range.	Gr. 1	No
A.042	Parameter Combination Error	The combination of some parameters exceeds the setting range.	Gr. 1	No
A.04A	Parameter Setting Error 2	There is an error in the bank members or bank data settings.	Gr. 1	No
A.050	Combination Error	The capacities of the SERVOPACK and Servomotor do not match.	Gr. 1	Yes
A.051	Unsupported Device Alarm	An unsupported device was connected.	Gr. 1	No
A.070	Motor Type Change Detected	The connected motor is a different type of motor from the previously connected motor.	Gr. 1	No
A.080	Linear Encoder Pitch Setting Error	The setting of Pn282 (Linear Encoder Pitch) has not been changed from the default setting.	Gr. 1	No
A.0b0	Invalid Servo ON Command Alarm	The SV_ON (Servo ON) command was sent from the host controller after a utility function that turns ON the Servomotor was executed.	Gr. 1	Yes
A.100	Overcurrent Detected	An overcurrent flowed through the power transformer or the heat sink overheated.	Gr. 1	No
A.101	Motor Overcurrent Detected	The current to the motor exceeded the allowable current.	Gr. 1	No
A.300 All Axes	Regeneration Error	There is an error related to regeneration.	Gr. 1	Yes
A.320 All Axes	Regenerative Overload	A regenerative overload occurred.	Gr.2	Yes
A.330 All Axes	Main Circuit Power Supply Wiring Error	<ul style="list-style-type: none"> <li>The AC power supply input setting or DC power supply input setting is not correct.</li> <li>The power supply wiring is not correct.</li> </ul>	Gr. 1	Yes
A.400 All Axes	Overvoltage	The main circuit DC voltage is too high.	Gr. 1	Yes
A.410 All Axes	Undervoltage	The main circuit DC voltage is too low.	Gr.2	Yes
A.510	Overspeed	The motor exceeded the maximum speed.	Gr. 1	Yes
A.520	Vibration Alarm	Abnormal oscillation was detected in the motor speed.	Gr. 1	Yes
A.521	Autotuning Alarm	Vibration was detected during autotuning for the tuning-less function.	Gr. 1	Yes
A.550	Maximum Speed Setting Error	The setting of Pn385 (Maximum Motor Speed) is greater than the maximum motor speed.	Gr. 1	Yes
A.710	Instantaneous Overload	The Servomotor was operating for several seconds to several tens of seconds under a torque that largely exceeded the rating.	Gr.2	Yes
A.720	Continuous Overload	The Servomotor was operating continuously under a torque that exceeded the rating.	Gr. 1	Yes
A.730 A.731	Dynamic Brake Overload	When the dynamic brake was applied, the rotational or linear kinetic energy exceeded the capacity of the dynamic brake resistor.	Gr. 1	Yes
A.740 All Axes	Inrush Current Limiting Resistor Overload	The main circuit power supply was frequently turned ON and OFF.	Gr. 1	Yes
A.7A1 All Axes	Internal Temperature Error 1 (Control Board Temperature Error)	The surrounding temperature of the control PCB is abnormal.	Gr.2	Yes

Continued on next page.

Continued from previous page.

Alarm Number	Alarm Name	Alarm Meaning	Servo-motor Stopping Method	Alarm Reset Possible?
A.7A2 All Axes	Internal Temperature Error 2 (Power Board Temperature Error)	The surrounding temperature of the power PCB is abnormal.	Gr.2	Yes
A.7A3	Internal Temperature Sensor Error	An error occurred in the temperature sensor circuit.	Gr.2	No
A.7Ab All Axes	SERVOPACK Built-in Fan Stopped	The fan inside the SERVOPACK stopped.	Gr.1	Yes
A.810	Encoder Backup Alarm	The power supplies to the encoder all failed and the position data was lost.	Gr.1	No
A.820	Encoder Checksum Alarm	There is an error in the checksum results for encoder memory.	Gr.1	No
A.830	Encoder Battery Alarm	The battery voltage was lower than the specified level after the control power supply was turned ON.	Gr.1	Yes
A.840	Encoder Data Alarm	There is an internal data error in the encoder.	Gr.1	No
A.850	Encoder Overspeed	The encoder was operating at high speed when the power was turned ON.	Gr.1	No
A.860	Encoder Overheated	The internal temperature of encoder is too high.	Gr.1	No
A.861	Motor Overheated	The internal temperature of motor is too high.	Gr.1	No
A.862	Overheat Alarm	The input voltage (temperature) for the overheat protection input (TH) signal exceeded the setting of Pn61B (Overheat Alarm Level).	Gr.1	Yes
A.890	Encoder Scale Error	A failure occurred in the linear encoder.	Gr.1	No
A.891	Encoder Module Error	An error occurred in the linear encoder.	Gr.1	No
A.b33	Current Detection Error 3	An error occurred in the current detection circuit.	Gr.1	No
A.b6A	MECHATROLINK Communications ASIC Error 1	ASIC error 1 occurred in MECHATROLINK communications.	Gr.1	No
A.b6b	MECHATROLINK Communications ASIC Error 2	ASIC error 2 occurred in MECHATROLINK communications.	Gr.2	No
A.bF0 All Axes	System Alarm 0	Internal program error 0 occurred in the SERVO-PACK.	Gr.1	No
A.bF1 All Axes	System Alarm 1	Internal program error 1 occurred in the SERVO-PACK.	Gr.1	No
A.bF2 All Axes	System Alarm 2	Internal program error 2 occurred in the SERVO-PACK.	Gr.1	No
A.bF3 All Axes	System Alarm 3	Internal program error 3 occurred in the SERVO-PACK.	Gr.1	No
A.bF4 All Axes	System Alarm 4	Internal program error 4 occurred in the SERVO-PACK.	Gr.1	No
A.bF5 All Axes	System Alarm 5	Internal program error 5 occurred in the SERVO-PACK.	Gr.1	No
A.bF6 All Axes	System Alarm 6	Internal program error 6 occurred in the SERVO-PACK.	Gr.1	No
A.bF7 All Axes	System Alarm 7	Internal program error 7 occurred in the SERVO-PACK.	Gr.1	No
A.bF8 All Axes	System Alarm 8	Internal program error 8 occurred in the SERVO-PACK.	Gr.1	No
A.C10	Servomotor Out of Control	The Servomotor ran out of control.	Gr.1	Yes
A.C20	Phase Detection Error	The detection of the phase is not correct.	Gr.1	No
A.C21	Polarity Sensor Error	An error occurred in the polarity sensor.	Gr.1	No

Continued on next page.

10.2 Alarm Displays

10.2.1 List of Alarms

Continued from previous page.

Alarm Number	Alarm Name	Alarm Meaning	Servo-motor Stopping Method	Alarm Reset Possible?
A.C22	Phase Information Dis-agreement	The phase information does not match.	Gr.1	No
A.C50	Polarity Detection Failure	The polarity detection failed.	Gr.1	No
A.C51	Overtravel Detected during Polarity Detection	The overtravel signal was detected during polarity detection.	Gr.1	Yes
A.C52	Polarity Detection Not Completed	The servo was turned ON before the polarity was detected.	Gr.1	Yes
A.C53	Out of Range of Motion for Polarity Detection	The travel distance exceeded the setting of Pn48E (Polarity Detection Range).	Gr.1	No
A.C54	Polarity Detection Failure 2	The polarity detection failed.	Gr.1	No
A.C80	Encoder Clear Error or Multiturn Limit Setting Error	The multiturn data for the absolute encoder was not correctly cleared or set.	Gr.1	No
A.C90	Encoder Communications Error	Communications between the encoder and SERVOPACK is not possible.	Gr.1	No
A.C91	Encoder Communications Position Data Acceleration Rate Error	An error occurred in calculating the position data of the encoder.	Gr.1	No
A.C92	Encoder Communications Timer Error	An error occurred in the communications timer between the encoder and SERVOPACK.	Gr.1	No
A.CA0	Encoder Parameter Error	The parameters in the encoder are corrupted.	Gr.1	No
A.Cb0	Encoder Echoback Error	The contents of communications with the encoder are incorrect.	Gr.1	No
A.CC0	Multiturn Limit Disagreement	Different multiturn limits have been set in the encoder and the SERVOPACK.	Gr.1	No
A.d00	Position Deviation Overflow	The setting of Pn520 (Excessive Position Deviation Alarm Level) was exceeded by the position deviation while the servo was ON.	Gr.1	Yes
A.d01	Position Deviation Overflow Alarm at Servo ON	The servo was turned ON after the position deviation exceeded the setting of Pn526 (Excessive Position Deviation Alarm Level at Servo ON) while the servo was OFF.	Gr.1	Yes
A.d02	Position Deviation Overflow Alarm for Speed Limit at Servo ON	If position deviation remains in the deviation counter, the setting of Pn529 or Pn584 (Speed Limit Level at Servo ON) limits the speed when the servo is turned ON. This alarm occurs if a position reference is input and the setting of Pn520 (Excessive Position Deviation Alarm Level) is exceeded before the limit is cleared.	Gr.2	Yes
A.d30	Position Data Overflow	The position feedback data exceeded $\pm 1,879,048,192$ .	Gr.1	No
A.E02 [All Axes]	MECHATROLINK Internal Synchronization Error 1	A synchronization error occurred during MECHATROLINK communications with the SERVOPACK.	Gr.1	Yes
A.E40 [All Axes]	MECHATROLINK Transmission Cycle Setting Error	The setting of the MECHATROLINK communications transmission cycle is not correct.	Gr.2	Yes
A.E41 [All Axes]	MECHATROLINK Communications Data Size Setting Error	The setting of the MECHATROLINK communications data size is not correct.	Gr.2	Yes
A.E42 [All Axes]	MECHATROLINK Station Address Setting Error	The setting of the MECHATROLINK station address is not correct.	Gr.2	No

Continued on next page.

Continued from previous page.

Alarm Number	Alarm Name	Alarm Meaning	Servo-motor Stopping Method	Alarm Reset Possible?
A.E50*	MECHATROLINK Synchronization Error	A synchronization error occurred during MECHATROLINK communications.	Gr.2	Yes
A.E51 All Axes	MECHATROLINK Synchronization Failed	Synchronization failed during MECHATROLINK communications.	Gr.2	Yes
A.E60*	Reception Error in MECHATROLINK Communications	Communications errors occurred continuously during MECHATROLINK communications.	Gr.2	Yes
A.E61 All Axes	Synchronization Interval Error in MECHATROLINK Transmission Cycle	An error occurred in the transmission cycle during MECHATROLINK communications.	Gr.2	Yes
A.E63 All Axes	MECHATROLINK Synchronization Frame Not Received	Synchronization frames were continuously not received during MECHATROLINK communications.	Gr.2	Yes
A.Ed1	Command Execution Timeout	A timeout error occurred for a MECHATROLINK command.	Gr.2	Yes
A.F10 All Axes	Power Supply Line Open Phase	The voltage was low for more than one second for phase R, S, or T when the main power supply was ON.	Gr.2	Yes
FL-1* All Axes	System Alarm	An internal program error occurred in the SERVOPACK.	-	No
FL-2* All Axes				
FL-3* All Axes				
FL-4* All Axes				
FL-5* All Axes				
FL-6* All Axes				
CPF00 All Axes	Digital Operator Communications Error 1	Communications were not possible between the Digital Operator (model: JUSP-OP05A-1-E) and the SERVOPACK (e.g., a CPU error occurred).	-	No
CPF01 All Axes	Digital Operator Communications Error 2			

\* These alarms are not stored in the alarm history. They are only displayed on the panel display.

## 10.2.2 Troubleshooting Alarms

The causes of and corrections for the alarms are given in the following table. Contact your Yaskawa representative if you cannot solve a problem with the correction given in the table.

Alarm Number: Alarm Name	Possible Cause	Confirmation	Correction	Reference
A.020: Parameter Checksum Error (There is an error in the parameter data in the SER- VOPACK.)	The power supply voltage suddenly dropped.	Measure the power supply voltage.	Set the power supply voltage within the specified range, and initialize the parameter settings.	page 5-9
	The power supply was shut OFF while writing parameter settings.	Check the timing of shutting OFF the power supply.	Initialize the parameter settings and then set the parameters again.	
	The number of times that parameters were written exceeded the limit.	Check to see if the parameters were frequently changed from the host controller.	The SERVOPACK may be faulty. Replace the SERVOPACK. Reconsider the method for writing the parameters.	-
	A malfunction was caused by noise from the AC power supply, ground, static electricity, or other source.	Turn the power supply to the SERVOPACK OFF and ON again. If the alarm still occurs, noise may be the cause.	Implement countermeasures against noise.	page 4-6
	Gas, water drops, or cutting oil entered the SERVOPACK and caused failure of the internal components.	Check the installation conditions.	The SERVOPACK may be faulty. Replace the SERVOPACK.	-
	A failure occurred in the SERVOPACK.	Turn the power supply to the SERVOPACK OFF and ON again. If the alarm still occurs, the SERVOPACK may have failed.	The SERVOPACK may be faulty. Replace the SERVOPACK.	-
A.021: Parameter Format Error (There is an error in the parameter data format in the SERVOPACK.)	The software version of the SERVOPACK that caused the alarm is older than the software version of the parameters specified to write.	Read the product information to see if the software versions are the same. If they are different, it could be the cause of the alarm.	Write the parameters from another SERVOPACK with the same model and the same software version, and then turn the power OFF and ON again.	page 9-2
	A failure occurred in the SERVOPACK.	-	The SERVOPACK may be faulty. Replace the SERVOPACK.	-
A.022: System Checksum Error (There is an error in the parameter data in the SERVOPACK.)	The power supply voltage suddenly dropped.	Measure the power supply voltage.	The SERVOPACK may be faulty. Replace the SERVOPACK.	-
	The power supply was shut OFF while setting a utility function.	Check the timing of shutting OFF the power supply.	The SERVOPACK may be faulty. Replace the SERVOPACK.	-
	A failure occurred in the SERVOPACK.	Turn the power supply to the SERVOPACK OFF and ON again. If the alarm still occurs, the SERVOPACK may have failed.	The SERVOPACK may be faulty. Replace the SERVOPACK.	-

Continued on next page.



Continued from previous page.

Alarm Number: Alarm Name	Possible Cause	Confirmation	Correction	Reference
<b>A.024:</b> System Alarm (An internal program error occurred in the SERVOPACK.)	A failure occurred in the SERVOPACK.	–	The SERVOPACK may be faulty. Replace the SERVOPACK.	–
<b>A.025:</b> System Alarm (An internal program error occurred in the SERVOPACK.)	A failure occurred in the SERVOPACK.	–	The SERVOPACK may be faulty. Replace the SERVOPACK.	–
<b>A.030:</b> Main Circuit Detector Error	A failure occurred in the SERVOPACK.	–	The SERVOPACK may be faulty. Replace the SERVOPACK.	–
<b>A.040:</b> Parameter Setting Error (A parameter setting is outside of the setting range.)	The SERVOPACK and Servomotor capacities do not match each other.	Check the combination of the SERVOPACK and Servomotor capacities.	Select a proper combination of SERVOPACK and Servomotor capacities.	page 1-9
	A failure occurred in the SERVOPACK.	–	The SERVOPACK may be faulty. Replace the SERVOPACK.	–
	A parameter setting is outside of the setting range.	Check the setting ranges of the parameters that have been changed.	Set the parameters to values within the setting ranges.	–
	The electronic gear ratio is outside of the setting range.	Check the electronic gear ratio. The ratio must be within the following range: $0.001 < (Pn20E/Pn210) < 64,000$ .	Set the electronic gear ratio in the following range: $0.001 < (Pn20E/Pn210) < 64,000$ .	page 5-44
	A pin number that does not exist on the SERVOPACK was allocated in Pn590 to Pn5BC. (An alarm will not occur, however, if the signal is disabled.)	For input signals (Pn590 to Pn599), make sure that the allocated pin numbers are between 003 and 014. For output signals (Pn5B0 to Pn5BC), make sure that the allocated pin numbers are between 023 and 031.	Allocate pins that actually exist in Pn590 to Pn5BC.	page 6-4, page 6-8

Continued on next page.

10.2 Alarm Displays

10.2.2 Troubleshooting Alarms

Continued from previous page.

Alarm Number: Alarm Name	Possible Cause	Confirmation	Correction	Reference
A.042: Parameter Combination Error	The speed of program jogging went below the setting range when the electronic gear ratio (Pn20E/Pn210) or the Servomotor was changed.	Check to see if the detection conditions* <sup>1</sup> are satisfied.	Decrease the setting of the electronic gear ratio (Pn20E/Pn210).	page 5-44
	The speed of program jogging went below the setting range when Pn533 or Pn585 (Program Jogging Speed) was changed.	Check to see if the detection conditions* <sup>1</sup> are satisfied.	Increase the setting of Pn533 or Pn585.	page 7-14
	The movement speed of advanced autotuning went below the setting range when the electronic gear ratio (Pn20E/Pn210) or the Servomotor was changed.	Check to see if the detection conditions* <sup>2</sup> are satisfied.	Decrease the setting of the electronic gear ratio (Pn20E/Pn210).	page 5-44
A.04A: Parameter Setting Error 2	For 4-byte parameter bank members, there are two consecutive members with nothing registered.	–	Change the number of bytes for bank members to an appropriate value.	–
	The total amount of bank data exceeds 64 (Pn900 × Pn901 > 64).	–	Reduce the total amount of bank data to 64 or less.	–
A.050: Combination Error (The capacities of the SERVOPACK and Servomotor do not match.)	The SERVOPACK and Servomotor capacities do not match each other.	Confirm that the following condition is met: $1/4 \leq (\text{Servomotor capacity} / \text{SERVOPACK capacity}) \leq 4$ However, the above formula does not apply to the following products. • SGD7W-2R8A SERVOPACK and SGM7J-A5A Servomotor • SGD7W-2R8A SERVOPACK and SGM7A-A5A Servomotor	Select a proper combination of the SERVOPACK and Servomotor capacities.	page 1-9
	A failure occurred in the encoder.	Replace the encoder and check to see if the alarm still occurs.	Replace the Servomotor or encoder.	–
	A failure occurred in the SERVOPACK.	–	The SERVOPACK may be faulty. Replace the SERVOPACK.	–

Continued on next page.

Continued from previous page.

Alarm Number: Alarm Name	Possible Cause	Confirmation	Correction	Reference
A.051: Unsupported Device Alarm	The motor parameter file was not written to the linear encoder. (This applies only when not using a Serial Converter Unit.)	Check to see if the motor parameter file was written to the linear encoder.	Write the motor parameter file to the linear encoder.	page 5-18
	An unsupported Serial Converter Unit or encoder is connected to the SERVOPACK.	Check the product combination specifications.	Change to a correct combination of models.	–
A.070: Motor Type Change Detected (The connected motor is a different type of motor from the previously connected motor.)	A Rotary Servomotor was removed and a Linear Servomotor was connected.	–	Set the parameters for a Linear Servomotor and reset the motor type alarm. Then, turn the power supply to the SERVOPACK OFF and ON again.	page 10-41
	A Linear Servomotor was removed and a Rotary Servomotor was connected.	–	Set the parameters for a Rotary Servomotor and reset the motor type alarm. Then, turn the power supply to the SERVOPACK OFF and ON again.	page 10-41
A.080: Linear Encoder Pitch Setting Error	The setting of Pn282 (Linear Encoder Pitch) has not been changed from the default setting.	Check the setting of Pn282.	Correct the setting of Pn282.	page 5-17
A.0b0: Invalid Servo ON Command Alarm	The SV_ON (Servo ON) command was sent from the host controller after a utility function that turns ON the Servomotor was executed.	–	Turn the power supply to the SERVOPACK OFF and ON again. Or, execute a software reset.	page 6-34

Continued on next page.

10.2 Alarm Displays

10.2.2 Troubleshooting Alarms

Continued from previous page.

Alarm Number: Alarm Name	Possible Cause	Confirmation	Correction	Reference
A.100: Overcurrent Detected (An overcurrent flowed through the power trans- former or the heat sink overheated.)	The Main Circuit Cable is not wired correctly or there is faulty contact.	Check the wiring.	Correct the wiring.	page 4-21
	There is a short-circuit or ground fault in a Main Circuit Cable.	Check for short-circuits across Servomotor phases U, V, and W, or between the ground and Servomotor phases U, V, and W.	The cable may be short-circuited. Replace the cable.	
	There is a short-circuit or ground fault inside the Servomotor.	Check for short-circuits across Servomotor phases U, V, and W, or between the ground and Servomotor phases U, V, or W.	The Servomotor may be faulty. Replace the Servomotor.	
	There is a short-circuit or ground fault inside the SERVOPACK.	Check for short-circuits across the Servomotor connection terminals U, V, and W on the SERVOPACK, or between the ground and terminals U, V, or W.	The SERVOPACK may be faulty. Replace the SERVOPACK.	
	The regenerative resistor is not wired correctly or there is faulty contact.	Check the wiring.	Correct the wiring.	page 4-18
	The dynamic brake (DB, emergency stop executed from the SERVOPACK) was frequently activated, or a DB overload alarm occurred.	Check the power consumed by the DB resistor to see how frequently the DB is being used. Or, check the alarm display to see if a DB overload alarm (A.730 or A.731) has occurred.	Change the SERVOPACK model, operating methods, or the mechanisms so that the dynamic brake does not need to be used so frequently.	-
	The regenerative processing capacity was exceeded.	Check the regenerative load ratio in the SigmaWin+ Motion Monitor Tab Page to see how frequently the regenerative resistor is being used.	Recheck the operating conditions and load.	*3
	The SERVOPACK regenerative resistance is too small.	Check the regenerative load ratio in the SigmaWin+ Motion Monitor Tab Page to see how frequently the regenerative resistor is being used.	Change the regenerative resistance to a value larger than the SERVOPACK minimum allowable resistance.	

Continued on next page.

Continued from previous page.

Alarm Number: Alarm Name	Possible Cause	Confirmation	Correction	Reference
A.100: Overcurrent Detected (An overcurrent flowed through the power trans- former or the heat sink overheated.)	A heavy load was applied while the Ser- vomotor was stopped or running at a low speed.	Check to see if the operating conditions exceed Servo Drive specifications.	Reduce the load applied to the Servomotor. Or, increase the operating speed.	–
	A malfunction was caused by noise.	Improve the noise envi- ronment, e.g. by improving the wiring or installation conditions, and check to see if the alarm still occurs.	Implement countermea- sures against noise, such as correct wiring of the FG. Use an FG wire size equivalent to the SERVO- PACK's main circuit wire size.	–
	A failure occurred in the SERVOPACK.	–	Turn the power supply to the SERVOPACK OFF and ON again. If the alarm still occurs, the SERVOPACK may be faulty. Replace the SERVOPACK.	–
A.101: Motor Overcur- rent Detected (The current to the motor exceeded the allowable cur- rent.)	The Main Circuit Cable is not wired correctly or there is faulty contact.	Check the wiring.	Correct the wiring.	page 4-21
	There is a short-circuit or ground fault in a Main Circuit Cable.	Check for short-circuits across cable phases U, V, and W, or between the ground and cable phases U, V, and W.	The cable may be short- circuited. Replace the cable.	
	There is a short-circuit or ground fault inside the Servomotor.	Check for short-circuits across Servomotor phases U, V, and W, or between the ground and Servomotor phases U, V, or W.	The Servomotor may be faulty. Replace the Servo- motor.	
	There is a short-circuit or ground fault inside the SERVOPACK.	Check for short-circuits across the Servomotor connection terminals U, V, and W on the SER- VOPACK, or between the ground and termi- nals U, V, or W.	The SERVOPACK may be faulty. Replace the SER- VOPACK.	
	A heavy load was applied while the Ser- vomotor was stopped or running at a low speed.	Check to see if the operating conditions exceed Servo Drive specifications.	Reduce the load applied to the Servomotor. Or, increase the operating speed.	
A.101: Motor Overcurrent Detected (The current to the motor exceeded the allowable current.)	A malfunction was caused by noise.	Improve the noise envi- ronment, e.g. by improving the wiring or installation conditions, and check to see if the alarm still occurs.	Implement countermea- sures against noise, such as correct wiring of the FG. Use an FG wire size equivalent to the SERVO- PACK's main circuit wire size.	–
	A failure occurred in the SERVOPACK.	–	Turn the power supply to the SERVOPACK OFF and ON again. If the alarm still occurs, the SERVOPACK may be faulty. Replace the SERVOPACK.	–

Continued on next page.

10.2 Alarm Displays

10.2.2 Troubleshooting Alarms

Continued from previous page.

Alarm Number: Alarm Name	Possible Cause	Confirmation	Correction	Reference
A.300: Regeneration Error	The jumper between the regenerative resistor terminals (B2 and B3) was removed.	Check to see if the jumper is connected between power supply terminals B2 and B3.*4	Correctly connect a jumper.	page 4-18
	The External Regenerative Resistor is not wired correctly, or was removed or disconnected.	Check the wiring of the External Regenerative Resistor.*4	Correct the wiring of the External Regenerative Resistor.	
	A failure occurred in the SERVOPACK.	–	While the main circuit power supply is OFF, turn the control power supply to the SERVOPACK OFF and ON again. If the alarm still occurs, the SERVOPACK may be faulty. Replace the SERVOPACK.	–
A.320: Regenerative Overload	The power supply voltage exceeded the specified range.	Measure the power supply voltage.	Set the power supply voltage within the specified range.	–
	The external regenerative resistance value or regenerative resistor capacity is too small, or there has been a continuous regeneration state.	Check the operating conditions or the capacity.	Change the regenerative resistance value or capacity. Reconsider the operating conditions.	*3
	There was a continuous regeneration state because a negative load was continuously applied.	Check the load applied to the Servomotor during operation.	Reconsider the system including the servo, machine, and operating conditions.	–
	The setting of Pn600 (Regenerative Resistor Capacity) is smaller than the capacity of the External Regenerative Resistor.	Check to see if a Regenerative Resistor is connected and check the setting of Pn600.	Correct the setting of Pn600.	page 5-54
	The setting of Pn603 (Regenerative Resistor Capacity) is smaller than the capacity of the External Regenerative Resistor.	Check to see if a Regenerative Resistor is connected and check the setting of Pn603.	Correct the setting of Pn603.	page 5-54
	The external regenerative resistance is too high.	Check the regenerative resistance.	Change the regenerative resistance to a correct value or use an External Regenerative Resistor of an appropriate capacity.	*3
	A failure occurred in the SERVOPACK.	–	The SERVOPACK may be faulty. Replace the SERVOPACK.	–

Continued on next page.

Continued from previous page.

Alarm Number: Alarm Name	Possible Cause	Confirmation	Correction	Reference
<b>A.330:</b> Main Circuit Power Supply Wiring Error (Detected when the main circuit power supply is turned ON.)	The regenerative resistor was disconnected when the SERVOPACK power supply voltage was high.	Measure the resistance of the regenerative resistor using a measuring instrument.	If you are using the regenerative resistor built into the SERVOPACK, replace the SERVOPACK. If you are using an External Regenerative Resistor, replace the External Regenerative Resistor.	–
	DC power was supplied when an AC power supply input was specified in the settings.	Check the power supply to see if it is a DC power supply.	Correct the power supply setting to match the actual power supply.	page 5-13
	AC power was supplied when a DC power supply input was specified in the settings.	Check the power supply to see if it is an AC power supply.	Correct the power supply setting to match the actual power supply.	
	A failure occurred in the SERVOPACK.	–	The SERVOPACK may be faulty. Replace the SERVOPACK.	–
<b>A.400:</b> Overvoltage (Detected in the main circuit power supply section of the SERVOPACK.)	The power supply voltage exceeded the specified range.	Measure the power supply voltage.	Set the AC/DC power supply voltage within the specified range.	–
	The power supply is not stable or was influenced by a lightning surge.	Measure the power supply voltage.	Improve the power supply conditions, install a surge absorber, and then turn the power supply OFF and ON again. If the alarm still occurs, the SERVOPACK may be faulty. Replace the SERVOPACK.	–
	The voltage for AC power supply was too high during acceleration or deceleration.	Check the power supply voltage and the speed and torque during operation.	Set the AC power supply voltage within the specified range.	–
	The external regenerative resistance is too high for the operating conditions.	Check the operating conditions and the regenerative resistance.	Select a regenerative resistance value that is appropriate for the operating conditions and load.	*3
	The moment of inertia ratio or mass ratio exceeded the allowable value.	Check to see if the moment of inertia ratio or mass ratio is within the allowable range.	Increase the deceleration time, or reduce the load.	–
A failure occurred in the SERVOPACK.	–	While the main circuit power supply is OFF, turn the control power supply to the SERVOPACK OFF and ON again. If the alarm still occurs, the SERVOPACK may be faulty. Replace the SERVOPACK.	–	

Continued on next page.

10.2 Alarm Displays

10.2.2 Troubleshooting Alarms

Continued from previous page.

Alarm Number: Alarm Name	Possible Cause	Confirmation	Correction	Reference
A.410: Undervoltage (Detected in the main circuit power supply section of the SERVOPACK.)	The power supply voltage went below the specified range.	Measure the power supply voltage.	Set the power supply voltage within the specified range.	-
	The power supply voltage dropped during operation.	Measure the power supply voltage.	Increase the power supply capacity.	-
	A momentary power interruption occurred.	Measure the power supply voltage.	If you have changed the setting of Pn509 (Momentary Power Interruption Hold Time), decrease the setting.	page 6-17
	The SERVOPACK fuse is blown out.	-	Replace the SERVOPACK and connect a reactor to the DC reactor terminals (⊖1 and ⊖2) on the SERVOPACK.	-
	A failure occurred in the SERVOPACK.	-	The SERVOPACK may be faulty. Replace the SERVOPACK.	-
A.510: Overspeed (The motor exceeded the maximum speed.)	The order of phases U, V, and W in the motor wiring is not correct.	Check the wiring of the Servomotor.	Make sure that the Servomotor is correctly wired.	-
	A reference value that exceeded the overspeed detection level was input.	Check the input reference.	Reduce the reference value. Or, adjust the gain.	-
	The motor exceeded the maximum speed.	Check the waveform of the motor speed.	Reduce the speed reference input gain and adjust the servo gain. Or, reconsider the operating conditions.	-
	A failure occurred in the SERVOPACK.	-	The SERVOPACK may be faulty. Replace the SERVOPACK.	-
A.520: Vibration Alarm	Abnormal oscillation was detected in the motor speed.	Check for abnormal motor noise, and check the speed and torque waveforms during operation.	Reduce the motor speed. Or, reduce the setting of Pn100 (Speed Loop Gain).	page 8-82
	The setting of Pn103 (Moment of Inertia Ratio) is greater than the actual moment of inertia or was greatly changed.	Check the moment of inertia ratio or mass ratio.	Set Pn103 (Moment of Inertia Ratio) to an appropriate value.	page 8-16
	The vibration detection level (Pn312 or Pn384) is not suitable.	Check that the vibration detection level (Pn312 or Pn384) is suitable.	Set a suitable vibration detection level (Pn312 or Pn384).	page 6-37

Continued on next page.



Continued from previous page.

Alarm Number: Alarm Name	Possible Cause	Confirmation	Correction	Reference
A.521: Autotuning Alarm (Vibration was detected while executing the custom tuning, Easy FFT, or the tuning-less function.)	The Servomotor vibrated considerably while performing the tuning-less function.	Check the waveform of the motor speed.	Reduce the load so that the moment of inertia ratio is within the allowable value. Or increase the load level or reduce the rigidity level in the tuning-less level settings.	page 8-13
	The Servomotor vibrated considerably while performing custom tuning or Easy FFT.	Check the waveform of the motor speed.	Check the operating procedure of corresponding function and implement corrections.	page 8-43, page 8-97
A.550: Maximum Speed Setting Error	The setting of Pn385 (Maximum Motor Speed) is greater than the maximum speed.	Check the setting of Pn385, and the upper limits of the maximum motor speed setting and the encoder output resolution setting.	Set Pn385 to a value that does not exceed the maximum motor speed.	page 6-20
A.710: Instantaneous Overload A.720: Continuous Overload	The wiring is not correct or there is a faulty connection in the motor or encoder wiring.	Check the wiring.	Make sure that the Servomotor and encoder are correctly wired.	page 4-21
	Operation was performed that exceeded the overload protection characteristics.	Check the motor overload characteristics and Run command.	Reconsider the load and operating conditions. Or, increase the motor capacity.	–
	An excessive load was applied during operation because the Servomotor was not driven due to mechanical problems.	Check the operation reference and motor speed.	Correct the mechanical problem.	–
	There is an error in the setting of Pn282 (Linear Encoder Pitch).	Check the setting of Pn282.	Correct the setting of Pn282.	page 5-17
	There is an error in the setting of Pn080 = n.□□X□ (Motor Phase Selection).	Check the setting of Pn080 = n.□□X□.	Set Pn080 = n.□□X□ to an appropriate value.	page 5-22
	A failure occurred in the SERVOPACK.	–	The SERVOPACK may be faulty. Replace the SERVOPACK.	–
A.730 and A.731: Dynamic Brake Overload (An excessive power consumption by the dynamic brake was detected.)	The Servomotor was rotated by an external force.	Check the operation status.	Implement measures to ensure that the motor will not be rotated by an external force.	–
	When the Servomotor was stopped with the dynamic brake, the rotational or linear kinetic energy exceeded the capacity of the dynamic brake resistor.	Check the power consumed by the DB resistor to see how frequently the DB is being used.	Reconsider the following: <ul style="list-style-type: none"> <li>• Reduce the Servomotor command speed.</li> <li>• Decrease the moment of inertia ratio or mass ratio.</li> <li>• Reduce the frequency of stopping with the dynamic brake.</li> </ul>	–
	A failure occurred in the SERVOPACK.	–	The SERVOPACK may be faulty. Replace the SERVOPACK.	–

Continued on next page.

10.2 Alarm Displays

10.2.2 Troubleshooting Alarms

Continued from previous page.

Alarm Number: Alarm Name	Possible Cause	Confirmation	Correction	Reference
A.740: Inrush Current Limiting Resistor Overload (The main circuit power supply was frequently turned ON and OFF.)	The allowable frequency of the inrush current limiting resistor was exceeded when the main circuit power supply was turned ON and OFF.	–	Reduce the frequency of turning the main circuit power supply ON and OFF.	–
	A failure occurred in the SERVOPACK.	–	The SERVOPACK may be faulty. Replace the SERVOPACK.	–
A.7A1: Internal Temperature Error 1 (Control Board Temperature Error)	The surrounding temperature is too high.	Check the surrounding temperature using a thermometer. Or, check the operating status with the SERVOPACK installation environment monitor.	Decrease the surrounding temperature by improving the SERVOPACK installation conditions.	page 3-6
	An overload alarm was reset by turning OFF the power supply too many times.	Check the alarm display to see if there is an overload alarm.	Change the method for resetting the alarm.	–
	There was an excessive load or operation was performed that exceeded the regenerative processing capacity.	Use the accumulated load ratio to check the load during operation, and use the regenerative load ratio to check the regenerative processing capacity.	Reconsider the load and operating conditions.	–
	The SERVOPACK installation orientation is not correct or there is insufficient space around the SERVOPACK.	Check the SERVOPACK installation conditions.	Install the SERVOPACK according to specifications.	page 3-3, page 3-5
	A failure occurred in the SERVOPACK.	–	The SERVOPACK may be faulty. Replace the SERVOPACK.	–

Continued on next page.

Continued from previous page.

Alarm Number: Alarm Name	Possible Cause	Confirmation	Correction	Reference
A.7A2: Internal Temperature Error 2 (Power Board Temperature Error)	The surrounding temperature is too high.	Check the surrounding temperature using a thermometer. Or, check the operating status with the SERVOPACK installation environment monitor.	Decrease the surrounding temperature by improving the SERVOPACK installation conditions.	page 3-6
	An overload alarm was reset by turning OFF the power supply too many times.	Check the alarm display to see if there is an overload alarm.	Change the method for resetting the alarm.	–
	There was an excessive load or operation was performed that exceeded the regenerative processing capacity.	Use the accumulated load ratio to check the load during operation, and use the regenerative load ratio to check the regenerative processing capacity.	Reconsider the load and operating conditions.	–
	The SERVOPACK installation orientation is not correct or there is insufficient space around the SERVOPACK.	Check the SERVOPACK installation conditions.	Install the SERVOPACK according to specifications.	page 3-3, page 3-5
	A failure occurred in the SERVOPACK.	–	The SERVOPACK may be faulty. Replace the SERVOPACK.	–
A.7A3: Internal Temperature Sensor Error (An error occurred in the temperature sensor circuit.)	A failure occurred in the SERVOPACK.	–	The SERVOPACK may be faulty. Replace the SERVOPACK.	–
A.7Ab: SERVOPACK Built-in Fan Stopped	The fan inside the SERVOPACK stopped.	Check for foreign matter inside the SERVOPACK.	Remove foreign matter from the SERVOPACK. If the alarm still occurs, the SERVOPACK may be faulty. Replace the SERVOPACK.	–
A.810: Encoder Backup Alarm (Detected at the encoder, but only when an absolute encoder is used.)	The power to the absolute encoder was turned ON for the first time.	Check to see if the power supply was turned ON for the first time.	Set up the encoder.	page 5-48
	The Encoder Cable was disconnected and then connected again.	Check to see if the power supply was turned ON for the first time.	Check the encoder connection and set up the encoder.	
	Power is not being supplied both from the control power supply (+5 V) from the SERVOPACK and from the battery power supply.	Check the encoder connector battery and the connector status.	Replace the battery or implement similar measures to supply power to the encoder, and set up the encoder.	–
	A failure occurred in the absolute encoder.	–	If the alarm still occurs after setting up the encoder again, replace the Servomotor.	–
	A failure occurred in the SERVOPACK.	–	The SERVOPACK may be faulty. Replace the SERVOPACK.	–

Continued on next page.

10.2 Alarm Displays

10.2.2 Troubleshooting Alarms

Continued from previous page.

Alarm Number: Alarm Name	Possible Cause	Confirmation	Correction	Reference
A.820: Encoder Checksum Alarm (Detected at the encoder.)	A failure occurred in the encoder.	–	<ul style="list-style-type: none"> <li>■ When Using an Absolute Encoder Set up the encoder again. If the alarm still occurs, the Servomotor may be faulty. Replace the Servomotor.</li> <li>■ When Using a Single-turn Absolute Encoder or Incremental Encoder                             <ul style="list-style-type: none"> <li>• The Servomotor may be faulty. Replace the Servomotor.</li> <li>• The linear encoder may be faulty. Replace the linear encoder.</li> </ul> </li> </ul>	page 5-48
	A failure occurred in the SERVOPACK.	–	The SERVOPACK may be faulty. Replace the SERVOPACK.	–
A.830: Encoder Battery Alarm (The absolute encoder battery voltage was lower than the specified level.)	The battery connection is faulty or a battery is not connected.	Check the battery connection.	Correct the battery connection.	page 4-22
	The battery voltage is lower than the specified value (2.7 V).	Measure the battery voltage.	Replace the battery.	page 10-3
	A failure occurred in the SERVOPACK.	–	The SERVOPACK may be faulty. Replace the SERVOPACK.	–
A.840: Encoder Data Alarm (Detected at the encoder.)	The encoder malfunctioned.	–	Turn the power supply to the SERVOPACK OFF and ON again. If the alarm still occurs, the Servomotor or linear encoder may be faulty. Replace the Servomotor or linear encoder.	–
	An error occurred in reading data from the linear encoder.	–	The linear encoder is not mounted within an appropriate tolerance. Correct the mounting of the linear encoder.	–
	Excessive speed occurred in the linear encoder.	–	Control the motor speed within the range specified by the linear encoder manufacturer and then turn ON the control power supply.	–
	The encoder malfunctioned due to noise.	–	Correct the wiring around the encoder by separating the Encoder Cable from the Servomotor Main Circuit Cable or by grounding the encoder.	–
	The polarity sensor is not wired correctly.	Check the wiring of the polarity sensor.	Correct the wiring of the polarity sensor.	–
	The polarity sensor failed.	–	Replace the polarity sensor.	–

Continued on next page.

Continued from previous page.

Alarm Number: Alarm Name	Possible Cause	Confirmation	Correction	Reference
<b>A.850:</b> Encoder Over-speed (Detected at the encoder when the control power supply is turned ON.)	Rotary Servomotor: The Servomotor speed was 200 min <sup>-1</sup> or higher when the control power supply was turned ON.	Check the motor speed when the power supply is turned ON.	Reduce the Servomotor speed to a value less than 200 min <sup>-1</sup> , and turn ON the control power supply.	–
	Linear Servomotor: The Servomotor exceeded the specified speed when the control power supply was turned ON.	Check the motor speed when the power supply is turned ON.	Control the motor speed within the range specified by the linear encoder manufacturer and then turn ON the control power supply.	–
	A failure occurred in the encoder.	–	Turn the power supply to the SERVOPACK OFF and ON again. If the alarm still occurs, the Servomotor or linear encoder may be faulty. Replace the Servomotor or linear encoder.	–
	A failure occurred in the SERVOPACK.	–	Turn the power supply to the SERVOPACK OFF and ON again. If the alarm still occurs, the SERVOPACK may be faulty. Replace the SERVOPACK.	–
<b>A.860:</b> Encoder Overheated (Detected when a Rotary Servomotor, Absolute Linear Encoder, or Direct Drive Servomotor is connected. However, this alarm is not detected for SGMCS Servomotors with Incremental Encoders.) (Detected at the encoder.)	The surrounding air temperature around the Servomotor is too high.	Measure the surrounding air temperature around the Servomotor.	Reduce the surrounding air temperature of the Servomotor to 40°C or less.	–
	The Servomotor load is greater than the rated load.	Use the accumulated load ratio to check the load.	Operate the Servo Drive so that the motor load remains within the specified range.	page 9-3
	A failure occurred in the encoder.	–	Turn the power supply to the SERVOPACK OFF and ON again. If the alarm still occurs, the Servomotor or absolute linear encoder may be faulty. Replace the Servomotor or absolute linear encoder.	–
	A failure occurred in the SERVOPACK.	–	Turn the power supply to the SERVOPACK OFF and ON again. If the alarm still occurs, the SERVOPACK may be faulty. Replace the SERVOPACK.	–

Continued on next page.

10.2 Alarm Displays

10.2.2 Troubleshooting Alarms

Continued from previous page.

Alarm Number: Alarm Name	Possible Cause	Confirmation	Correction	Reference
A.861: Motor Overheated	The surrounding temperature around the Servomotor is too high.	Measure the surrounding temperature around the Servomotor.	Reduce the surrounding air temperature of the Servomotor to 40° or less.	-
	The motor load is greater than the rated load.	Check the load with the accumulated load ratio on the Motion Monitor Tab Page on the SigmaWin+.	Operate the Servo Drive so that the motor load remains within the specified range.	page 9-3
	A failure occurred in the Serial Converter Unit.	-	Turn the power supply to the SERVOPACK OFF and ON again. If the alarm still occurs, the Serial Converter Unit may be faulty. Replace the Serial Converter Unit.	-
	A failure occurred in the SERVOPACK.	-	Turn the power supply to the SERVOPACK OFF and ON again. If the alarm still occurs, the SERVOPACK may be faulty. Replace the SERVOPACK.	-
A.862: Overheat Alarm	The surrounding temperature is too high.	Check the surrounding temperature using a thermometer.	Lower the surrounding temperature by improving the installation conditions of the Linear Servomotor or the machine.	-
	The overheat protection input signal line is disconnected or short-circuited.	Check the input voltage with the overheat protection input information on the Motion Monitor Tab Page on the SigmaWin+.	Repair the line for the overheat protection input signal.	-
	An overload alarm was reset by turning OFF the power supply too many times.	Check the alarm display to see if there is an overload alarm.	Change the method for resetting the alarm.	-
	Operation was performed under an excessive load.	Use the accumulated load ratio to check the load during operation.	Reconsider the load and operating conditions.	-
	A failure occurred in the SERVOPACK.	-	The SERVOPACK may be faulty. Replace the SERVOPACK.	-
	The temperature detection circuit in the Linear Servomotor is faulty or the sensor attached to the machine is faulty.	-	The temperature detection circuit in the Linear Servomotor may be faulty or the sensor attached to the machine may be faulty. Replace the Linear Servomotor or repair the sensor attached to the machine.	-
A.890: Encoder Scale Error	A failure occurred in the linear encoder.	-	The linear encoder may be faulty. Replace the linear encoder.	-
A.891: Encoder Module Error	A failure occurred in the linear encoder.	-	Turn the power supply to the SERVOPACK OFF and ON again. If the alarm still occurs, the linear encoder may be faulty. Replace the linear encoder.	-

Continued on next page.

Continued from previous page.

Alarm Number: Alarm Name	Possible Cause	Confirmation	Correction	Reference
<b>A.b33:</b> Current Detection Error 3	A failure occurred in the current detection circuit.	–	Turn the power supply to the SERVOPACK OFF and ON again. If the alarm still occurs, the SERVOPACK may be faulty. Replace the SERVOPACK.	–
<b>A.b6A:</b> MECHATROLINK Communications ASIC Error 1	There is a fault in the SERVOPACK MECHATROLINK communications section.	–	Turn the power supply to the SERVOPACK OFF and ON again. If the alarm still occurs, the SERVOPACK may be faulty. Replace the SERVOPACK.	–
<b>A.b6b:</b> MECHATROLINK Communications ASIC Error 2	A malfunction occurred in the MECHATROLINK communications section due to noise.	–	Implement the following countermeasures against noise. <ul style="list-style-type: none"> <li>• Check the MECHATROLINK-III Communications Cable (RJ-45) and FG wiring.</li> <li>• Attach a ferrite core to the MECHATROLINK-III Communications Cable (RJ-45).</li> </ul>	–
	There is a fault in the SERVOPACK MECHATROLINK communications section.	–	Turn the power supply to the SERVOPACK OFF and ON again. If the alarm still occurs, the SERVOPACK may be faulty. Replace the SERVOPACK.	–
<b>A.bF0:</b> System Alarm 0	A failure occurred in the SERVOPACK.	–	Turn the power supply to the SERVOPACK OFF and ON again. If the alarm still occurs, the SERVOPACK may be faulty. Replace the SERVOPACK.	–
<b>A.bF1:</b> System Alarm 1	A failure occurred in the SERVOPACK.	–	Turn the power supply to the SERVOPACK OFF and ON again. If the alarm still occurs, the SERVOPACK may be faulty. Replace the SERVOPACK.	–
<b>A.bF2:</b> System Alarm 2	A failure occurred in the SERVOPACK.	–	Turn the power supply to the SERVOPACK OFF and ON again. If the alarm still occurs, the SERVOPACK may be faulty. Replace the SERVOPACK.	–
<b>A.bF3:</b> System Alarm 3	A failure occurred in the SERVOPACK.	–	Turn the power supply to the SERVOPACK OFF and ON again. If the alarm still occurs, the SERVOPACK may be faulty. Replace the SERVOPACK.	–
<b>A.bF4:</b> System Alarm 4	A failure occurred in the SERVOPACK.	–	Turn the power supply to the SERVOPACK OFF and ON again. If the alarm still occurs, the SERVOPACK may be faulty. Replace the SERVOPACK.	–

Continued on next page.

10.2 Alarm Displays

10.2.2 Troubleshooting Alarms

Continued from previous page.

Alarm Number: Alarm Name	Possible Cause	Confirmation	Correction	Reference
A.bF5: System Alarm 5	A failure occurred in the SERVOPACK.	—	Turn the power supply to the SERVOPACK OFF and ON again. If the alarm still occurs, the SERVOPACK may be faulty. Replace the SERVOPACK.	—
A.bF6: System Alarm 6	A failure occurred in the SERVOPACK.	—	Turn the power supply to the SERVOPACK OFF and ON again. If the alarm still occurs, the SERVOPACK may be faulty. Replace the SERVOPACK.	—
A.bF7: System Alarm 7	A failure occurred in the SERVOPACK.	—	Turn the power supply to the SERVOPACK OFF and ON again. If the alarm still occurs, the SERVOPACK may be faulty. Replace the SERVOPACK.	—
A.bF8: System Alarm 8	A failure occurred in the SERVOPACK.	—	Turn the power supply to the SERVOPACK OFF and ON again. If the alarm still occurs, the SERVOPACK may be faulty. Replace the SERVOPACK.	—
A.C10: Servomotor Out of Control (Detected when the servo is turned ON.)	The order of phases U, V, and W in the motor wiring is not correct.	Check the Servomotor wiring.	Make sure that the Servomotor is correctly wired.	—
	There is an error in the setting of Pn080 = n.□□X□ (Motor Phase Selection).	Check the setting of Pn080 = n.□□X□.	Set Pn080 = n.□□X□ to an appropriate value.	page 5-22
	A failure occurred in the encoder.	—	If the motor wiring is correct and the alarm still occurs after turning the power supply OFF and ON again, the Servomotor or linear encoder may be faulty. Replace the Servomotor or linear encoder.	—
	A failure occurred in the SERVOPACK.	—	Turn the power supply to the SERVOPACK OFF and ON again. If the alarm still occurs, the SERVOPACK may be faulty. Replace the SERVOPACK.	—

Continued on next page.



Continued from previous page.

Alarm Number: Alarm Name	Possible Cause	Confirmation	Correction	Reference
A.C20: Phase Detection Error	The linear encoder signal level is too low.	Check the voltage of the linear encoder signal.	Fine-tune the mounting of the scale head. Or, replace the linear encoder.	–
	The count-up direction of the linear encoder does not match the forward direction of the Moving Coil in the motor.	Check the setting of Pn080 = n.□□X□ (Motor Phase Selection). Check the installation orientation for the linear encoder and Moving Coil.	Change the setting of Pn080 = n.□□X□. Correctly reinstall the linear encoder or Moving Coil.	page 5-22
	The polarity sensor signal is being affected by noise.	–	Correct the FG wiring. Implement countermeasures against noise for the polarity sensor wiring.	–
	The setting of Pn282 (Linear Encoder Pitch) is not correct.	Check the setting of Pn282 (Linear Encoder Pitch).	Check the specifications of the linear encoder and set a correct value.	page 5-17
A.C21: Polarity Sensor Error	The polarity sensor is protruding from the Magnetic Way of the motor.	Check the polarity sensor.	Correctly reinstall the Moving Coil or Magnetic Way of the motor.	–
	The polarity sensor is not wired correctly.	Check the wiring of the polarity sensor.	Correct the wiring of the polarity sensor.	–
	The polarity sensor failed.	–	Replace the polarity sensor.	–
A.C22: Phase Information Disagreement	The SERVOPACK phase information is different from the linear encoder phase information.	–	Perform polarity detection.	page 5-27

Continued on next page.

Continued from previous page.

Alarm Number: Alarm Name	Possible Cause	Confirmation	Correction	Reference
A.C50: Polarity Detection Failure	The parameter settings are not correct.	Check the linear encoder specifications and feedback signal status.	The settings of Pn282 (Linear Encoder Pitch) and Pn080 = n.□□X□ (Motor Phase Selection) may not match the installation. Set the parameters to correct values.	page 5-17, page 5-22
	There is noise on the scale signal.	Check to make sure that the frame grounds of the Serial Converter Unit and Servomotor are connected to the FG terminal on the SERVOPACK and that the FG terminal on the SERVOPACK is connected to the frame ground on the power supply. And, confirm that the shield is properly processed on the Linear Encoder Cable. Check to see if the detection reference is repeatedly output in one direction.	Implement appropriate countermeasures against noise for the Linear Encoder Cable.	—
	An external force was applied to the Moving Coil of the motor.	—	The polarity cannot be properly detected if the detection reference is 0 and the speed feedback is not 0 because of an external force, such as cable tension, applied to the Moving Coil. Implement measures to reduce the external force so that the speed feedback goes to 0. If the external force cannot be reduced, increase the setting of Pn481 (Polarity Detection Speed Loop Gain).	—
	The linear encoder resolution is too low.	Check the linear encoder scale pitch to see if it is within 100 μm.	If the linear encoder scale pitch is 100 μm or higher, the SERVOPACK cannot detect the correct speed feedback. Use a linear encoder scale pitch with higher resolution. (We recommend a pitch of 40 μm or less.) Or, increase the setting of Pn485 (Polarity Detection Reference Speed). However, increasing the setting of Pn485 will increase the Servomotor movement range that is required for polarity detection.	—
A.C51: Overtravel Detected during Polarity Detection	The overtravel signal was detected during polarity detection.	Check the overtravel position.	Wire the overtravel signals. Execute polarity detection at a position where an overtravel signal would not be detected.	page 4-36

Continued on next page.

Continued from previous page.

Alarm Number: Alarm Name	Possible Cause	Confirmation	Correction	Reference
<b>A.C52:</b> Polarity Detection Not Completed	The servo was turned ON when using an absolute linear encoder, Pn587 was set to n.□□□0 (Do not detect polarity), and the polarity had not been detected.	–	When using an absolute linear encoder, set Pn587 to n.□□□1 (Detect polarity)	–
<b>A.C53:</b> Out of Range of Motion for Polarity Detection	The travel distance exceeded the setting of Pn48E (Polarity Detection Range) in the middle of detection.	–	Increase the setting of Pn48E (Polarity Detection Range). Or, increase the setting of Pn481 (Polarity Detection Speed Loop Gain).	–
<b>A.C54:</b> Polarity Detection Failure 2	An external force was applied to the Servomotor.	–	Increase the setting of Pn495 (Polarity Detection Confirmation Force Reference). Increase the setting of Pn498 (Polarity Detection Allowable Error Range). Increasing the allowable error will also increase the motor temperature.	–
<b>A.C80:</b> Encoder Clear Error or Multiturn Limit Setting Error	A failure occurred in the encoder.	–	Turn the power supply to the SERVOPACK OFF and ON again. If the alarm still occurs, the Servomotor or linear encoder may be faulty. Replace the Servomotor or linear encoder.	–
	A failure occurred in the SERVOPACK.	–	Turn the power supply to the SERVOPACK OFF and ON again. If the alarm still occurs, the SERVOPACK may be faulty. Replace the SERVOPACK.	–

Continued on next page.

Continued from previous page.

Alarm Number: Alarm Name	Possible Cause	Confirmation	Correction	Reference
A.C90: Encoder Commu- nications Error	There is a faulty contact in the connector or the connector is not wired correctly for the encoder.	Check the condition of the encoder connector.	Reconnect the encoder connector and check the encoder wiring.	page 4-21
	There is a cable disconnection or short-circuit in the encoder. Or, the cable impedance is outside the specified values.	Check the condition of the Encoder Cable.	Use the Encoder Cable within the specified specifications.	-
	One of the following has occurred: corrosion caused by improper temperature, humidity, or gas, a short-circuit caused by entry of water drops or cutting oil, or faulty contact in connector caused by vibration.	Check the operating environment.	Improve the operating environment, and replace the cable. If the alarm still occurs, replace the SERVOPACK.	page 3-2
	A malfunction was caused by noise.	-	Correct the wiring around the encoder by separating the Encoder Cable from the Servomotor Main Circuit Cable or by grounding the encoder.	page 4-6
	A failure occurred in the SERVOPACK.	-	Connect the Servomotor to another SERVOPACK, and turn ON the control power supply. If no alarm occurs, the SERVOPACK may be faulty. Replace the SERVOPACK.	-
A.C91: Encoder Commu- nications Posi- tion Data Acceleration Rate Error	Noise entered on the signal lines because the Encoder Cable is bent or the sheath is damaged.	Check the condition of the Encoder Cable and connectors.	Check the Encoder Cable to see if it is installed correctly.	page 4-9
	The Encoder Cable is bundled with a high-current line or installed near a high-current line.	Check the installation condition of the Encoder Cable.	Confirm that there is no surge voltage on the Encoder Cable.	-
	There is variation in the FG potential because of the influence of machines on the Servomotor side, such as a welder.	Check the installation condition of the Encoder Cable.	Properly ground the machine to separate it from the FG of the encoder.	-

Continued on next page.

Continued from previous page.

Alarm Number: Alarm Name	Possible Cause	Confirmation	Correction	Reference
A.C92: Encoder Commu- nications Timer Error	Noise entered on the signal line from the encoder.	–	Implement countermeasures against noise for the encoder wiring.	page 4-6
	Excessive vibration or shock was applied to the encoder.	Check the operating conditions.	Reduce machine vibration. Correctly install the Servomotor or linear encoder.	–
	A failure occurred in the encoder.	–	Turn the power supply to the SERVOPACK OFF and ON again. If the alarm still occurs, the Servomotor or linear encoder may be faulty. Replace the Servomotor or linear encoder.	–
	A failure occurred in the SERVOPACK.	–	Turn the power supply to the SERVOPACK OFF and ON again. If the alarm still occurs, the SERVOPACK may be faulty. Replace the SERVOPACK.	–
A.CA0: Encoder Parame- ter Error	A failure occurred in the encoder.	–	Turn the power supply to the SERVOPACK OFF and ON again. If the alarm still occurs, the Servomotor or linear encoder may be faulty. Replace the Servomotor or linear encoder.	–
	A failure occurred in the SERVOPACK.	–	Turn the power supply to the SERVOPACK OFF and ON again. If the alarm still occurs, the SERVOPACK may be faulty. Replace the SERVOPACK.	–

Continued on next page.

10.2 Alarm Displays

10.2.2 Troubleshooting Alarms

Continued from previous page.

Alarm Number: Alarm Name	Possible Cause	Confirmation	Correction	Reference
A.Cb0: Encoder Echo- back Error	The encoder is wired incorrectly or there is faulty contact.	Check the wiring of the encoder.	Make sure that the encoder is correctly wired.	page 4-21
	The specifications of the Encoder Cable are not correct and noise entered on it.	–	Use a shielded twisted-pair wire cable or a screened twisted-pair cable with conductors of at least 0.12 mm <sup>2</sup> .	–
	The Encoder Cable is too long and noise entered on it.	–	<ul style="list-style-type: none"> <li>Rotary Servomotors: The Encoder Cable wiring distance must be 50 m max.</li> <li>Linear Servomotors: The Encoder Cable wiring distance must be 20 m max.</li> </ul>	–
	There is variation in the FG potential because of the influence of machines on the Servomotor side, such as a welder.	Check the condition of the Encoder Cable and connectors.	Properly ground the machine to separate it from the FG of the encoder.	–
	Excessive vibration or shock was applied to the encoder.	Check the operating conditions.	Reduce machine vibration. Correctly install the Servomotor or linear encoder.	–
	A failure occurred in the encoder.	–	Turn the power supply to the SERVOPACK OFF and ON again. If the alarm still occurs, the Servomotor or linear encoder may be faulty. Replace the Servomotor or linear encoder.	–
	A failure occurred in the SERVOPACK.	–	Turn the power supply to the SERVOPACK OFF and ON again. If the alarm still occurs, the SERVOPACK may be faulty. Replace the SERVOPACK.	–
A.CC0: Multiturn Limit Disagreement	When using a Direct Drive Servomotor, the setting of Pn205 (Multiturn Limit Setting) does not agree with the encoder.	Check the setting of Pn205.	Correct the setting of Pn205 (0 to 65,535).	page 6-30
	The multiturn limit of the encoder is different from that of the SERVOPACK. Or, the multiturn limit of the SERVOPACK has been changed.	Check the setting of Pn205 in the SERVOPACK.	Change the setting if the alarm occurs.	page 6-30
	A failure occurred in the SERVOPACK.	–	Turn the power supply to the SERVOPACK OFF and ON again. If the alarm still occurs, the SERVOPACK may be faulty. Replace the SERVOPACK.	–

Continued on next page.

Continued from previous page.

Alarm Number: Alarm Name	Possible Cause	Confirmation	Correction	Reference
<b>A.d00:</b> Position Deviation Overflow (The setting of Pn520 (Excessive Position Deviation Alarm Level) was exceeded by the position deviation while the servo was ON.)	The Servomotor U, V, and W wiring is not correct.	Check the wiring of the Servomotor's Main Circuit Cables.	Make sure that there are no faulty contacts in the wiring for the Servomotor and encoder.	–
	The position command speed is too fast.	Reduce the position command speed and try operating the SERVOPACK.	Reduce the position reference speed or the reference acceleration rate, or reconsider the electronic gear ratio.	page 5-44
	The acceleration of the position reference is too high.	Reduce the reference acceleration and try operating the SERVOPACK.	Reduce the acceleration of the position reference using a MECHATROLINK command. Or, smooth the position reference acceleration by selecting the position reference filter (ACCFIL) using a MECHATROLINK command.	–
	The setting of Pn520 (Excessive Position Deviation Alarm Level) is too low for the operating conditions.	Check Pn520 (Excessive Position Deviation Alarm Level) to see if it is set to an appropriate value.	Optimize the setting of Pn520.	page 8-8
	A failure occurred in the SERVOPACK.	–	Turn the power supply to the SERVOPACK OFF and ON again. If the alarm still occurs, the SERVOPACK may be faulty. Replace the SERVOPACK.	–
<b>A.d01:</b> Position Deviation Overflow Alarm at Servo ON	The servo was turned ON after the position deviation exceeded the setting of Pn526 (Excessive Position Deviation Alarm Level at Servo ON) while the servo was OFF.	Check the position deviation while the servo is OFF.	Optimize the setting of Pn526 (Excessive Position Deviation Alarm Level at Servo ON).	
<b>A.d02:</b> Position Deviation Overflow Alarm for Speed Limit at Servo ON	If position deviation remains in the deviation counter, the setting of Pn529 or Pn584 (Speed Limit Level at Servo ON) limits the speed when the servo is turned ON. This alarm occurs if a position reference is input and the setting of Pn520 (Excessive Position Deviation Alarm Level) is exceeded.	–	Optimize the setting of Pn520 (Excessive Position Deviation Alarm Level). Or, adjust the setting of Pn529 or Pn584 (Speed Limit Level at Servo ON).	page 8-8
<b>A.d30:</b> Position Data Overflow	The position data exceeded $\pm 1,879,048,192$ .	Check the input reference pulse counter.	Reconsider the operating specifications.	–

Continued on next page.

10.2 Alarm Displays

10.2.2 Troubleshooting Alarms

Continued from previous page.

Alarm Number: Alarm Name	Possible Cause	Confirmation	Correction	Reference
A.E02: MECHATROLINK Internal Synchronization Error 1	The MECHATROLINK transmission cycle fluctuated.	–	Remove the cause of transmission cycle fluctuation at the host controller.	–
	A failure occurred in the SERVOPACK.	–	Turn the power supply to the SERVOPACK OFF and ON again. If the alarm still occurs, the SERVOPACK may be faulty. Replace the SERVOPACK.	–
A.E40: MECHATROLINK Transmission Cycle Setting Error	The setting of MECHATROLINK transmission cycle is outside of the specified range.	Check the setting of the MECHATROLINK transmission cycle.	Set the MECHATROLINK transmission cycle to an appropriate value.	–
A.E41: MECHATROLINK Communications Data Size Setting Error	The number of transmission bytes set on DIP switch S3 is not correct.	Check the MECHATROLINK communications data size of the host controller.	Reset DIP switch S3 to change the number of transmission bytes to an appropriate value.	page 5-11
A.E42: MECHATROLINK Station Address Setting Error	The station address is outside of the setting range.	Check rotary switches S1 and S2 to see if the station address is between 03 and EF.	Check the setting of the station address of the host controller, and reset rotary switches S1 and S2 to change the address to an appropriate value between 03 and EF.	page 5-11
	Two or more stations on the communications network have the same address.	Check to see if two or more stations on the communications network have the same address.	Check the setting of the station address of the host controller, and reset rotary switches S1 and S2 to change the address to an appropriate value between 03 and EF.	
A.E50*5: MECHATROLINK Synchronization Error	The WDT data in the host controller was not updated normally.	Check to see if the WDT data is being updated at the host controller.	Correctly update the WDT data at the host controller.	–
	A failure occurred in the SERVOPACK.	–	Turn the power supply to the SERVOPACK OFF and ON again. If the alarm still occurs, the SERVOPACK may be faulty. Replace the SERVOPACK.	–
A.E51: MECHATROLINK Synchronization Failed	The WDT data at the host controller was not updated correctly at the start of synchronous communications, so synchronous communications could not be started.	Check to see if the WDT data is being updated in the host controller.	Correctly update the WDT data at the host controller.	–
	A failure occurred in the SERVOPACK.	–	Turn the power supply to the SERVOPACK OFF and ON again. If the alarm still occurs, the SERVOPACK may be faulty. Replace the SERVOPACK.	–

Continued on next page.



Continued from previous page.

Alarm Number: Alarm Name	Possible Cause	Confirmation	Correction	Reference
A.E60*5: Reception Error in MECHATROLINK Communications	MECHATROLINK wiring is not correct.	Check the MECHATROLINK wiring.	Correct the MECHATROLINK-III Communications Cable (RJ-45) wiring. Correctly connect the terminator.	-
	A MECHATROLINK data reception error occurred due to noise.	-	Implement countermeasures against noise. (Check the MECHATROLINK-III Communications Cable (RJ-45) and FG wiring, and implement measures such as attaching a ferrite core to the MECHATROLINK-III Communications Cable (RJ-45).)	-
	A failure occurred in the SERVOPACK.	-	Turn the power supply to the SERVOPACK OFF and ON again. If the alarm still occurs, the SERVOPACK may be faulty. Replace the SERVOPACK.	-
A.E61: Synchronization Interval Error in MECHATROLINK Transmission Cycle	The MECHATROLINK transmission cycle fluctuated.	Check the setting of the MECHATROLINK transmission cycle.	Remove the cause of transmission cycle fluctuation at the host controller.	-
	A failure occurred in the SERVOPACK.	-	Turn the power supply to the SERVOPACK OFF and ON again. If the alarm still occurs, the SERVOPACK may be faulty. Replace the SERVOPACK.	-
A.E63: MECHATROLINK Synchronization Frame Not Received	MECHATROLINK wiring is not correct.	Check the Servomotor wiring.	Correct the MECHATROLINK-III Communications Cable (RJ-45) wiring.	-
	A MECHATROLINK data reception error occurred due to noise.	-	Implement countermeasures against noise. (Check the MECHATROLINK-III Communications Cable (RJ-45) and FG wiring, and implement measures such as attaching a ferrite core to the MECHATROLINK-III Communications Cable (RJ-45).)	-
	A failure occurred in the SERVOPACK.	-	Turn the power supply to the SERVOPACK OFF and ON again. If the alarm still occurs, the SERVOPACK may be faulty. Replace the SERVOPACK.	-
A.Ed1: Command Execution Timeout	A timeout error occurred for a MECHATROLINK command.	Check the motor status when the command is executed.	Execute the SV_ON or SENS_ON command only when the motor is not operating.	-
		Check the encoder status when the command is executed.	Execute the SENS_ON command only when an encoder is connected.	-

Continued on next page.

10.2 Alarm Displays

10.2.2 Troubleshooting Alarms

Continued from previous page.

Alarm Number: Alarm Name	Possible Cause	Confirmation	Correction	Reference
<b>A.F10:</b> Power Supply Line Open Phase (The voltage was low for more than one second for phase R, S, or T when the main power supply was ON.)	The three-phase power supply wiring is not correct.	Check the power supply wiring.	Make sure that the power supply is correctly wired.	page 4-11
	The three-phase power supply is unbalanced.	Measure the voltage for each phase of the three-phase power supply.	Balance the power supply by changing phases.	-
	A single-phase power supply was input without specifying a single-phase AC power supply input (Pn00B = n.□1□□).	Check the power supply and the parameter setting.	Match the parameter setting to the power supply.	page 4-11
	A failure occurred in the SERVOPACK.	-	Turn the power supply to the SERVOPACK OFF and ON again. If the alarm still occurs, the SERVOPACK may be faulty. Replace the SERVOPACK.	-
<b>FL-1*5:</b> System Alarm	A failure occurred in the SERVOPACK.	-	Turn the power supply to the SERVOPACK OFF and ON again. If the alarm still occurs, the SERVOPACK may be faulty. Replace the SERVOPACK.	-
<b>FL-2*5:</b> System Alarm				
<b>FL-3*5:</b> System Alarm				
<b>FL-4*5:</b> System Alarm				
<b>FL-5*5:</b> System Alarm				
<b>FL-6*5:</b> System Alarm				
<b>CPF00:</b> Digital Operator Communications Error 1	There is a faulty contact between the Digital Operator and the SERVOPACK.	Check the connector contact.	Disconnect the connector and insert it again. Or, replace the cable.	-
	A malfunction was caused by noise.	-	Keep the Digital Operator or the cable away from sources of noise.	-
<b>CPF01:</b> Digital Operator Communications Error 2	A failure occurred in the Digital Operator.	-	Disconnect the Digital Operator and then connect it again. If the alarm still occurs, the Digital Operator may be faulty. Replace the Digital Operator.	-
	A failure occurred in the SERVOPACK.	-	Turn the power supply to the SERVOPACK OFF and ON again. If the alarm still occurs, the SERVOPACK may be faulty. Replace the SERVOPACK.	-

## \*1. Detection Conditions

## • Rotary Servomotor

If either of the following conditions is detected, an alarm will occur.

$$\bullet \text{ Pn533 [min}^{-1}\text{]} \times \frac{\text{Encoder resolution}}{6 \times 10^5} \leq \frac{\text{Pn20E}}{\text{Pn210}}$$

$$\bullet \text{ Maximum motor speed [min}^{-1}\text{]} \times \frac{\text{Encoder resolution}}{\text{Approx. } 3.66 \times 10^{12}} \geq \frac{\text{Pn20E}}{\text{Pn210}}$$

## • Linear Servomotor

If either of the following conditions is detected, an alarm will occur.

$$\bullet \frac{\text{Pn585 [mm/s]}}{\text{Linear encoder pitch [\mu m]}} \times \frac{\text{Resolution of Serial Converter Unit}}{10} \leq \frac{\text{Pn20E}}{\text{Pn210}}$$

$$\bullet \frac{\text{Pn385 [100 mm/s]}}{\text{Linear encoder pitch [\mu m]}} \times \frac{\text{Resolution of Serial Converter Unit}}{\text{Approx. } 6.10 \times 10^5} \geq \frac{\text{Pn20E}}{\text{Pn210}}$$

## \*2. Detection Conditions

## • Rotary Servomotor

If either of the following conditions is detected, an alarm will occur.

$$\bullet \text{ Rated motor speed [min}^{-1}\text{]} \times 1/3 \times \frac{\text{Encoder resolution}}{6 \times 10^5} \leq \frac{\text{Pn20E}}{\text{Pn210}}$$

$$\bullet \text{ Maximum motor speed [min}^{-1}\text{]} \times \frac{\text{Encoder resolution}}{\text{Approx. } 3.66 \times 10^{12}} \geq \frac{\text{Pn20E}}{\text{Pn210}}$$

## • Linear Servomotor

If either of the following conditions is detected, an alarm will occur.

$$\bullet \frac{\text{Rated motor speed [mm/s]} \times 1/3}{\text{Linear encoder pitch [\mu m]}} \times \frac{\text{Resolution of Serial Converter Unit}}{10} \leq \frac{\text{Pn20E}}{\text{Pn210}}$$

$$\bullet \frac{\text{Pn385 [100 mm/s]}}{\text{Linear encoder pitch [\mu m]}} \times \frac{\text{Resolution of Serial Converter Unit}}{\text{Approx. } 6.10 \times 10^5} \geq \frac{\text{Pn20E}}{\text{Pn210}}$$

## \*3. Refer to the following manual for details.

 **Σ-7-Series Peripheral Device Selection Manual (Manual No.: SIEP S800001 32)**

\*4. The SERVOPACK will fail if the External Regenerative Resistor or Regenerative Resistor Unit is connected while the jumper is connected between the B2 and B3 terminals.

\*5. These alarms are not stored in the alarm history. They are only displayed on the panel display.

---

## 10.2.3 Resetting Alarms

---

If there is an ALM (Servo Alarm) signal, use one of the following methods to reset the alarm after eliminating the cause of the alarm.



Be sure to eliminate the cause of an alarm before you reset the alarm.  
If you reset the alarm and continue operation without eliminating the cause of the alarm, it may result in damage to the equipment or fire.

### Resetting Alarms by Sending the ALM\_CLR (Clear Warning or Alarm) Command

Refer to the following manual for details.

📖  $\Sigma$ -7-Series MECHATROLINK-III Communications Standard Servo Profile Command Manual (Manual No.: SIEP S800001 31)

### Resetting Alarms Using the Digital Operator

Press the **ALARM RESET** Key on the Digital Operator. Refer to the following manual for details on resetting alarms.

📖  $\Sigma$ -7-Series Digital Operator Operating Manual (Manual No.: SIEP S800001 33)

## 10.2.4 Displaying the Alarm History

The alarm history displays up to the last ten alarms that have occurred in the SERVOPACK. Alarms are displayed for the selected axis.



Note: The following alarms are not displayed in the alarm history: A.E50 (MECHATROLINK Synchronization Error), A.E60 (Reception Error in MECHATROLINK Communications), and FL-1 to FL-6.

### Preparations

No preparations are required.

### Applicable Tools

The following table lists the tools that you can use to display the alarm history and the applicable tool functions.

Tool	Function	Reference
Digital Operator	Fn000	 $\Sigma$ -7-Series Digital Operator Operating Manual (Manual No.: SIEP S80001 33)
SigmaWin+	<b>Alarm – Display Alarm</b>	 <i>Operating Procedure</i> on page 10-39

### Operating Procedure

Use the following procedure to display the alarm history.

1. Click the  Servo Drive Button in the workspace of the Main Window of the SigmaWin+.
2. Select **Display Alarm** in the Menu Dialog Box.  
The Alarm Display Dialog Box will be displayed.
3. Click the **Alarm History** Tab.  
The following display will appear and you can check the alarms that occurred in the past.

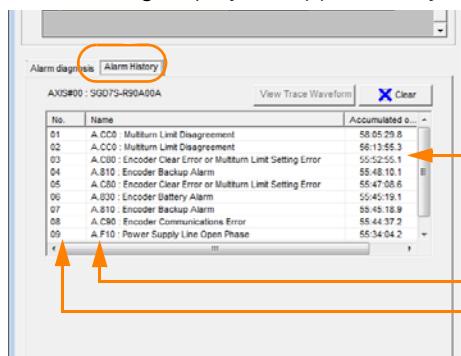

Accumulated operation time  
Total operation time to the point at which the alarm occurred is displayed in increments of 100 ms from when the control power supply and main circuit power supply turned ON.  
For 24-hour, 365-day operation, measurements are possible for approximately 13 years.

Alarm number: Alarm name  
Alarms in order of occurrence  
(Older alarms have higher numbers.)

#### Information

1. If the same alarm occurs consecutively within one hour, it is not saved in the alarm history. If it occurs after an hour or more, it is saved.
2. You can clear the alarm history by clicking the **Clear** Button. The alarm history is not cleared when alarms are reset or when the SERVOPACK main circuit power is turned OFF.

This concludes the procedure to display the alarm history.

## 10.2.5 Clearing the Alarm History

You can clear the alarm history that is recorded in the SERVOPACK. You can specify the axis for which to delete the history.

The alarm history is not cleared when alarms are reset or when the SERVOPACK main circuit power is turned OFF. You must perform the following procedure.

### Preparations

Always check the following before you clear the alarm history.

- The parameters must not be write prohibited.

### Applicable Tools

The following table lists the tools that you can use to clear the alarm history and the applicable tool functions.

Tool	Function	Reference
Digital Operator	Fn006	Σ-7-Series Digital Operator Operating Manual (Manual No.: SIEP S800001 33)
SigmaWin+	<b>Alarm – Display Alarm</b>	Operating Procedure on page 10-40

### Operating Procedure

Use the following procedure to reset the alarm history.

1. Click the  Servo Drive Button in the workspace of the Main Window of the SigmaWin+.
2. Select **Display Alarm** in the Menu Dialog Box.  
The Alarm Display Dialog Box will be displayed.
3. Click the **Alarm History** Tab.
4. Click the **Clear** Button.  
The alarm history will be cleared.

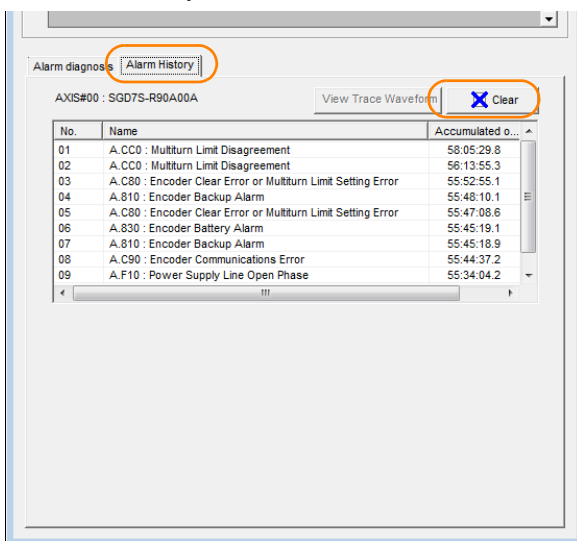

This concludes the procedure to reset the alarm history.

## 10.2.6 Resetting Motor Type Alarms

The SERVOPACK automatically determines the type of Servomotor that is connected to it. If the type of Servomotor that is connected is changed, an A.070 alarm (Motor Type Change Detected) will occur the next time the SERVOPACK is started. If an A.070 alarm occurs, you must set the parameters to match the new type of Servomotor.

An A.070 alarm is reset by executing the Reset Motor Type Alarm utility function.

- Information**
1. This utility function is the only way to reset an A.070 alarm (Motor Type Change Detected). The errors are not reset when you reset alarms or turn OFF the power supply to the SERVOPACK.
  2. If an A.070 alarm occurs, first set the parameters according to the newly connected Servomotor type and then execute the Reset Motor Type Alarm utility function.



### Preparations

Always check the following before you clear a motor type alarm.

- The parameters must not be write prohibited.

### Applicable Tools

The following table lists the tools that you can use to clear the motor type alarm and the applicable tool functions.

Tool	Function	Reference
Digital Operator	Fn021	 $\Sigma$ -7-Series Digital Operator Operating Manual (Manual No.: SIEP S800001 33)
SigmaWin+	<b>Alarm – Reset Motor Type Alarm</b>	 Operating Procedure on page 10-41

### Operating Procedure

Use the following procedure to reset Motor Type alarm.

1. Click the  Servo Drive Button in the workspace of the Main Window of the SigmaWin+.
2. Select **Reset Motor Type Alarm** in the Menu Dialog Box.  
The Reset Motor Type Alarm Dialog Box will be displayed.
3. Click the **Clear Button**.  
The alarm will be cleared.

This concludes the procedure to reset Motor Type alarms.

## 10.3 Warning Displays

If a warning occurs in the SERVOPACK, a warning number will be displayed on the panel display. Warnings are displayed to warn you before an alarm occurs.

This section provides a list of warnings and the causes of and corrections for warnings.

### 10.3.1 List of Warnings

The warning table gives the warning name and warning meaning in order of the warning numbers.

If “All Axes” is given below the warning number, the warning applies to both axes. If a warning occurs for one axis, the same warning status will occur for the other axis.

Warning Number	Warning Name	Meaning	Resetting
A.900	Position Deviation Overflow	The position deviation exceeded the percentage set with the following formula: (Pn520 × Pn51E/100)	Required.
A.901	Position Deviation Overflow Alarm at Servo ON	The position deviation when the servo was turned ON exceeded the percentage set with the following formula: (Pn526 × Pn528/100)	Required.
A.910	Overload	This warning occurs before an overload alarm (A.710 or A.720) occurs. If the warning is ignored and operation is continued, an alarm may occur.	Required.
A.911	Vibration	Abnormal vibration was detected during motor operation. The detection level is the same as A.520. Set whether to output an alarm or a warning by setting Pn310 (Vibration Detection Switch).	Required.
A.912 All Axes	Internal Temperature Warning 1 (Control Board Temperature Error)	The surrounding temperature of the control PCB is abnormal.	Required.
A.913 All Axes	Internal Temperature Warning 2 (Power Board Temperature Error)	The surrounding temperature of the power PCB is abnormal.	Required.
A.920 All Axes	Regenerative Overload	This warning occurs before an A.320 alarm (Regenerative Overload) occurs. If the warning is ignored and operation is continued, an alarm may occur.	Required.
A.921	Dynamic Brake Overload	This warning occurs before an A.731 alarm (Dynamic Brake Overload) occurs. If the warning is ignored and operation is continued, an alarm may occur.	Required.
A.923 All Axes	SERVOPACK Built-in Fan Stopped	The fan inside the SERVOPACK stopped.	Required.
A.930	Absolute Encoder Battery Error	This warning occurs when the voltage of absolute encoder's battery is low.	Required.
A.93B	Overheat Warning	The input voltage (temperature) for the overheat protection input (TH) signal exceeded the setting of Pn61C (Overheat Warning Level).	Required.
A.942	Speed Ripple Compensation Information Disagreement	The speed ripple compensation information stored in the encoder does not agree with the speed ripple compensation information stored in the SERVOPACK.	Required.
A.94A	Data Setting Warning 1 (Parameter Number Error)	There is an error in the parameter number for a Data Setting Warning 1 (Parameter Number) command.	Automatically reset.*

Continued on next page.



Continued from previous page.

Warning Number	Warning Name	Meaning	Resetting
A.94b	Data Setting Warning 2 (Out of Range)	The command data is out of range.	Automatically reset.*
A.94C	Data Setting Warning 3 (Calculation Error)	A calculation error was detected.	Automatically reset.*
A.94d	Data Setting Warning 4 (Parameter Size)	The data sizes do not match.	Automatically reset.*
A.94E	Data Setting Warning 5 (Latch Mode Error)	A latch mode error was detected.	Required.
A.95A	Command Warning 1 (Unsatisfied Command Conditions)	A command was sent when the conditions for sending a command were not satisfied.	Automatically reset.*
A.95b	Command Warning 2 (Unsupported Command)	An unsupported command was sent.	Automatically reset.*
A.95d	Command Warning 4 (Command Interference)	There was command interference, particularly latch command interference.	Automatically reset.*
A.95E	Command Warning 5 (Subcommand Not Possible)	The subcommand and main command interfere with each other.	Automatically reset.*
A.95F	Command Warning 6 (Undefined Command)	An undefined command was sent.	Automatically reset.*
A.960	MECHATROLINK Communications Warning	A communications error occurred during MECHATROLINK communications.	Required.
A.971 All Axes	Undervoltage	This warning occurs before an A.410 alarm (Undervoltage) occurs. If the warning is ignored and operation is continued, an alarm may occur.	Required.
A.97A	Command Warning 7 (Phase Error)	A command that cannot be executed in the current phase was sent.	Automatically reset.*
A.97b	Data Clamp Out of Range	The set command data was clamped to the minimum or maximum value of the allowable setting range.	Automatically reset.*
A.9A0	Overtravel	Overtravel was detected while the servo was ON.	Required.
A.9b0 All Axes	Preventative Maintenance Warning	One of the consumable parts has reached the end of its service life.	Required.

\* If using the commands for the MECHATROLINK-III standard servo profile, the warning will automatically be cleared after the correct command is received. If you use MECHATROLINK-II-compatible profile commands, send an ALM\_CLR (Clear Warning or Alarm) command to clear the warning.

Note: Use Pn008 = n.□X□□ (Warning Detection Selection) to control warning detection.

However, the following warnings are not affected by the setting of Pn008 = n.□X□□ and other parameter settings are required in addition to Pn008 = n.□X□□.

Warning	Parameters That Must Be Set to Select Warning Detection	Reference
A.911	Pn310 = n.□□□X (Vibration Detection Setting)	page 6-37
A.923	– (Not affected by the setting of Pn008 = n.□X□□.)	–
A.930	Pn008 = n.□□□X (Low Battery Voltage Alarm/Warning Selection)	page 10-3
A.942	Pn423 = n.□□□X (Speed Ripple Compensation Information Disagreement Warning Detection Selection)	page 8-62
A.94A to A.960 and A.97A to A.97b	Pn800=n.□□□X (Warning Check Masks)	page 11-3
A.971	Pn008 = n.□□□X (Function Selection for Undervoltage) (Not affected by the setting of Pn008 = n.□X□□.)	page 6-18
A.9A0	Pn00D = n.X□□□ (Overtravel Warning Detection Selection) (Not affected by the setting of Pn008 = n.□X□□.)	page 5-31
A.9b0	Pn00F = n.□□□X (Preventative Maintenance Selection)	page 9-16

## 10.3.2 Troubleshooting Warnings

The causes of and corrections for the warnings are given in the following table. Contact your Yaskawa representative if you cannot solve a problem with the correction given in the table.

Warning Number: Warning Name	Possible Cause	Confirmation	Correction	Reference
A.900: Position Deviation Overflow	The Servomotor U, V, and W wiring is not correct.	Check the wiring of the Servomotor's Main Circuit Cables.	Make sure that there are no faulty connections in the wiring for the Servomotor and encoder.	-
	A SERVOPACK gain is too low.	Check the SERVO-PACK gains.	Increase the servo gain, e.g., by using autotuning without a host reference.	page 8-24
	The acceleration of the position reference is too high.	Reduce the reference acceleration and try operating the SERVO-PACK.	Reduce the acceleration of the position reference using a MECHATROLINK command. Or, smooth the position reference acceleration by selecting the position reference filter (ACCFIL) using a MECHATROLINK command.	-
	The excessive position deviation alarm level (Pn520 × Pn51E/100) is too low for the operating conditions.	Check excessive position deviation alarm level (Pn520 × Pn51E/100) to see if it is set to an appropriate value.	Optimize the settings of Pn520 and Pn51E.	page 8-8
	A failure occurred in the SERVO-PACK.	-	Turn the power supply to the SERVOPACK OFF and ON again. If the alarm still occurs, the SERVOPACK may be faulty. Replace the SERVOPACK.	-
A.901: Position Deviation Overflow Alarm at Servo ON	The position deviation when the servo was turned ON exceeded the percentage set with the following formula: (Pn526 × Pn528/100)	-	Optimize the setting of Pn528 (Excessive Position Error Warning Level at Servo ON).	-

Continued on next page.

Continued from previous page.

Warning Number: Warning Name	Possible Cause	Confirmation	Correction	Reference
A.910: Overload (warning before an A.710 or A.720 alarm occurs)	The wiring is not correct or there is a faulty connection in the motor or encoder wiring.	Check the wiring.	Make sure that the Servomotor and encoder are correctly wired.	-
	Operation was performed that exceeded the overload protection characteristics.	Check the motor overload characteristics and Run command.	Reconsider the load and operating conditions. Or, increase the motor capacity.	-
	An excessive load was applied during operation because the Servomotor was not driven because of mechanical problems.	Check the operation reference and motor speed.	Remove the mechanical problem.	-
	The overload warning level (Pn52B) is not suitable.	Check that the overload warning level (Pn52B) is suitable.	Set a suitable overload warning level (Pn52B).	page 5-41
	A failure occurred in the SERVOPACK.	-	The SERVOPACK may be faulty. Replace the SERVOPACK.	-
A.911: Vibration	Abnormal vibration was detected during motor operation.	Check for abnormal motor noise, and check the speed and torque waveforms during operation.	Reduce the motor speed. Or, reduce the servo gain with custom tuning.	page 8-43
	The setting of Pn103 (Moment of Inertia Ratio) is greater than the actual moment of inertia or was greatly changed.	Check the moment of inertia ratio or mass ratio.	Set Pn103 (Moment of Inertia Ratio) to an appropriate value.	page 8-16
	The vibration detection level (Pn312 or Pn384) is not suitable.	Check that the vibration detection level (Pn312 or Pn384) is suitable.	Set a suitable vibration detection level (Pn312 or Pn384).	page 6-37

Continued on next page.

10.3 Warning Displays

10.3.2 Troubleshooting Warnings

Continued from previous page.

Warning Number: Warning Name	Possible Cause	Confirmation	Correction	Reference
<b>A.912:</b> Internal Temperature Warning 1 (Control Board Temperature Error)	The surrounding temperature is too high.	Check the surrounding temperature using a thermometer. Or, check the operating status with the SERVOPACK installation environment monitor.	Decrease the surrounding temperature by improving the SERVOPACK installation conditions.	page 3-6
	An overload alarm was reset by turning OFF the power supply too many times.	Check the alarm display to see if there is an overload alarm.	Change the method for resetting the alarm.	-
	There was an excessive load or operation was performed that exceeded the regenerative processing capacity.	Use the accumulated load ratio to check the load during operation, and use the regenerative load ratio to check the regenerative processing capacity.	Reconsider the load and operating conditions.	-
	The SERVOPACK installation orientation is not correct or there is insufficient space around the SERVOPACK.	Check the SERVOPACK installation conditions.	Install the SERVOPACK according to specifications.	page 3-3, page 3-5
	A failure occurred in the SERVOPACK.	-	The SERVOPACK may be faulty. Replace the SERVOPACK.	-
<b>A.913:</b> Internal Temperature Warning 2 (Power Board Temperature Error)	The surrounding temperature is too high.	Check the surrounding temperature using a thermometer. Or, check the operating status with the SERVOPACK installation environment monitor.	Decrease the surrounding temperature by improving the SERVOPACK installation conditions.	page 3-6
	An overload alarm was reset by turning OFF the power supply too many times.	Check the alarm display to see if there is an overload alarm.	Change the method for resetting the alarm.	-
	There was an excessive load or operation was performed that exceeded the regenerative processing capacity.	Use the accumulated load ratio to check the load during operation, and use the regenerative load ratio to check the regenerative processing capacity.	Reconsider the load and operating conditions.	-
	The SERVOPACK installation orientation is not correct or there is insufficient space around the SERVOPACK.	Check the SERVOPACK installation conditions.	Install the SERVOPACK according to specifications.	page 3-3, page 3-5
	A failure occurred in the SERVOPACK.	-	The SERVOPACK may be faulty. Replace the SERVOPACK.	-

Continued on next page.

Continued from previous page.

Warning Number: Warning Name	Possible Cause	Confirmation	Correction	Reference
A.920: Regenerative Overload (warning before an A.320 alarm occurs)	The power supply voltage exceeded the specified range.	Measure the power supply voltage.	Set the power supply voltage within the specified range.	–
	There is insufficient external regenerative resistance, regenerative resistor capacity, or SERVOPACK capacity, or there has been a continuous regeneration state.	Check the operating conditions or the capacity.	Change the regenerative resistance value, regenerative resistance capacity, or SERVOPACK capacity. Reconsider the operating conditions.	–
	There was a continuous regeneration state because a negative load was continuously applied.	Check the load applied to the Servomotor during operation.	Reconsider the system including the servo, machine, and operating conditions.	–
A.921: Dynamic Brake Overload (warning before an A.731 alarm occurs)	The Servomotor was rotated by an external force.	Check the operation status.	Implement measures to ensure that the motor will not be rotated by an external force.	–
	When the Servomotor was stopped with the dynamic brake, the rotational or linear kinetic energy exceeded the capacity of the dynamic brake resistor.	Check the power consumed by the DB resistor to see how frequently the DB is being used.	Reconsider the following: <ul style="list-style-type: none"> <li>• Reduce the Servomotor command speed.</li> <li>• Decrease the moment of inertia or mass.</li> <li>• Reduce the frequency of stopping with the dynamic brake.</li> </ul>	–
	A failure occurred in the SERVOPACK.	–	The SERVOPACK may be faulty. Replace the SERVOPACK.	–
A.923: SERVOPACK Built-in Fan Stopped	The fan inside the SERVOPACK stopped.	Check for foreign matter inside the SERVOPACK.	Remove foreign matter from the SERVOPACK. If the alarm still occurs, the SERVOPACK may be faulty. Replace the SERVOPACK.	–
A.930: Absolute Encoder Battery Error (The absolute encoder battery voltage was lower than the specified level.) (Detected only when an absolute encoder is connected.)	The battery connection is faulty or a battery is not connected.	Check the battery connection.	Correct the battery connection.	page 4-22
	The battery voltage is lower than the specified value (2.7 V).	Measure the battery voltage.	Replace the battery.	page 10-3
	A failure occurred in the SERVOPACK.	–	The SERVOPACK may be faulty. Replace the SERVOPACK.	–

Continued on next page.

10.3 Warning Displays

10.3.2 Troubleshooting Warnings

Continued from previous page.

Warning Number: Warning Name	Possible Cause	Confirmation	Correction	Reference
A.93B: Overheat Warning	The surrounding temperature is too high.	Check the surrounding temperature using a thermometer.	Lower the surrounding temperature by improving the installation conditions of the Linear Servomotor or the machine.	-
	Operation was performed under an excessive load.	Use the accumulated load ratio to check the load during operation.	Reconsider the load and operating conditions.	-
	A failure occurred in the SERVOPACK.	-	The SERVOPACK may be faulty. Replace the SERVOPACK.	-
	The temperature detection circuit in the Linear Servomotor is faulty or the sensor attached to the machine is faulty.	-	The temperature detection circuit in the Linear Servomotor may be faulty or the sensor attached to the machine may be faulty. Replace the Linear Servomotor or repair the sensor attached to the machine.	-
A.942: Speed Ripple Compensation Information Disagreement	The speed ripple compensation information stored in the encoder does not agree with the speed ripple compensation information stored in the SERVOPACK.	-	Reset the speed ripple compensation value on the SigmaWin+.	page 8-62
		-	Set Pn423 to n.□□1□ (Do not detect A.942 alarms). However, changing the setting may increase the speed ripple.	page 8-62
		-	Set Pn423 to n.□□□0 (Disable torque ripple compensation). However, changing the setting may increase the speed ripple.	page 8-62
A.94A: Data Setting Warning 1 (Parameter Number Error)	An invalid parameter number was used.	Check the command that caused the warning.	Use the correct parameter number.	page 10-51
A.94b: Data Setting Warning 2 (Out of Range)	The set command data was clamped to the minimum or maximum value of the setting range.	Check the command that caused the warning.	Set the parameter within the setting range.	page 10-51
A.94C: Data Setting Warning 3 (Calculation Error)	The calculation result of the setting is not correct.	Check the command that caused the warning.	Set the parameter within the setting range.	page 10-51
A.94d: Data Setting Warning 4 (Parameter Size)	The parameter size set in the command is not correct.	Check the command that caused the warning.	Set the correct parameter size.	page 10-51
A.94E: Data Setting Warning 5 (Latch Mode Error)	A latch mode error was detected.	Check the command that caused the warning.	Change the setting of Pn850 or the LT_MOD data for the LTMOD_ON command sent by the host controller to an appropriate value. (The applies when using the MECHATROLINK-II-compatible profile.)	page 10-51

Continued on next page.

Continued from previous page.

Warning Number: Warning Name	Possible Cause	Confirmation	Correction	Reference
<b>A.95A:</b> Command Warning 1 (Unsatisfied Command Conditions)	The command conditions are not satisfied.	Check the command that caused the warning.	Send the command after the command conditions are satisfied.	page 10-51
<b>A.95b:</b> Command Warning 2 (Unsupported Command)	An unsupported command was received.	Check the command that caused the warning.	Do not send unsupported commands.	page 10-51
<b>A.95d:</b> Command Warning 4 (Command Interference)	The command sending conditions for latch-related commands was not satisfied.	Check the command that caused the warning.	Send the command after the command conditions are satisfied.	page 10-51
<b>A.95E:</b> Command Warning 5 (Subcommand Not Possible)	The command sending conditions for subcommands was not satisfied.	Check the command that caused the warning.	Send the command after the conditions are satisfied.	page 10-51
<b>A.95F:</b> Command Warning 6 (Undefined Command)	An undefined command was sent.	Check the command that caused the warning.	Do not send undefined commands.	page 10-51
<b>A.960:</b> MECHATROLINK Communications Warning	The MECHATROLINK-III Communications Cable (RJ-45) is not wired correctly.	Check the wiring conditions.	Correct the MECHATROLINK-III Communications Cable (RJ-45) wiring.	page 4-40
	A MECHATROLINK data reception error occurred due to noise.	Confirm the installation conditions.	Implement the following countermeasures against noise. <ul style="list-style-type: none"> <li>• Check the MECHATROLINK-III Communications Cable (RJ-45) and FG wiring and implement countermeasures to prevent noise from entering.</li> <li>• Attach a ferrite core to the MECHATROLINK-III Communications Cable (RJ-45).</li> </ul>	–
	A failure occurred in the SERVOPACK.	–	The SERVOPACK may be faulty. Replace the SERVOPACK.	–
<b>A.971:</b> Undervoltage	For a 200-V SERVOPACK, the AC power supply voltage dropped below 140 V.	Measure the power supply voltage.	Set the power supply voltage within the specified range.	–
	The power supply voltage dropped during operation.	Measure the power supply voltage.	Increase the power supply capacity.	–
	A momentary power interruption occurred.	Measure the power supply voltage.	If you have changed the setting of Pn509 (Momentary Power Interruption Hold Time), decrease the setting.	page 6-17
	The SERVOPACK fuse is blown out.	–	Replace the SERVOPACK and connect a reactor.	page 4-20
	A failure occurred in the SERVOPACK.	–	The SERVOPACK may be faulty. Replace the SERVOPACK.	–

Continued on next page.

10.3 Warning Displays

10.3.2 Troubleshooting Warnings

Continued from previous page.

Warning Number: Warning Name	Possible Cause	Confirmation	Correction	Reference
A.97A: Command Warning 7 (Phase Error)	A command that cannot be executed in the current phase was sent.	-	Send the command after the command conditions are satisfied.	-
A.97b: Data Clamp Out of Range	The set command data was clamped to the minimum or maximum value of the setting range.	-	Set the command data within the setting ranges.	-
A.9A0: Overtravel (Overtravel status was detected.)	Overtravel was detected while the servo was ON.	Check the status of the overtravel signals on the input signal monitor.	Even if an overtravel signal is not shown by the input signal monitor, momentary overtravel may have been detected. Take the following precautions. <ul style="list-style-type: none"> <li>• Do not specify movements that would cause overtravel from the host controller.</li> <li>• Check the wiring of the overtravel signals.</li> <li>• Implement countermeasures against noise.</li> </ul>	page 5-31
A.9b0: Preventative Maintenance Warning	One of the consumable parts has reached the end of its service life.	-	Replace the part. Contact your Yaskawa representative for replacement.	page 9-16



## 10.4 Monitoring Communications Data during Alarms or Warnings

You can monitor the command data that is received when an alarm or warning occurs, such as a data setting warning (A.94□) or a command warning (A.95□) by using the following parameters. The following is an example of the data when an alarm or warning has occurred in the normal state.

Command Data during Alarms and Warnings: Pn890 to Pn8A6

Response Data during Alarms and Warnings: Pn8A8 to Pn8BE

Command Byte Sequence	Command Data Storage When an Alarm or Warning Occurs	
	CMD	RSP
0	Pn890 = n.□□□□□□XX	Pn8A8 = n.□□□□□□XX
1	Pn890 = n.□□□□XX□□	Pn8A8 = n.□□□□XX□□
2	Pn890 = n.□□XX□□□□	Pn8A8 = n.□□XX□□□□
3	Pn890 = n.XX□□□□□□	Pn8A8 = n.XX□□□□□□
4 to 7	Pn892	Pn8AA
8 to 11	Pn894	Pn8AC
12 to 15	Pn896	Pn8AE
16 to 19	Pn898	Pn8B0
20 to 23	Pn89A	Pn8B2
24 to 27	Pn89C	Pn8B4
28 to 31	Pn89E	Pn8B6
32 to 35	Pn8A0	Pn8B8
36 to 39	Pn8A2	Pn8BA
40 to 43	Pn8A4	Pn8BC
44 to 47	Pn8A6	Pn8BE

Note: 1. Data is stored in little endian byte order and displayed in the hexadecimal.

2. Refer to the following manual for command details.

📖  $\Sigma$ -7-Series MECHATROLINK-III Communications Standard Servo Profile Command Manual (Manual No.: SIEP S800001 31)

## 10.5 Troubleshooting Based on the Operation and Conditions of the Servomotor

This section provides troubleshooting based on the operation and conditions of the Servomotor, including causes and corrections.

Problem	Possible Cause	Confirmation	Correction	Reference
Servomotor Does Not Start	The control power supply is not turned ON.	Measure the voltage between control power supply terminals.	Turn OFF the power supply to the servo system. Correct the wiring so that the control power supply is turned ON.	-
	The main circuit power supply is not turned ON.	Measure the voltage across the main circuit power input terminals.	Turn OFF the power supply to the servo system. Correct the wiring so that the main circuit power supply is turned ON.	-
	The I/O signal connector (CN1) pins are not wired correctly or are disconnected.	Turn OFF the power supply to the servo system. Check the wiring condition of the I/O signal connector (CN1) pins.	Correct the wiring of the I/O signal connector (CN1) pins.	page 4-33, page 9-5
	The wiring for the Servomotor Main Circuit Cables or Encoder Cable is disconnected.	Check the wiring conditions.	Turn OFF the power supply to the servo system. Wire the cable correctly.	-
	There is an overload on the Servomotor.	Operate the Servomotor with no load and check the load status.	Turn OFF the power supply to the servo system. Reduce the load or replace the Servomotor with a larger capacity.	-
	The type of encoder that is being used does not agree with the setting of Pn002 = n.□X□□ (Encoder Usage).	Check the type of the encoder that is being used and the setting of Pn002 = n.□X□□.	Set Pn002 = n.□X□□ according to the type of the encoder that is being used.	page 6-27
	There is a mistake in the input signal allocations (Pn50A, Pn50B, Pn511, Pn516, or Pn590 to Pn599).	Check the input signal allocations (Pn50A, Pn50B, Pn511, Pn516, and Pn590 to Pn599).	Correctly allocate the input signals (Pn50A, Pn50B, Pn511, Pn516, and Pn590 to Pn599).	page 6-3, page 9-5
	The SV_ON command was not sent.	Check the commands sent from the host controller.	Send the SV_ON command from the host controller.	-
	The SENS_ON (Turn ON Sensor) command was not sent.	Check the commands sent from the host controller.	Send the commands to the SERVOPACK in the correct sequence.	-
	The P-OT (Forward Drive Prohibit) or N-OT (Reverse Drive Prohibit) signal is still OFF.	Check the P-OT and N-OT signals.	Turn ON the P-OT and N-OT signals.	page 9-5
The FSTP (Forced Stop Input) signal is still OFF.	Check the FSTP signal.	<ul style="list-style-type: none"> <li>Turn ON the FSTP signal.</li> <li>If you will not use the function to force the motor to stop, set Pn516 = n.□□□X (FSTP (Forced Stop Input) Signal Allocation) to disable the signal.</li> </ul>	page 9-5	

Continued on next page.

Continued from previous page.

Problem	Possible Cause	Confirmation	Correction	Reference
Servomotor Does Not Start	A failure occurred in the SERVOPACK.	-	Turn OFF the power supply to the servo system. Replace the SERVOPACK.	-
	The polarity detection was not executed.	Check the setting of Pn080 = n.□□□X (Polarity Sensor Selection).	Correct the parameter setting.	page 5-24
		Check the inputs to the SV_ON (Servo ON) command.	<ul style="list-style-type: none"> <li>If you are using an incremental linear encoder, send the SV_ON command from the host controller.</li> <li>If you are using an absolute linear encoder, execute polarity detection.</li> </ul>	page 5-25
Servomotor Moves Instantaneously, and Then Stops	There is a mistake in the Servomotor wiring.	Turn OFF the power supply to the servo system. Check the wiring.	Wire the Servomotor correctly.	-
	There is a mistake in the wiring of the encoder or Serial Converter Unit.	Turn OFF the power supply to the servo system. Check the wiring.	Wire the Serial Converter Unit correctly.	-
	There is a mistake in the linear encoder wiring.	Turn OFF the power supply to the servo system. Check the wiring.	Wire the cable correctly.	-
	The setting of Pn282 (Linear Encoder Pitch) is not correct.	Check the setting of Pn282.	Correct the setting of Pn282.	page 5-17
	The count-up direction of the linear encoder does not match the forward direction of the Moving Coil in the motor.	Check the directions.	Change the setting of Pn080 = n.□□□X□ (Motor Phase Selection). Place the linear encoder and motor in the same direction.	page 5-22
	Polarity detection was not performed correctly.	Check to see if electrical angle 2 (electrical angle from polarity origin) at any position is between $\pm 10^\circ$ .	Correct the settings for the polarity detection-related parameters.	-
Servomotor Speed Is Unstable	There is a faulty connection in the Servomotor wiring.	The connector connections for the power line (U, V, and W phases) and the encoder or Serial Converter Unit may be unstable. Turn OFF the power supply to the servo system. Check the wiring.	Tighten any loose terminals or connectors and correct the wiring.	-
Servomotor Moves without a Reference Input	A failure occurred in the SERVOPACK.	-	Turn OFF the power supply to the servo system. Replace the SERVOPACK.	-
	The count-up direction of the linear encoder does not match the forward direction of the Moving Coil in the motor.	Check the directions.	Change the setting of Pn080 = n.□□□X□ (Motor Phase Selection). Match the linear encoder direction and Servomotor direction.	page 5-22

Continued on next page.

Continued from previous page.

Problem	Possible Cause	Confirmation	Correction	Reference
Servomotor Moves without a Reference Input	Polarity detection was not performed correctly.	Check to see if electrical angle 2 (electrical angle from polarity origin) at any position is between $\pm 10^\circ$ .	Correct the settings for the polarity detection-related parameters.	-
	The setting of Pn001 = n.□□□X (Servo OFF or Alarm Group 1 Stopping Method) is not suitable.	Check the setting of Pn001 = n.□□□X.	Set Pn001 = n.□□□X correctly.	-
Dynamic Brake Does Not Operate	The dynamic brake resistor is disconnected.	Check the moment of inertia, motor speed, and dynamic brake frequency of use. If the moment of inertia, motor speed, or dynamic brake frequency of use is excessive, the dynamic brake resistance may be disconnected.	Turn OFF the power supply to the servo system. Replace the SERVO-PACK. To prevent disconnection, reduce the load.	-
	There was a failure in the dynamic brake drive circuit.	-	There is a defective component in the dynamic brake circuit. Turn OFF the power supply to the servo system. Replace the SERVO-PACK.	-
Abnormal Noise from Servomotor	The Servomotor vibrated considerably while performing the tuning-less function with the default settings.	Check the waveform of the motor speed.	Reduce the load so that the moment of inertia ratio or mass ratio is within the allowable value, or increase the load level or reduce the rigidity level in the tuning-less level settings. If the situation is not improved, disable the tuning-less function (i.e., set Pn170 to n.□□□0) and execute autotuning either with or without a host reference.	page 8-12
	The machine mounting is not secure.	Turn OFF the power supply to the servo system. Check to see if there are any loose mounting screws.	Tighten the mounting screws.	-
		Turn OFF the power supply to the servo system. Check to see if there is misalignment in the coupling.	Align the coupling.	-
		Turn OFF the power supply to the servo system. Check to see if the coupling is balanced.	Balance the coupling.	-
The bearings are defective.	Turn OFF the power supply to the servo system. Check for noise and vibration around the bearings.	Replace the Servomotor.	-	

Continued on next page.

Continued from previous page.

Problem	Possible Cause	Confirmation	Correction	Reference
Abnormal Noise from Servomotor	There is a vibration source at the driven machine.	Turn OFF the power supply to the servo system. Check for any foreign matter, damage, or deformation in the machine's moving parts.	Consult with the machine manufacturer.	-
	Noise interference occurred because of incorrect I/O signal cable specifications.	Turn OFF the power supply to the servo system. Check the I/O signal cables to see if they satisfy specifications. Use shielded twisted-pair wire cables or screened twisted-pair cables with conductors of at least 0.12 mm <sup>2</sup> .	Use cables that satisfy the specifications.	-
	Noise interference occurred because an I/O signal cable is too long.	Turn OFF the power supply to the servo system. Check the lengths of the I/O signal cables.	The I/O signal cables must be no longer than 3 m.	-
	Noise interference occurred because of incorrect Encoder Cable specifications.	Turn OFF the power supply to the servo system. Make sure that the rotary or Linear Encoder Cable satisfies the specifications. Use a shielded twisted-pair wire cable or a screened twisted-pair cable with a conductors of at least 0.12 mm <sup>2</sup> .	Use cables that satisfy the specifications.	-
	Noise interference occurred because the Encoder Cable is too long.	Turn OFF the power supply to the servo system. Check the length of the Encoder Cable.	<ul style="list-style-type: none"> <li>Rotary Servomotors: The Encoder Cable length must be 50 m max.</li> <li>Linear Servomotors: Make sure that the Serial Converter Unit cable is no longer than 20 m and that the Linear Encoder Cable and the Sensor Cable are no longer than 15 m each.</li> </ul>	-
	Noise interference occurred because the Encoder Cable is damaged.	Turn OFF the power supply to the servo system. Check the Encoder Cable to see if it is pinched or the sheath is damaged.	Replace the Encoder Cable and correct the cable installation environment.	-
	The Encoder Cable was subjected to excessive noise interference.	Turn OFF the power supply to the servo system. Check to see if the Encoder Cable is bundled with a high-current line or installed near a high-current line.	Correct the cable layout so that no surge is applied by high-current lines.	-
	There is variation in the FG potential because of the influence of machines on the Servomotor side, such as a welder.	Turn OFF the power supply to the servo system. Check to see if the machines are correctly grounded.	Properly ground the machines to separate them from the FG of the encoder.	-

Continued on next page.

Continued from previous page.

Problem	Possible Cause	Confirmation	Correction	Reference
Abnormal Noise from Servomotor	There is a SERVOPACK pulse counting error due to noise.	Check to see if there is noise interference on the signal line from the encoder.	Turn OFF the power supply to the servo system. Implement counter-measures against noise for the encoder wiring.	-
	The encoder was subjected to excessive vibration or shock.	Turn OFF the power supply to the servo system. Check to see if vibration from the machine occurred. Check the Servomotor installation (mounting surface precision, securing state, and alignment). Check the linear encoder installation (mounting surface precision and securing method).	Reduce machine vibration. Improve the mounting state of the Servomotor or linear encoder.	-
	A failure occurred in the encoder.	-	Turn OFF the power supply to the servo system. Replace the Servomotor.	-
	A failure occurred in the Serial Converter Unit.	-	Turn OFF the power supply to the servo system. Replace the Serial Converter Unit.	-
	A failure occurred in the linear encoder.	-	Turn OFF the power supply to the servo system. Replace the linear encoder.	-
Servomotor Vibrates at Frequency of Approx. 200 to 400 Hz.	The servo gains are not balanced.	Check to see if the servo gains have been correctly tuned.	Perform autotuning without a host reference.	page 8-24
	The setting of Pn100 (Speed Loop Gain) is too high.	Check the setting of Pn100. The default setting is Kv = 40.0 Hz.	Set Pn100 to an appropriate value.	-
	The setting of Pn102 (Position Loop Gain) is too high.	Check the setting of Pn102. The default setting is Kp = 40.0/s.	Set Pn102 to an appropriate value.	-
	The setting of Pn101 (Speed Loop Integral Time Constant) is not appropriate.	Check the setting of Pn101. The default setting is Ti = 20.0 ms.	Set Pn101 to an appropriate value.	-
	The setting of Pn103 (Moment of Inertia Ratio or Mass Ratio) is not appropriate.	Check the setting of Pn103.	Set Pn103 to an appropriate value.	-

Continued on next page.

Continued from previous page.

Problem	Possible Cause	Confirmation	Correction	Reference
Large Motor Speed Overshoot on Starting and Stopping	The servo gains are not balanced.	Check to see if the servo gains have been correctly tuned.	Perform autotuning without a host reference.	page 8-24
	The setting of Pn100 (Speed Loop Gain) is too high.	Check the setting of Pn100. The default setting is Kv = 40.0 Hz.	Set Pn100 to an appropriate value.	-
	The setting of Pn102 (Position Loop Gain) is too high.	Check the setting of Pn102. The default setting is Kp = 40.0/s.	Set Pn102 to an appropriate value.	-
	The setting of Pn101 (Speed Loop Integral Time Constant) is not appropriate.	Check the setting of Pn101. The default setting is Ti = 20.0 ms.	Set Pn101 to an appropriate value.	-
	The setting of Pn103 (Moment of Inertia Ratio or Mass Ratio) is not appropriate.	Check the setting of Pn103.	Set Pn103 to an appropriate value.	-
	The torque reference is saturated.	Check the waveform of the torque reference.	Use the mode switch.	-
	The force limits (Pn483 and Pn484) are set to the default values.	The default values of the force limits and Pn483 = 30% and Pn484 = 30%.	Set Pn483 and Pn484 to appropriate values.	page 6-22
Absolute Encoder Position Deviation Error (The position that was saved in the host controller when the power was turned OFF is different from the position when the power was next turned ON.)	Noise interference occurred because of incorrect Encoder Cable specifications.	Turn OFF the power supply to the servo system. Check the Encoder Cable to see if it satisfies specifications. Use a shielded twisted-pair wire cable or a screened twisted-pair cable with conductors of at least 0.12 mm <sup>2</sup> .	Use cables that satisfy the specifications.	-
	Noise interference occurred because the Encoder Cable is too long.	Turn OFF the power supply to the servo system. Check the length of the Encoder Cable.	<ul style="list-style-type: none"> <li>Rotary Servomotors: The Encoder Cable length must be 50 m max.</li> <li>Linear Servomotors: Make sure that the Serial Converter Unit cable is no longer than 20 m and that the Linear Encoder Cable and the Sensor Cable are no longer than 15 m each.</li> </ul>	-
	Noise interference occurred because the Encoder Cable is damaged.	Turn OFF the power supply to the servo system. Check the Encoder Cable to see if it is pinched or the sheath is damaged.	Replace the Encoder Cable and correct the cable installation environment.	-
	The Encoder Cable was subject to excessive noise interference.	Turn OFF the power supply to the servo system. Check to see if the Encoder Cable is bundled with a high-current line or installed near a high-current line.	Correct the cable layout so that no surge is applied by high-current lines.	-

Continued on next page.

Continued from previous page.

Problem	Possible Cause	Confirmation	Correction	Reference
Absolute Encoder Position Deviation Error (The position that was saved in the host controller when the power was turned OFF is different from the position when the power was next turned ON.)	There is variation in the FG potential because of the influence of machines on the Servomotor side, such as a welder.	Turn OFF the power supply to the servo system. Check to see if the machines are correctly grounded.	Properly ground the machines to separate them from the FG of the encoder.	-
	There is a SERVOPACK pulse counting error due to noise.	Turn OFF the power supply to the servo system. Check to see if there is noise interference on the I/O signal line from the encoder or Serial Converter Unit.	Implement countermeasures against noise for the encoder or Serial Converter Unit wiring.	-
	The encoder was subjected to excessive vibration or shock.	Turn OFF the power supply to the servo system. Check to see if vibration from the machine occurred. Check the Servomotor installation (mounting surface precision, securing state, and alignment). Check the linear encoder installation (mounting surface precision and securing method).	Reduce machine vibration. Improve the mounting state of the Servomotor or linear encoder.	-
	A failure occurred in the encoder.	-	Turn OFF the power supply to the servo system. Replace the Servomotor or linear encoder.	-
	A failure occurred in the SERVOPACK.	-	Turn OFF the power supply to the servo system. Replace the SERVOPACK.	-
	Host Controller Multiturn Data or Absolute Encoder Position Data Reading Error	Check the error detection section of the host controller.	Correct the error detection section of the host controller.	-
		Check to see if the host controller is executing data parity checks.	Perform parity checks for the multiturn data or absolute encoder position data.	-
Check for noise interference in the cable between the SERVOPACK and the host controller.		Implement countermeasures against noise and then perform parity checks again for the multiturn data or absolute encoder position data.	-	

Continued on next page.



Continued from previous page.

Problem	Possible Cause	Confirmation	Correction	Reference
Overtravel Occurred	The P-OT/N-OT (Forward Drive Prohibit or Reverse Drive Prohibit) signal was input.	Check the external power supply (+24 V) voltage for the input signals.	Correct the external power supply (+24 V) voltage for the input signals.	-
		Check the operating condition of the overtravel limit switches.	Make sure that the overtravel limit switches operate correctly.	-
		Check the wiring of the overtravel limit switches.	Correct the wiring of the overtravel limit switches.	page 5-28
		Check the settings of the overtravel input signal allocations (Pn50A/Pn50B or Pn590/Pn591).	Set the parameters to correct values.	page 5-28
	The P-OT/N-OT (Forward Drive Prohibit or Reverse Drive Prohibit) signal malfunctioned.	Check for fluctuation in the external power supply (+24 V) voltage for the input signals.	Eliminate fluctuation from the external power supply (+24 V) voltage for the input signals.	-
		Check to see if the operation of the overtravel limit switches is unstable.	Stabilize the operating condition of the overtravel limit switches.	-
		Check the wiring of the overtravel limit switches (e.g., check for cable damage and loose screws).	Correct the wiring of the overtravel limit switches.	-
	There is a mistake in the allocation of the P-OT or N-OT (Forward Drive Prohibit or Reverse Drive Prohibit) signal in Pn50A = n.X□□□ or Pn50B = n.□□□X.	Check to see if the P-OT signal is allocated in Pn50A = n.X□□□.	If another signal is allocated in Pn50A = n.X□□□, allocate the P-OT signal instead.	page 5-28
		Check to see if the N-OT signal is allocated in Pn50B = n.□□□X.	If another signal is allocated in Pn50B = n.□□□X, allocate the N-OT signal instead.	
	The selection of the Servomotor stopping method is not correct.	Check the servo OFF stopping method set in Pn001 = n.□□□X or Pn001 = n.□□X□.	Select a Servomotor stopping method other than coasting to a stop.	page 5-30
		Check the torque control stopping method set in Pn001 = n.□□□X or Pn001 = n.□□X□.	Select a Servomotor stopping method other than coasting to a stop.	
	Improper Stop Position for Overtravel (OT) Signal	The limit switch position and dog length are not appropriate.	-	Install the limit switch at the appropriate position.
The overtravel limit switch position is too close for the coasting distance.		-	Install the overtravel limit switch at the appropriate position.	-

Continued on next page.

Continued from previous page.

Problem	Possible Cause	Confirmation	Correction	Reference
Position Deviation (without Alarm)	Noise interference occurred because of incorrect Encoder Cable specifications.	Turn OFF the power supply to the servo system. Check the Encoder Cable to see if it satisfies specifications. Use a shielded twisted-pair wire cable or a screened twisted-pair cable with conductors of at least 0.12 mm <sup>2</sup> .	Use cables that satisfy the specifications.	-
	Noise interference occurred because the Encoder Cable is too long.	Turn OFF the power supply to the servo system. Check the length of the Encoder Cable.	<ul style="list-style-type: none"> <li>Rotary Servomotors: The Encoder Cable length must be 50 m max.</li> <li>Linear Servomotors: Make sure that the Serial Converter Unit cable is no longer than 20 m and that the Linear Encoder Cable and the Sensor Cable are no longer than 15 m each.</li> </ul>	-
	Noise interference occurred because the Encoder Cable is damaged.	Turn OFF the power supply to the servo system. Check the Encoder Cable to see if it is pinched or the sheath is damaged.	Replace the Encoder Cable and correct the cable installation environment.	-
	The Encoder Cable was subjected to excessive noise interference.	Turn OFF the power supply to the servo system. Check to see if the Encoder Cable is bundled with a high-current line or installed near a high-current line.	Correct the cable layout so that no surge is applied by high-current lines.	-
	There is variation in the FG potential because of the influence of machines on the Servomotor side, such as a welder.	Turn OFF the power supply to the servo system. Check to see if the machines are correctly grounded.	Properly ground the machines to separate them from the FG of the encoder.	-
	There is a SERVOPACK pulse counting error due to noise.	Turn OFF the power supply to the servo system. Check to see if there is noise interference on the I/O signal line from the encoder or Serial Converter Unit.	Implement countermeasures against noise for the encoder wiring or Serial Converter Unit wiring.	-
	The encoder was subjected to excessive vibration or shock.	Turn OFF the power supply to the servo system. Check to see if vibration from the machine occurred. Check the Servomotor installation (mounting surface precision, securing state, and alignment). Check the linear encoder installation (mounting surface precision and securing method).	Reduce machine vibration. Improve the mounting state of the Servomotor or linear encoder.	-

Continued on next page.

Continued from previous page.

Problem	Possible Cause	Confirmation	Correction	Reference
Position Deviation (without Alarm)	The coupling between the machine and Servomotor is not suitable.	Turn OFF the power supply to the servo system. Check to see if position offset occurs at the coupling between machine and Servomotor.	Correctly secure the coupling between the machine and Servomotor.	-
	Noise interference occurred because of incorrect I/O signal cable specifications.	Turn OFF the power supply to the servo system. Check the I/O signal cables to see if they satisfy specifications. Use a shielded twisted-pair wire cable or a screened twisted-pair cable with conductors of at least 0.12 mm <sup>2</sup> .	Use cables that satisfy the specifications.	-
	Noise interference occurred because an I/O signal cable is too long.	Turn OFF the power supply to the servo system. Check the lengths of the I/O signal cables.	The I/O signal cables must be no longer than 3 m.	-
	An encoder fault occurred. (The pulse count does not change.)	-	Turn OFF the power supply to the servo system. Replace the Servomotor or linear encoder.	-
	A failure occurred in the SERVOPACK.	-	Turn OFF the power supply to the servo system. Replace the SERVOPACK.	-
Servomotor Overheated	The surrounding air temperature is too high.	Measure the surrounding air temperature around the Servomotor.	Reduce the surrounding air temperature to 40°C or less.	-
	The surface of the Servomotor is dirty.	Turn OFF the power supply to the servo system. Visually check the surface for dirt.	Clean dirt, dust, and oil from the surface.	-
	There is an overload on the Servomotor.	Check the load status with a monitor.	If the Servomotor is overloaded, reduce the load or replace the Servo Drive with a SERVOPACK and Servomotor with larger capacities.	-
	Polarity detection was not performed correctly.	Check to see if electrical angle 2 (electrical angle from polarity origin) at any position is between ±10°.	Correct the settings for the polarity detection-related parameters.	-

# Parameter Lists

---

# 11

This chapter provides information on the parameters.

<b>11.1</b>	<b>List of Servo Parameters . . . . .</b>	<b>11-2</b>
11.1.1	Interpreting the Parameter Lists . . . . .	11-2
11.1.2	List of Servo Parameters . . . . .	11-3
<b>11.2</b>	<b>List of MECHATROLINK-III Common Parameters . .</b>	<b>11-54</b>
11.2.1	Interpreting the Parameter Lists . . . . .	11-54
11.2.2	List of MECHATROLINK-III Common Parameters . . . . .	11-54
<b>11.3</b>	<b>Parameter Recording Table . . . . .</b>	<b>11-63</b>

# 11.1 List of Servo Parameters

## 11.1.1 Interpreting the Parameter Lists

The types of Servomotors to which the parameter applies.

- All: The parameter is used for both Rotary Servomotors and Linear Servomotors.
- Rotary: The parameter is used for only Rotary Servomotors.
- Linear: The parameter is used for only Linear Servomotors.

Rotary Servomotor terms are used for parameters that are applicable to all Servomotors. If you are using a Linear Servomotor, you need to interpret the terms accordingly. Refer to the following section for details.

◆ Differences in Terms for Rotary Servomotors and Linear Servomotors on page x

“After restart” indicates parameters that will be effective after one of the following is executed.

- The power supply is turned OFF and ON again.
- The CONFIG command is sent.
- A software reset is executed.

Parameter No.	Size	Name	Setting Range	Setting Unit	Default Setting	Applicable Motors	When Enabled	Classification	Reference		
	2	Basic Function Selections 0	0000h to 10B1h	–	0000h	All	After restart	Setup	–		
Pn000  All Axes	n.□□□X	<p>Rotation Direction Selection</p> <p>Movement Direction Selection</p> <p>0</p> <p>Use CCW as the forward direction.</p> <p>Use the direction in which the linear encoder counts up as the forward direction.</p> <p>Use CW as the forward direction. (Reverse Rotation Mode)</p> <p>Use the direction in which the linear encoder counts down as the forward direction. (Reverse Rotation Mode)</p>							Reference	page 5-16	
		<p>Reserved parameter (Do not change.)</p>									
		<p>Rotary/Linear Servomotor Startup Selection When Encoder Is Not Connected</p> <p>When an encoder is not connected, start as SERVOPACK for Rotary Servomotor.</p>							Reference		page 5-15
		<p>1</p> <p>When an encoder is not connected, start as SERVOPACK for Linear Servomotor.</p>									

If there are differences in the parameters for Rotary Servomotor and Linear Servomotor, information is provided for both.

- Top row: For Rotary Servomotors
- Bottom row: For Linear Servomotors

There are the following two classifications.

- Setup
- Tuning

Refer to the following section for details.

5.1.1 Parameter Classification on page 5-3

Symbols are provided when a parameter is valid only for a specific profile.

- : Parameters that are valid only for a MECHATROLINK-II-compatible profile.
- : Parameters that are valid only for a MECHATROLINK-III standard servo profile.

This parameter applies to both axis A and axis B. If you change the setting, the new setting will be applied to both axes.

## 11.1.2 List of Servo Parameters

The following table lists the parameters.

Note: Do not change the following parameters from their default settings.

- Reserved parameters
- Parameters not given in this manual
- Parameters that are not valid for the Servomotor that you are using, as given in the parameter table

Parameter No.	Size	Name	Setting Range	Setting Unit	Default Setting	Applicable Motors	When Enabled	Classification	Reference	
Pn000	2	Basic Function Selections 0	0000h to 10B1h	–	0000h	All	After restart	Setup	–	
	n.□□□X	Rotation Direction Selection							Reference	page 5-16
		Movement Direction Selection								
		0	Use CCW as the forward direction.							
		Use the direction in which the linear encoder counts up as the forward direction.								
	1	Use CW as the forward direction. (Reverse Rotation Mode)								
	Use the direction in which the linear encoder counts down as the forward direction. (Reverse Movement Mode)									
	n.□□X□	Reserved parameter (Do not change.)								
	n.□X□□	Reserved parameter (Do not change.)								
	n.X□□□	Rotary/Linear Servomotor Startup Selection When Encoder Is Not Connected							Reference	page 5-15
0		When an encoder is not connected, start as SERVOPACK for Rotary Servomotor.								
1	When an encoder is not connected, start as SERVOPACK for Linear Servomotor.									
Pn001	2	Application Function Selections 1	0000h to 1142h	–	0000h	All	After restart	Setup	–	
	n.□□□X	Motor Stopping Method for Servo OFF and Group 1 Alarms							Reference	page 5-38
		0	Stop the motor by applying the dynamic brake.							
		1	Stop the motor by the applying dynamic brake and then release the dynamic brake.							
	2	Coast the motor to a stop without the dynamic brake.								
	n.□□X□	Overtravel Stopping Method							Reference	page 5-30
		0	Apply the dynamic brake or coast the motor to a stop (use the stopping method set in Pn001 = n.□□□X).							
		1	Decelerate the motor to a stop using the torque set in Pn406 as the maximum torque and then servo-lock the motor.							
		2	Decelerate the motor to a stop using the torque set in Pn406 as the maximum torque and then let the motor coast.							
		3	Decelerate the motor to a stop using the deceleration time set in Pn30A and then servo-lock the motor.							
4	Decelerate the motor to a stop using the deceleration time set in Pn30A and then let the motor coast.									
n.□X□□ All Axes	Main Circuit Power Supply AC/DC Input Selection							Reference	page 5-13	
	0	Input AC power as the main circuit power supply using the L1, L2, and L3 terminals (do not use shared converter).								
1	Input DC power as the main circuit power supply using the B1/⊕ and ⊖ 2 terminals or the B1 and ⊖ 2 terminals (use an external converter or the shared converter).									
n.X□□□	Reserved parameter (Do not change.)									

Continued on next page.

11.1 List of Servo Parameters

11.1.2 List of Servo Parameters

Continued from previous page.

Parameter No.	Size	Name	Setting Range	Setting Unit	Default Setting	Applicable Motors	When Enabled	Classification	Reference	
Pn002	2	Application Function Selections 2	0000h to 4213h	-	0011h	-	After restart	Setup	-	
			<b>MECHATROLINK Command Position and Speed Control Option</b>				<b>Applicable Motors</b>	<b>Reference</b>		
	n.□□□X		0	Reserved setting (Do not use.)			All	*1		
			1	Use TLIM as the torque limit.						
			2	Reserved setting (Do not use.)						
			3	Use P_TLIM or N_TLIM as the torque limit when P_CL or N_CL in the OPTION field is ON.						
			<b>Torque Control Option</b>				<b>Applicable Motors</b>	<b>Reference</b>		
	n.□□X□		0	Reserved setting (Do not use.)			All	*1		
			1	Use the speed limit for torque control (VLIM) as the speed limit.						
			<b>Encoder Usage</b>				<b>Applicable Motors</b>	<b>Reference</b>		
	n.□X□□		0	Use the encoder according to encoder specifications.			All	page 6-27		
			1	Use the encoder as an incremental encoder.						
			2	Use the encoder as a single-turn absolute encoder.			Rotary			
	n.X□□□		Reserved parameter (Do not change.)							

Continued on next page.

Continued from previous page.

Parameter No.	Size	Name	Setting Range	Setting Unit	Default Setting	Applicable Motors	When Enabled	Classification	Reference		
Pn006 All Axes	2	Application Function Selections 6	0000h to 105Fh	-	0002h	All	Immediately	Setup	page 9-8		
	n.DDXX	<b>Analog Monitor 1 Signal Selection</b>									
		00	Motor speed (1 V/1,000 min <sup>-1</sup> ) Motor speed (1 V/1,000 mm/s)								
		01	Speed reference (1 V/1,000 min <sup>-1</sup> ) Speed reference (1 V/1,000 mm/s)								
		02	Torque reference (1 V/100% rated torque) Force reference (1 V/100% rated force)								
		03	Position deviation (0.05 V/reference unit)								
		04	Position amplifier deviation (after electronic gear) (0.05 V/encoder pulse unit) Position amplifier deviation (after electronic gear) (0.05 V/linear encoder pulse unit)								
		05	Position reference speed (1 V/1,000 min <sup>-1</sup> ) Position reference speed (1 V/1,000 mm/s)								
		06	Reserved setting (Do not use.)								
		07	Reserved setting (Do not use.)								
		08	Positioning completion (positioning completed: 5 V, positioning not completed: 0 V)								
		09	Speed feedforward (1 V/1,000 min <sup>-1</sup> ) Speed feedforward (1 V/1,000 mm/s)								
		0A	Torque feedforward (1 V/100% rated torque) Force feedforward (1 V/100% rated force)								
		0B	Active gain (1st gain: 1 V, 2nd gain: 2 V)								
		0C	Completion of position reference distribution (completed: 5 V, not completed: 0 V)								
		0D	Reserved setting (Do not use.)								
		0E	Reserved setting (Do not use.)								
		0F	Reserved setting (Do not use.)								
		10	Main circuit DC voltage								
		11 to 5F	Reserved settings (Do not use.)								
		n.DXDD	Reserved parameter (Do not change.)								
		n.XDDD	<b>Output Axis Selection</b>								
			0	Output axis A data.							
			1	Output axis B data.							

Continued on next page.



11.1 List of Servo Parameters

11.1.2 List of Servo Parameters

Continued from previous page.

Parameter No.	Size	Name	Setting Range	Setting Unit	Default Setting	Applicable Motors	When Enabled	Classification	Reference	
Pn007 All Axes	2	Application Function Selections 7	0000h to 105Fh	–	0000h	All	Immediately	Setup	page 9-8	
	n.□□XX	<b>Analog Monitor 2 Signal Selection</b>								
		00	Motor speed (1 V/1,000 min <sup>-1</sup> )							
			Motor speed (1 V/1,000 mm/s)							
		01	Speed reference (1 V/1,000 min <sup>-1</sup> )							
			Speed reference (1 V/1,000 mm/s)							
		02	Torque reference (1 V/100% rated torque)							
			Force reference (1 V/100% rated force)							
		03	Position deviation (0.05 V/reference unit)							
		04	Position amplifier deviation (after electronic gear) (0.05 V/encoder pulse unit)							
			Position amplifier deviation (after electronic gear) (0.05 V/linear encoder pulse unit)							
		05	Position reference speed (1 V/1,000 min <sup>-1</sup> )							
			Position reference speed (1 V/1,000 mm/s)							
		06	Reserved setting (Do not use.)							
		07	Reserved setting (Do not use.)							
		08	Positioning completion (positioning completed: 5 V, positioning not completed: 0 V)							
		09	Speed feedforward (1 V/1,000 min <sup>-1</sup> )							
			Speed feedforward (1 V/1,000 mm/s)							
		0A	Torque feedforward (1 V/100% rated torque)							
			Force feedforward (1 V/100% rated force)							
		0B	Active gain (1st gain: 1 V, 2nd gain: 2 V)							
		0C	Completion of position reference distribution (completed: 5 V, not completed: 0 V)							
		0D	Reserved setting (Do not use.)							
		0E	Reserved setting (Do not use.)							
		0F	Reserved setting (Do not use.)							
		10	Main circuit DC voltage							
		11 to 5F	Reserved settings (Do not use.)							
		n.□X□□	Reserved parameter (Do not change.)							
n.X□□□	<b>Output Axis Selection</b>									
	0	Output axis A data.								
	1	Output axis B data.								

Continued on next page.

Continued from previous page.

Parameter No.	Size	Name	Setting Range	Setting Unit	Default Setting	Applicable Motors	When Enabled	Classification	Reference	
Pn008	2	Application Function Selections 8	0000h to 7121h	–	4000h	Rotary	After restart	Setup	–	
	n.□□□X	Low Battery Voltage Alarm/Warning Selection							Reference	page 10-2
		0	Output alarm (A.830) for low battery voltage.							
	n.□□X□	Function Selection for Undervoltage							Reference	page 6-18
		0	Do not detect undervoltage.							
		1	Detect undervoltage warning and limit torque at host controller.							
	n.□X□□	Warning Detection Selection							Reference	page 10-42
		0	Detect warnings.							
	n.X□□□	Reserved parameter (Do not change.)								
Pn009	2	Application Function Selections 9	0000h to 0121h	–	0010h	All	After restart	Tuning	–	
	n.□□□X	Reserved parameter (Do not change.)								
	n.□□X□	Current Control Mode Selection							Reference	page 8-75
		0	Use current control mode 1.							
		1	Use current control mode 2.							
	n.□X□□	Speed Detection Method Selection							Reference	page 8-72
		0	Use speed detection 1.							
	n.X□□□	Reserved parameter (Do not change.)								

Continued on next page.

11.1 List of Servo Parameters

11.1.2 List of Servo Parameters

Continued from previous page.

Parameter No.	Size	Name	Setting Range	Setting Unit	Default Setting	Applicable Motors	When Enabled	Classification	Reference	
Pn00A	2	Application Function Selections A	0000h to 1044h	–	0001h	All	After restart	Setup	–	
	n.□□□X	<b>Motor Stopping Method for Group 2 Alarms</b>								<b>Reference</b>
		0	Apply the dynamic brake or coast the motor to a stop (use the stopping method set in Pn001 = n.□□□X).							page 5-39
		1	Decelerate the motor to a stop using the torque set in Pn406 as the maximum torque. Use the setting of Pn001 = n.□□□X for the status after stopping.							
		2	Decelerate the motor to a stop using the torque set in Pn406 as the maximum torque and then let the motor coast.							
		3	Decelerate the motor to a stop using the deceleration time set in Pn30A. Use the setting of Pn001 = n.□□□X for the status after stopping.							
	4	Decelerate the motor to a stop using the deceleration time set in Pn30A and then let the motor coast.								
	n.□□□□	<b>Stopping Method for Forced Stops</b>								<b>Reference</b>
		0	Apply the dynamic brake or coast the motor to a stop (use the stopping method set in Pn001 = n.□□□X).							page 6-46
		1	Decelerate the motor to a stop using the torque set in Pn406 as the maximum torque. Use the setting of Pn001 = n.□□□X for the status after stopping.							
		2	Decelerate the motor to a stop using the torque set in Pn406 as the maximum torque and then let the motor coast.							
		3	Decelerate the motor to a stop using the deceleration time set in Pn30A. Use the setting of Pn001 = n.□□□X for the status after stopping.							
4	Decelerate the motor to a stop using the deceleration time set in Pn30A and then let the motor coast.									
n.□X□□	Reserved parameter (Do not change.)									
n.X□□□	Reserved parameter (Do not change.)									
Pn00B	2	Application Function Selections B	0000h to 1121h	–	0000h	All	After restart	Setup	–	
	n.□□□X	<b>Operator Parameter Display Selection</b>								<b>Reference</b>
		0	Display only setup parameters.							page 5-3
	1	Display all parameters.								
	n.□□□□	<b>Motor Stopping Method for Group 2 Alarms</b>								<b>Reference</b>
		0	Stop the motor by setting the speed reference to 0.							page 5-39
		1	Apply the dynamic brake or coast the motor to a stop (use the stopping method set in Pn001 = n.□□□X).							
	2	Set the stopping method with Pn00A = n.□□□X.								
	n.□X□□ All Axes	<b>Power Input Selection for Three-phase SERVOPACK</b>								<b>Reference</b>
		0	Use a three-phase power supply input.							page 5-14
1	Use a three-phase power supply input and as a single-phase power supply input.									
n.X□□□	Reserved parameter (Do not change.)									

Continued on next page.

Continued from previous page.

Parameter No.	Size	Name	Setting Range	Setting Unit	Default Setting	Applicable Motors	When Enabled	Classification	Reference		
Pn00C	2	Application Function Selections C	0000h to 0131h	-	0000h	-	After restart	Setup	page 7-23		
	n.□□□X	Function Selection for Test without a Motor							Applicable Motors		
		0	Disable tests without a motor.							All	
		1	Enable tests without a motor.								
	n.□□X□	Encoder Resolution for Tests without a Motor							Applicable Motors		
		0	Use 13 bits.							Rotary	
		1	Use 20 bits.								
		2	Use 22 bits.								
	3	Use 24 bits.									
	n.□X□□	Encoder Type Selection for Tests without a Motor							Applicable Motors		
0		Use an incremental encoder.							All		
	1	Use an absolute encoder.									
	n.X□□□	Reserved parameter (Do not change.)									
Pn00D	2	Application Function Selections D	0000h to 1001h	-	0000h	All	After restart	Setup	page 5-31		
		n.□□□X	Reserved parameter (Do not change.)								
		n.□□X□	Reserved parameter (Do not change.)								
		n.□X□□	Reserved parameter (Do not change.)								
	n.X□□□	Overtravel Warning Detection Selection									
		0	Do not detect overtravel warnings.								
	1	Detect overtravel warnings.									
Pn00F All Axes	2	Application Function Selections F	0000h to 2011h	-	0000h	All	After restart	Setup	-		
	n.□□□X	Preventative Maintenance Warning Selection							Reference		
		0	Do not detect preventative maintenance warnings.							page 9-16	
		1	Detect preventative maintenance warnings.								
		n.□□X□	Reserved parameter (Do not change.)								
		n.□X□□	Reserved parameter (Do not change.)								
		n.X□□□	Reserved parameter (Do not change.)								
Pn021	2	Reserved parameter (Do not change.)	-	-	0000h	All	-	-	-		
Pn022	2	Reserved parameter (Do not change.)	-	-	0000h	All	-	-	-		

Continued on next page.

11.1 List of Servo Parameters

11.1.2 List of Servo Parameters

Continued from previous page.

Parameter No.	Size	Name	Setting Range	Setting Unit	Default Setting	Applicable Motors	When Enabled	Classification	Reference
Pn080	2	Application Function Selections 80	0000h to 1111h	–	0000h	Linear	After restart	Setup	–
	n.□□□X	Polarity Sensor Selection							Reference
		0	Use polarity sensor.						
	1	Do not use polarity sensor.							
	n.□□X□	Motor Phase Sequence Selection							Reference
		0	Set a phase-A lead as a phase sequence of U, V, and W.						
	1	Set a phase-B lead as a phase sequence of U, V, and W.							
n.□X□□	Reserved parameter (Do not change.)								
n.X□□□	Reserved parameter (Do not change.)								
Pn100	2	Speed Loop Gain	10 to 20,000	0.1 Hz	400	All	Immediately	Tuning	page 8-82
Pn101	2	Speed Loop Integral Time Constant	15 to 51,200	0.01 ms	2000	All	Immediately	Tuning	page 8-82
Pn102	2	Position Loop Gain	10 to 20,000	0.1/s	400	All	Immediately	Tuning	page 8-82
Pn103	2	Moment of Inertia Ratio	0 to 20,000	1%	100	All	Immediately	Tuning	page 8-82
Pn104	2	Second Speed Loop Gain	10 to 20,000	0.1 Hz	400	All	Immediately	Tuning	page 8-68
Pn105	2	Second Speed Loop Integral Time Constant	15 to 51,200	0.01 ms	2000	All	Immediately	Tuning	page 8-68
Pn106	2	Second Position Loop Gain	10 to 20,000	0.1/s	400	All	Immediately	Tuning	page 8-68
Pn109	2	Feedforward	0 to 100	1%	0	All	Immediately	Tuning	page 8-92
Pn10A	2	Feedforward Filter Time Constant	0 to 6,400	0.01 ms	0	All	Immediately	Tuning	page 8-92

Continued on next page.

Continued from previous page.

Parameter No.	Size	Name	Setting Range	Setting Unit	Default Setting	Applicable Motors	When Enabled	Classification	Reference	
Pn10B	2	Gain Application Selections	0000h to 5334h	-	0000h	All	-	Setup	-	
	n.□□□X	Mode Switching Selection						When Enabled	Reference	page 8-93
		0	Use the internal torque reference as the condition (level setting: Pn10C).					Immediately		
		1	Use the speed reference as the condition (level setting: Pn10D).							
			Use the speed reference as the condition (level setting: Pn181).							
		2	Use the acceleration reference as the condition (level setting: Pn10E).							
			Use the acceleration reference as the condition (level setting: Pn182).							
	3	Use the position deviation as the condition (level setting: Pn10F).								
	4	Do not use mode switching.								
	n.□□□□	Speed Loop Control Method						When Enabled	Reference	page 8-88
0		PI control					After restart			
1		I-P control								
2 and 3		Reserved settings (Do not use.)								
n.□□□□	Reserved parameter (Do not change.)									
n.X□□□	Reserved parameter (Do not change.)									
Pn10C	2	Mode Switching Level for Torque Reference	0 to 800	1%	200	All	Immediately	Tuning	page 8-93	
Pn10D	2	Mode Switching Level for Speed Reference	0 to 10,000	1 min <sup>-1</sup>	0	Rotary	Immediately	Tuning	page 8-93	
Pn10E	2	Mode Switching Level for Acceleration	0 to 30,000	1 min <sup>-1</sup> /s	0	Rotary	Immediately	Tuning	page 8-93	
Pn10F	2	Mode Switching Level for Position Deviation	0 to 10,000	1 reference unit	0	All	Immediately	Tuning	page 8-93	
Pn11F	2	Position Integral Time Constant	0 to 50,000	0.1 ms	0	All	Immediately	Tuning	page 8-95	
Pn121	2	Friction Compensation Gain	10 to 1,000	1%	100	All	Immediately	Tuning	page 8-68, page 8-72	
Pn122	2	Second Friction Compensation Gain	10 to 1,000	1%	100	All	Immediately	Tuning	page 8-68, page 8-72	
Pn123	2	Friction Compensation Coefficient	0 to 100	1%	0	All	Immediately	Tuning	page 8-72	
Pn124	2	Friction Compensation Frequency Correction	-10,000 to 10,000	0.1 Hz	0	All	Immediately	Tuning	page 8-72	
Pn125	2	Friction Compensation Gain Correction	1 to 1,000	1%	100	All	Immediately	Tuning	page 8-72	
Pn131	2	Gain Switching Time 1	0 to 65,535	1 ms	0	All	Immediately	Tuning	page 8-68	
Pn132	2	Gain Switching Time 2	0 to 65,535	1 ms	0	All	Immediately	Tuning	page 8-68	
Pn135	2	Gain Switching Waiting Time 1	0 to 65,535	1 ms	0	All	Immediately	Tuning	page 8-68	
Pn136	2	Gain Switching Waiting Time 2	0 to 65,535	1 ms	0	All	Immediately	Tuning	page 8-68	

Continued on next page.

11.1 List of Servo Parameters

11.1.2 List of Servo Parameters

Continued from previous page.

Parameter No.	Size	Name	Setting Range	Setting Unit	Default Setting	Applicable Motors	When Enabled	Classification	Reference
Pn139	2	Automatic Gain Switching Selections 1	0000h to 0052h	-	0000h	All	Immediately	Tuning	page 8-68
	n.□□□X	Gain Switching Selection							
		0	Use manual gain switching. The gain is switched manually with G-SEL in the servo command output signals (SVCMD_IO).						
		1	Reserved setting (Do not use.)						
	2	Use automatic gain switching pattern 1. The gain is switched automatically from the first gain to the second gain when switching condition A is satisfied. The gain is switched automatically from the second gain to the first gain when switching condition A is not satisfied.							
	n.□□X□	Gain Switching Condition A							
		0	/COIN (Positioning Completion Output) signal turns ON.						
		1	/COIN (Positioning Completion Output) signal turns OFF.						
		2	/NEAR (Near Output) signal turns ON.						
		3	/NEAR (Near Output) signal turns OFF.						
4		Position reference filter output is 0 and position reference input is OFF.							
n.□X□□	Reserved parameter (Do not change.)								
n.X□□□	Reserved parameter (Do not change.)								
Pn13D	2	Current Gain Level	100 to 2,000	1%	2000	All	Immediately	Tuning	page 8-75
Pn140	2	Model Following Control-Related Selections	0000h to 1121h	-	0100h	All	Immediately	Tuning	-
	n.□□□X	Model Following Control Selection							Reference
		0	Do not use model following control.						page 8-89
	1	Use model following control.							
	n.□□X□	Vibration Suppression Selection							Reference
		0	Do not perform vibration suppression.						page 8-89
		1	Perform vibration suppression for a specific frequency.						
	2	Perform vibration suppression for two specific frequencies.							
	n.□X□□	Vibration Suppression Adjustment Selection							Reference
		0	Do not adjust vibration suppression automatically during execution of autotuning without a host reference, autotuning with a host reference, and custom tuning.						page 8-32
1	Adjust vibration suppression automatically during execution of autotuning without a host reference, autotuning with a host reference, and custom tuning.								
n.X□□□	Speed Feedforward (VFF)/Torque Feedforward (TFF) Selection							Reference	
	0	Do not use model following control and speed/torque feedforward together.						page 8-33, page 8-61	
1	Use model following control and speed/torque feedforward together.								
Pn141	2	Model Following Control Gain	10 to 20,000	0.1/s	500	All	Immediately	Tuning	page 8-89
Pn142	2	Model Following Control Gain Correction	500 to 2,000	0.1%	1000	All	Immediately	Tuning	page 8-68
Pn143	2	Model Following Control Bias in the Forward Direction	0 to 10,000	0.1%	1000	All	Immediately	Tuning	page 8-89

Continued on next page.

Continued from previous page.

Parameter No.	Size	Name	Setting Range	Setting Unit	Default Setting	Applicable Motors	When Enabled	Classification	Reference	
Pn144	2	Model Following Control Bias in the Reverse Direction	0 to 10,000	0.1%	1000	All	Immediately	Tuning	page 8-89	
Pn145	2	Vibration Suppression 1 Frequency A	10 to 2,500	0.1 Hz	500	All	Immediately	Tuning	page 8-61	
Pn146	2	Vibration Suppression 1 Frequency B	10 to 2,500	0.1 Hz	700	All	Immediately	Tuning	page 8-61	
Pn147	2	Model Following Control Speed Feedforward Compensation	0 to 10,000	0.1%	1000	All	Immediately	Tuning	page 8-89	
Pn148	2	Second Model Following Control Gain	10 to 20,000	0.1/s	500	All	Immediately	Tuning	page 8-68	
Pn149	2	Second Model Following Control Gain Correction	500 to 2,000	0.1%	1000	All	Immediately	Tuning	page 8-68	
Pn14A	2	Vibration Suppression 2 Frequency	10 to 2,000	0.1 Hz	800	All	Immediately	Tuning	page 8-61	
Pn14B	2	Vibration Suppression 2 Correction	10 to 1,000	1%	100	All	Immediately	Tuning	page 8-61	
Pn14F	2	Control-Related Selections	0000h to 0021h	-	0021h	All	After restart	Tuning	-	
	n.□□□X		<b>Model Following Control Type Selection</b>						<b>Reference</b>	
			0	Use model following control type 1.						page 8-92
			1	Use model following control type 2.						
	n.□□□X		<b>Tuning-less Type Selection</b>						<b>Reference</b>	
			0	Use tuning-less type 1.						page 8-13
		1	Use tuning-less type 2.							
		2	Use tuning-less type 3.							
n.□X□□		Reserved parameter (Do not change.)								
n.X□□□		Reserved parameter (Do not change.)								
Pn160	2	Anti-Resonance Control-Related Selections	0000h to 0011h	-	0010h	All	Immediately	Tuning	-	
	n.□□□X		<b>Anti-Resonance Control Selection</b>						<b>Reference</b>	
			0	Do not use anti-resonance control.						page 8-52
			1	Use anti-resonance control.						
	n.□□□X		<b>Anti-Resonance Control Adjustment Selection</b>						<b>Reference</b>	
			0	Do not adjust anti-resonance control automatically during execution of autotuning without a host reference, autotuning with a host reference, and custom tuning.						page 8-32
		1	Adjust anti-resonance control automatically during execution of autotuning without a host reference, autotuning with a host reference, and custom tuning.							
n.□X□□		Reserved parameter (Do not change.)								
n.X□□□		Reserved parameter (Do not change.)								
Pn161	2	Anti-Resonance Frequency	10 to 20,000	0.1 Hz	1000	All	Immediately	Tuning	page 8-52	
Pn162	2	Anti-Resonance Gain Correction	1 to 1,000	1%	100	All	Immediately	Tuning	page 8-52	
Pn163	2	Anti-Resonance Damping Gain	0 to 300	1%	0	All	Immediately	Tuning	page 8-52	

Continued on next page.



11.1 List of Servo Parameters

11.1.2 List of Servo Parameters

Continued from previous page.

Parameter No.	Size	Name	Setting Range	Setting Unit	Default Setting	Applicable Motors	When Enabled	Classification	Reference	
Pn164	2	Anti-Resonance Filter Time Constant 1 Correction	-1,000 to 1,000	0.01 ms	0	All	Immediately	Tuning	page 8-52	
Pn165	2	Anti-Resonance Filter Time Constant 2 Correction	-1,000 to 1,000	0.01 ms	0	All	Immediately	Tuning	page 8-52	
Pn166	2	Anti-Resonance Damping Gain 2	0 to 1,000	1%	0	All	Immediately	Tuning	page 8-55	
Pn170	2	Tuning-less Function-Related Selections	0000h to 2711h	-	1401h	All	-	Setup	page 8-12	
	n.□□□X		Tuning-less Selection					When Enabled		
			0	Disable tuning-less function.				After restart		
			1	Enable tuning-less function.						
	n.□□□□		Speed Control Method					When Enabled		
			0	Use for speed control.				After restart		
		1	Use for speed control and use host controller for position control.							
n.□X□□		Rigidity Level					When Enabled			
		0 to 7	Set the rigidity level.				Immediately			
n.X□□□		Tuning-less Load Level					When Enabled			
		0 to 2	Set the load level for the tuning-less function.				Immediately			
Pn181	2	Mode Switching Level for Speed Reference	0 to 10,000	1 mm/s	0	Linear	Immediately	Tuning	page 8-93	
Pn182	2	Mode Switching Level for Acceleration	0 to 30,000	1 mm/s <sup>2</sup>	0	Linear	Immediately	Tuning	page 8-93	
Pn205	2	Multiturn Limit	0 to 65,535	1 rev	65535	Rotary	After restart	Setup	page 6-28	
Pn207	2	Position Control Function Selections	0000h to 2210h	-	0010h	All	After restart	Setup	-	
	n.□□□X		Reserved parameter (Do not change.)							
	n.□□□□		Reserved parameter (Do not change.)							
	n.□X□□		Reserved parameter (Do not change.)							
	n.X□□□		/COIN (Positioning Completion Output) Signal Output Timing						Reference	
			0	Output when the absolute value of the position deviation is the same or less than the setting of Pn522 (Positioning Completed Width).				page 6-14		
		1	Output when the absolute value of the position error is the same or less than the setting of Pn522 (Positioning Completed Width) and the reference after the position reference filter is 0.							
		2	Output when the absolute value of the position error is the same or less than the setting of Pn522 (Positioning Completed Width) and the reference input is 0.							
Pn20E	4	Electronic Gear Ratio (Numerator)	1 to 1,073,741,824	1	16	All	After restart	Setup	page 5-44	
Pn210	4	Electronic Gear Ratio (Denominator)	1 to 1,073,741,824	1	1	All	After restart	Setup	page 5-44	

Continued on next page.

Continued from previous page.

Parameter No.	Size	Name	Setting Range	Setting Unit	Default Setting	Applicable Motors	When Enabled	Classification	Reference
Pn230	2	Position Control Expansion Function Selections	0000h to 0001h	-	0000h	All	After restart	Setup	page 8-77
	n.□□□X	Backlash Compensation Direction							
		0	Compensate forward references.						
		1	Compensate reverse references.						
	n.□□X□	Reserved parameter (Do not change.)							
	n.□X□□	Reserved parameter (Do not change.)							
n.X□□□	Reserved parameter (Do not change.)								
Pn231	4	Backlash Compensation	-500,000 to 500,000	0.1 reference units	0	All	Immediately	Setup	page 8-77
Pn233	2	Backlash Compensation Time Constant	0 to 65,535	0.01 ms	0	All	Immediately	Setup	page 8-77
Pn282	4	Linear Encoder Scale Pitch	0 to 6,553,600	0.01 μm	0	Linear	After restart	Setup	page 5-17
Pn304	2	Jogging Speed	0 to 10,000	Rotary: 1 min <sup>-1</sup> Direct Drive: 0.1 min <sup>-1</sup>	500	Rotary	Immediately	Setup	page 7-7
Pn305	2	Soft Start Acceleration Time	0 to 10,000	1 ms	0	All	Immediately	Setup	*1
Pn306	2	Soft Start Deceleration Time	0 to 10,000	1 ms	0	All	Immediately	Setup	*1
Pn308	2	Speed Feedback Filter Time Constant	0 to 65,535	0.01 ms	0	All	Immediately	Setup	page 8-88
Pn30A	2	Deceleration Time for Servo OFF and Forced Stops	0 to 10,000	1 ms	0	All	Immediately	Setup	page 5-30
Pn30C	2	Speed Feedforward Average Movement Time	0 to 5,100	0.1 ms	0	All	Immediately	Setup	-
Pn310	2	Vibration Detection Selections	0000h to 0002h	-	0000h	All	Immediately	Setup	page 6-37
	n.□□□X	Vibration Detection Selection							
		0	Do not detect vibration.						
		1	Output a warning (A.911) if vibration is detected.						
	2	Output an alarm (A.520) if vibration is detected.							
	n.□□X□	Reserved parameter (Do not change.)							
n.□X□□	Reserved parameter (Do not change.)								
n.X□□□	Reserved parameter (Do not change.)								
Pn311	2	Vibration Detection Sensitivity	50 to 500	1%	100	All	Immediately	Tuning	page 6-37
Pn312	2	Vibration Detection Level	0 to 5,000	1 min <sup>-1</sup>	50	Rotary	Immediately	Tuning	page 6-37
Pn316	2	Maximum Motor Speed	0 to 65,535	1 min <sup>-1</sup>	10000	Rotary	After restart	Setup	page 6-20
Pn324	2	Moment of Inertia Calculation Starting Level	0 to 20,000	1%	300	All	Immediately	Setup	page 8-31
Pn383	2	Jogging Speed	0 to 10,000	1 mm/s	50	Linear	Immediately	Setup	page 7-7

Continued on next page.

11.1 List of Servo Parameters

11.1.2 List of Servo Parameters

Continued from previous page.

Parameter No.	Size	Name	Setting Range	Setting Unit	Default Setting	Applicable Motors	When Enabled	Classification	Reference
Pn384	2	Vibration Detection Level	0 to 5,000	1 mm/s	10	Linear	Immediately	Tuning	page 6-37
Pn385	2	Maximum Motor Speed	1 to 100	100 mm/s	50	Linear	After restart	Setup	page 6-20
Pn401	2	First Stage First Torque Reference Filter Time Constant	0 to 65,535	0.01 ms	100	All	Immediately	Tuning	page 8-85
Pn402	2	Forward Torque Limit	0 to 800	1%*2	800	Rotary	Immediately	Setup	page 6-22
Pn403	2	Reverse Torque Limit	0 to 800	1%*2	800	Rotary	Immediately	Setup	page 6-22
Pn404	2	Forward External Torque Limit	0 to 800	1%*2	100	All	Immediately	Setup	page 6-23
Pn405	2	Reverse External Torque Limit	0 to 800	1%*2	100	All	Immediately	Setup	page 6-23
Pn406	2	Emergency Stop Torque	0 to 800	1%*2	800	All	Immediately	Setup	page 5-30
Pn407	2	Speed Limit during Torque Control	0 to 10,000	1 min <sup>-1</sup>	10000	Rotary	Immediately	Setup	page 6-16
Pn408	2	Torque-Related Function Selections	0000h to 1111h	-	0000h	All	-	Setup	-
	n.□□□X	Notch Filter Selection 1						When Enabled	Reference
		0	Disable first stage notch filter.					Immediately	page 8-85
		1	Enable first stage notch filter.						
	n.□□X□	Speed Limit Selection						When Enabled	Reference
		0	Use the smaller of the maximum motor speed and the setting of Pn407 as the speed limit.					After restart	page 6-16
			Use the smaller of the maximum motor speed and the setting of Pn480 as the speed limit.						
		1	Use the smaller of the overspeed alarm detection speed and the setting of Pn407 as the speed limit.						
	Use the smaller of the overspeed alarm detection speed and the setting of Pn480 as the speed limit.								
	n.□X□□	Notch Filter Selection 2						When Enabled	Reference
0		Disable second stage notch filter.					Immediately	page 8-85	
1		Enable second stage notch filter.							
n.X□□□	Friction Compensation Function Selection						When Enabled	Reference	
	0	Disable friction compensation.					Immediately	page 8-72	
	1	Enable friction compensation.							
Pn409	2	First Stage Notch Filter Frequency	50 to 5,000	1 Hz	5000	All	Immediately	Tuning	page 8-85
Pn40A	2	First Stage Notch Filter Q Value	50 to 1,000	0.01	70	All	Immediately	Tuning	page 8-85
Pn40B	2	First Stage Notch Filter Depth	0 to 1,000	0.001	0	All	Immediately	Tuning	page 8-85
Pn40C	2	Second Stage Notch Filter Frequency	50 to 5,000	1 Hz	5000	All	Immediately	Tuning	page 8-85
Pn40D	2	Second Stage Notch Filter Q Value	50 to 1,000	0.01	70	All	Immediately	Tuning	page 8-85
Pn40E	2	Second Stage Notch Filter Depth	0 to 1,000	0.001	0	All	Immediately	Tuning	page 8-85
Pn40F	2	Second Stage Second Torque Reference Filter Frequency	100 to 5,000	1 Hz	5000	All	Immediately	Tuning	page 8-85

Continued on next page.

Continued from previous page.

Parameter No.	Size	Name	Setting Range	Setting Unit	Default Setting	Applicable Motors	When Enabled	Classification	Reference	
Pn410	2	Second Stage Second Notch Filter Q Value	50 to 100	0.01	50	All	Immediately	Tuning	page 8-85	
Pn412	2	First Stage Second Torque Reference Filter Time Constant	0 to 65,535	0.01 ms	100	All	Immediately	Tuning	page 8-68	
Pn416	2	Torque-Related Function Selections 2	0000h to 1111h	-	0000h	All	Immediately	Setup	page 8-87	
	n.□□□X		<b>Notch Filter Selection 3</b>							
			0	Disable third stage notch filter.						
			1	Enable third stage notch filter.						
	n.□□X□		<b>Notch Filter Selection 4</b>							
			0	Disable fourth stage notch filter.						
			1	Enable fourth stage notch filter.						
	n.□X□□		<b>Notch Filter Selection 5</b>							
			0	Disable fifth stage notch filter.						
			1	Enable fifth stage notch filter.						
n.X□□□		Reserved parameter (Do not change.)								
Pn417	2	Third Stage Notch Filter Frequency	50 to 5,000	1 Hz	5000	All	Immediately	Tuning	page 8-87	
Pn418	2	Third Stage Notch Filter Q Value	50 to 1,000	0.01	70	All	Immediately	Tuning	page 8-87	
Pn419	2	Third Stage Notch Filter Depth	0 to 1,000	0.001	0	All	Immediately	Tuning	page 8-87	
Pn41A	2	Fourth Stage Notch Filter Frequency	50 to 5,000	1 Hz	5000	All	Immediately	Tuning	page 8-87	
Pn41B	2	Fourth Stage Notch Filter Q Value	50 to 1,000	0.01	70	All	Immediately	Tuning	page 8-87	
Pn41C	2	Fourth Stage Notch Filter Depth	0 to 1,000	0.001	0	All	Immediately	Tuning	page 8-87	
Pn41D	2	Fifth Stage Notch Filter Frequency	50 to 5,000	1 Hz	5000	All	Immediately	Tuning	page 8-87	
Pn41E	2	Fifth Stage Notch Filter Q Value	50 to 1,000	0.01	70	All	Immediately	Tuning	page 8-87	
Pn41F	2	Fifth Stage Notch Filter Depth	0 to 1,000	0.001	0	All	Immediately	Tuning	page 8-86	
Pn423	2	Speed Ripple Compensation Selections	0000h to 1111h	-	0000h	Rotary	-	Setup	page 8-66	
	n.□□□X		<b>Speed Ripple Compensation Function Selection</b>						<b>When Enabled</b>	
			0	Disable speed ripple compensation.						Immediately
			1	Enable speed ripple compensation.						
	n.□□X□		<b>Speed Ripple Compensation Information Disagreement Warning Detection Selection</b>						<b>When Enabled</b>	
			0	Detect A.942 alarms.						After restart
			1	Do not detect A.942 alarms.						
	n.□X□□		<b>Speed Ripple Compensation Enable Condition Selection</b>						<b>When Enabled</b>	
			0	Speed reference						After restart
			1	Motor speed						
n.X□□□		Reserved parameter (Do not change.)								

Continued on next page.

11.1 List of Servo Parameters

11.1.2 List of Servo Parameters

Continued from previous page.

Parameter No.	Size	Name	Setting Range	Setting Unit	Default Setting	Applicable Motors	When Enabled	Classification	Reference			
Pn424	2	Torque Limit at Main Circuit Voltage Drop	0 to 100	1%*2	50	All	Immediately	Setup	page 6-19			
Pn425	2	Release Time for Torque Limit at Main Circuit Voltage Drop	0 to 1,000	1 ms	100	All	Immediately	Setup	page 6-19			
Pn426	2	Torque Feedforward Average Movement Time	0 to 5,100	0.1 ms	0	All	Immediately	Setup	-			
Pn427	2	Speed Ripple Compensation Enable Speed	0 to 10,000	1 min <sup>-1</sup>	0	Rotary Servomotor	Immediately	Tuning	page 8-66			
Pn456	2	Sweep Torque Reference Amplitude	1 to 800	1%	15	All	Immediately	Tuning	page 8-100			
Pn460	2	Notch Filter Adjustment Selections 1		0000h to 0101h	-	0101h	All	Immediately	Tuning	page 8-15, page 8-32		
		n.□□□X	Notch Filter Adjustment Selection 1									
			0	Do not adjust the first stage notch filter automatically during execution of autotuning without a host reference, autotuning with a host reference, and custom tuning.								
		1	Adjust the first stage notch filter automatically during execution of autotuning without a host reference, autotuning with a host reference, and custom tuning.									
		n.□□X□	Reserved parameter (Do not change.)									
		n.□X□□	Notch Filter Adjustment Selection 2									
			0	Do not adjust the second stage notch filter automatically when the tuning-less function is enabled or during execution of autotuning without a host reference, autotuning with a host reference, and custom tuning.								
1	Adjust the second stage notch filter automatically when the tuning-less function is enabled or during execution of autotuning without a host reference, autotuning with a host reference, and custom tuning.											
n.X□□□	Reserved parameter (Do not change.)											
Pn475	2	Gravity Compensation-Related Selections		0000h to 0001h	-	0000h	All	After restart	Setup	page 8-74		
		n.□□□X	Gravity Compensation Selection									
			0	Disable gravity compensation.								
		1	Enable gravity compensation.									
		n.□□X□	Reserved parameter (Do not change.)									
		n.□X□□	Reserved parameter (Do not change.)									
n.X□□□	Reserved parameter (Do not change.)											
Pn476	2	Gravity Compensation Torque	-1,000 to 1,000	0.1%	0	All	Immediately	Tuning	page 8-74			
Pn480	2	Speed Limit during Force Control	0 to 10,000	1 mm/s	10000	Linear	Immediately	Setup	page 6-16			
Pn481	2	Polarity Detection Speed Loop Gain	10 to 20,000	0.1 Hz	400	Linear	Immediately	Tuning	-			
Pn482	2	Polarity Detection Speed Loop Integral Time Constant	15 to 51,200	0.01 ms	3000	Linear	Immediately	Tuning	-			
Pn483	2	Forward Force Limit	0 to 800	1%*2	30	Linear	Immediately	Setup	page 6-22			
Pn484	2	Reverse Force Limit	0 to 800	1%*2	30	Linear	Immediately	Setup	page 6-22			
Pn485	2	Polarity Detection Reference Speed	0 to 100	1 mm/s	20	Linear	Immediately	Tuning	-			

Continued on next page.

Continued from previous page.

Parameter No.	Size	Name	Setting Range	Setting Unit	Default Setting	Applicable Motors	When Enabled	Classification	Reference
Pn486	2	Polarity Detection Reference Acceleration/Deceleration Time	0 to 100	1 ms	25	Linear	Immediately	Tuning	–
Pn487	2	Polarity Detection Constant Speed Time	0 to 300	1 ms	0	Linear	Immediately	Tuning	–
Pn488	2	Polarity Detection Reference Waiting Time	50 to 500	1 ms	100	Linear	Immediately	Tuning	–
Pn48E	2	Polarity Detection Range	1 to 65,535	1 mm	10	Linear	Immediately	Tuning	–
Pn490	2	Polarity Detection Load Level	0 to 20,000	1%	100	Linear	Immediately	Tuning	–
Pn495	2	Polarity Detection Confirmation Force Reference	0 to 200	1%	100	Linear	Immediately	Tuning	–
Pn498	2	Polarity Detection Allowable Error Range	0 to 30	1 deg	10	Linear	Immediately	Tuning	–
Pn49F	2	Speed Ripple Compensation Enable Speed	0 to 10,000	1 mm/s	0	Linear	Immediately	Tuning	page 8-66
Pn502	2	Rotation Detection Level	1 to 10,000	1 min <sup>-1</sup>	20	Rotary	Immediately	Setup	page 6-11
Pn503	2	Speed Coincidence Detection Signal Output Width	0 to 100	1 min <sup>-1</sup>	10	Rotary	Immediately	Setup	page 6-12
Pn506	2	Brake Reference-Servo OFF Delay Time	0 to 50	10 ms	0	All	Immediately	Setup	page 5-33
Pn507	2	Brake Reference Output Speed Level	0 to 10,000	1 min <sup>-1</sup>	100	Rotary	Immediately	Setup	page 5-33
Pn508	2	Servo OFF-Brake Command Waiting Time	10 to 100	10 ms	50	All	Immediately	Setup	page 5-33
Pn509 All Axes	2	Momentary Power Interruption Hold Time	20 to 50,000	1 ms	20	All	Immediately	Setup	page 6-17

Continued on next page.

11.1 List of Servo Parameters

11.1.2 List of Servo Parameters

Continued from previous page.

Parameter No.	Size	Name	Setting Range	Setting Unit	Default Setting	Applicable Motors	When Enabled	Classification	Reference	
Pn50A	2	Input Signal Selections	0000h to FFF2h	–	0881h	All	After restart	Setup	–	
	n.□□□X	I/O Signal Allocation Mode							Reference	
		0	Reserved setting (Do not use.)							page 6-3
		1	Use $\Sigma$ -7S-compatible I/O signal allocations (Pn50A to Pn517).							
		2	Use multi-axis I/O signal allocations (Pn590 to Pn5BC).							
	n.□□X□	Reserved parameter (Do not change.)								
	n.□X□□	Reserved parameter (Do not change.)								
	n.X□□□	P-OT (Forward Drive Prohibit) Signal Allocation							Reference	
		0	Axis A: Enable forward drive when CN1-3 input signal is ON (closed). Axis B: Enable forward drive when CN1-9 input signal is ON (closed).							page 5-29
		1	Axis A: Enable forward drive when CN1-4 input signal is ON (closed). Axis B: Enable forward drive when CN1-10 input signal is ON (closed).							
		2	Axis A: Enable forward drive when CN1-5 input signal is ON (closed). Axis B: Enable forward drive when CN1-11 input signal is ON (closed).							
		3	Axis A: Enable forward drive when CN1-6 input signal is ON (closed). Axis B: Enable forward drive when CN1-12 input signal is ON (closed).							
		4	Axis A: Enable forward drive when CN1-7 input signal is ON (closed). Axis B: Enable forward drive when CN1-13 input signal is ON (closed).							
		5	Axis A: Enable forward drive when CN1-8 input signal is ON (closed). Axis B: Enable forward drive when CN1-14 input signal is ON (closed).							
		6	Reserved setting (Do not use.)							
		7	Set the signal to always prohibit forward drive.							
		8	Set the signal to always enable forward drive.							
		9	Axis A: Enable forward drive when CN1-3 input signal is OFF (open). Axis B: Enable forward drive when CN1-9 input signal is OFF (open).							
		A	Axis A: Enable forward drive when CN1-4 input signal is OFF (open). Axis B: Enable forward drive when CN1-10 input signal is OFF (open).							
		B	Axis A: Enable forward drive when CN1-5 input signal is OFF (open). Axis B: Enable forward drive when CN1-11 input signal is OFF (open).							
	C	Axis A: Enable forward drive when CN1-6 input signal is OFF (open). Axis B: Enable forward drive when CN1-12 input signal is OFF (open).								
	D	Axis A: Enable forward drive when CN1-7 input signal is OFF (open). Axis B: Enable forward drive when CN1-13 input signal is OFF (open).								
	E	Axis A: Enable forward drive when CN1-8 input signal is OFF (open). Axis B: Enable forward drive when CN1-14 input signal is OFF (open).								
	F	Reserved setting (Do not use.)								

Continued on next page.

Continued from previous page.

Parameter No.	Size	Name	Setting Range	Setting Unit	Default Setting	Applicable Motors	When Enabled	Classification	Reference		
Pn50B	2	Input Signal Selections	0000h to FFFFh	-	8881h	All	After restart	Setup	-		
	n.□□□X	<b>N-OT (Reverse Drive Prohibit) Signal Allocation</b>								<b>Reference</b>	
		0	Axis A: Enable reverse drive when CN1-3 input signal is ON (closed). Axis B: Enable reverse drive when CN1-9 input signal is ON (closed).								page 5-29
		1	Axis A: Enable reverse drive when CN1-4 input signal is ON (closed). Axis B: Enable reverse drive when CN1-10 input signal is ON (closed).								
		2	Axis A: Enable reverse drive when CN1-5 input signal is ON (closed). Axis B: Enable reverse drive when CN1-11 input signal is ON (closed).								
		3	Axis A: Enable reverse drive when CN1-6 input signal is ON (closed). Axis B: Enable reverse drive when CN1-12 input signal is ON (closed).								
		4	Axis A: Enable reverse drive when CN1-7 input signal is ON (closed). Axis B: Enable reverse drive when CN1-13 input signal is ON (closed).								
		5	Axis A: Enable reverse drive when CN1-8 input signal is ON (closed). Axis B: Enable reverse drive when CN1-14 input signal is ON (closed).								
		6	Reserved setting (Do not use.)								
		7	Set the signal to always prohibit reverse drive.								
		8	Set the signal to always enable reverse drive.								
		9	Axis A: Enable reverse drive when CN1-3 input signal is OFF (open). Axis B: Enable reverse drive when CN1-9 input signal is OFF (open).								
		A	Axis A: Enable reverse drive when CN1-4 input signal is OFF (open). Axis B: Enable reverse drive when CN1-10 input signal is OFF (open).								
		B	Axis A: Enable reverse drive when CN1-5 input signal is OFF (open). Axis B: Enable reverse drive when CN1-11 input signal is OFF (open).								
		C	Axis A: Enable reverse drive when CN1-6 input signal is OFF (open). Axis B: Enable reverse drive when CN1-12 input signal is OFF (open).								
D	Axis A: Enable reverse drive when CN1-7 input signal is OFF (open). Axis B: Enable reverse drive when CN1-13 input signal is OFF (open).										
E	Axis A: Enable reverse drive when CN1-8 input signal is OFF (open). Axis B: Enable reverse drive when CN1-14 input signal is OFF (open).										
F	Reserved setting (Do not use.)										
n.□□□□	Reserved parameter (Do not change.)										

Continued on next page.

Continued on next page.



11.1 List of Servo Parameters

11.1.2 List of Servo Parameters

Continued from previous page.

Parameter No.	Size	Name	Setting Range	Setting Unit	Default Setting	Applicable Motors	When Enabled	Classification	Reference	
Pn50B	n.X□□□	Continued from previous page.								
		/P-CL (Forward External Torque Limit Input) Signal Allocation								Reference
		0	Axis A: Active when CN1-3 input signal is ON (closed). Axis B: Active when CN1-9 input signal is ON (closed).							page 6-23
		1	Axis A: Active when CN1-4 input signal is ON (closed). Axis B: Active when CN1-10 input signal is ON (closed).							
		2	Axis A: Active when CN1-5 input signal is ON (closed). Axis B: Active when CN1-11 input signal is ON (closed).							
		3	Axis A: Active when CN1-6 input signal is ON (closed). Axis B: Active when CN1-12 input signal is ON (closed).							
		4	Axis A: Active when CN1-7 input signal is ON (closed). Axis B: Active when CN1-13 input signal is ON (closed).							
		5	Axis A: Active when CN1-8 input signal is ON (closed). Axis B: Active when CN1-14 input signal is ON (closed).							
		6	Reserved setting (Do not use.)							
		7	The signal is always active.							
		8	The signal is always inactive.							
		9	Axis A: Active when CN1-3 input signal is OFF (open). Axis B: Active when CN1-9 input signal is OFF (open).							
		A	Axis A: Active when CN1-4 input signal is OFF (open). Axis B: Active when CN1-10 input signal is OFF (open).							
		B	Axis A: Active when CN1-5 input signal is OFF (open). Axis B: Active when CN1-11 input signal is OFF (open).							
		C	Axis A: Active when CN1-6 input signal is OFF (open). Axis B: Active when CN1-12 input signal is OFF (open).							
		D	Axis A: Active when CN1-7 input signal is OFF (open). Axis B: Active when CN1-13 input signal is OFF (open).							
		E	Axis A: Active when CN1-8 input signal is OFF (open). Axis B: Active when CN1-14 input signal is OFF (open).							
		F	Reserved setting (Do not use.)							
		/N-CL (Reverse External Torque Limit Input) Signal Allocation								Reference
		0 to F	The allocations are the same as the /P-CL (Forward External Torque Limit Input) signal allocations.							page 6-23

Continued on next page.

Continued from previous page.

Parameter No.	Size	Name	Setting Range	Setting Unit	Default Setting	Applicable Motors	When Enabled	Classification	Reference		
Pn50E	2	Output Signal Selections 1	0000h to 6666h	–	0000h	All	After restart	Setup	–		
	n.□□□X	<b>/COIN (Positioning Completion Output) Signal Allocation</b>				<b>Reference</b>					
		0	Disabled (the above signal output is not used).				page 6-13				
		1	Axis A: Output the signal from the CN1-23 or CN1-24 output terminal. Axis B: Output the signal from the CN1-25 or CN1-26 output terminal.								
		2	Axis A: Output the signal from the CN1-27 or CN1-28 output terminal. Axis B: Output the signal from the CN1-29 or CN1-30 output terminal.								
	3 to 6	Reserved setting (Do not use.)									
	n.□□X□	<b>/V-CMP (Speed Coincidence Detection Output) Signal Allocation</b>				<b>Reference</b>					
		0 to 6	The allocations are the same as the /COIN (Positioning Completion) signal allocations.				page 6-12				
	n.□X□□	<b>/TGON (Rotation Detection Output) Signal Allocation</b>				<b>Reference</b>					
		0 to 6	The allocations are the same as the /COIN (Positioning Completion) signal allocations.				page 6-11				
	n.X□□□	<b>/S-RDY (Servo Ready) Signal Allocation</b>				<b>Reference</b>					
		0 to 6	The allocations are the same as the /COIN (Positioning Completion) signal allocations.				page 6-12				
	Pn50F	2	Output Signal Selections 2	0000h to 6666h	–	0100h	All	After restart	Setup	–	
		n.□□□X	<b>/CLT (Torque Limit Detection Output) Signal Allocation</b>				<b>Reference</b>				
			0	Disabled (the above signal output is not used).				page 6-26			
			1	Axis A: Output the signal from the CN1-23 or CN1-24 output terminal. Axis B: Output the signal from the CN1-25 or CN1-26 output terminal.							
2			Axis A: Output the signal from the CN1-27 or CN1-28 output terminal. Axis B: Output the signal from the CN1-29 or CN1-30 output terminal.								
3 to 6		Reserved setting (Do not use.)									
n.□□X□		<b>/VLT (Speed Limit Detection) Signal Allocation</b>				<b>Reference</b>					
		0 to 6	The allocations are the same as the /CLT (Torque Limit Detection Output) signal allocations.				page 6-15				
n.□X□□		<b>/BK (Brake Output) Signal Allocation</b>				<b>Reference</b>					
		0 to 6	The allocations are the same as the /CLT (Torque Limit Detection Output) signal allocations.				page 5-34				
n.X□□□		<b>/WARN (Warning Output) Signal Allocation</b>				<b>Reference</b>					
		0 to 6	The allocations are the same as the /CLT (Torque Limit Detection Output) signal allocations.				page 6-10				

Continued on next page.

11.1 List of Servo Parameters

11.1.2 List of Servo Parameters

Continued from previous page.

Parameter No.	Size	Name	Setting Range	Setting Unit	Default Setting	Applicable Motors	When Enabled	Classification	Reference	
Pn510	2	Output Signal Selections 3	0000h to 0666h	–	0000h	All	After restart	Setup	–	
		/NEAR (Near Output) Signal Allocation							Reference	
		n.□□□X	0	Disabled (the above signal output is not used).						page 6-14
			1	Axis A: Output the signal from the CN1-23 or CN1-24 output terminal. Axis B: Output the signal from the CN1-25 or CN1-26 output terminal.						
			2	Axis A: Output the signal from the CN1-27 or CN1-28 output terminal. Axis B: Output the signal from the CN1-29 or CN1-30 output terminal.						
			3 to 6	Reserved setting (Do not use.)						
		n.□□X□	Reserved parameter (Do not change.)							
		n.□X□□	Reserved parameter (Do not change.)							
		n.X□□□	Reserved parameter (Do not change.)							

Continued on next page.

Continued from previous page.

Parameter No.	Size	Name	Setting Range	Setting Unit	Default Setting	Applicable Motors	When Enabled	Classification	Reference	
Pn511	2	Input Signal Selections	0000h to FFFFh	-	5432h	All	After restart	Setup	page 6-3	
			<b>/DEC (Origin Return Deceleration Switch Input) Signal Allocation</b>							
		n.□□□X	0	Axis A: Active when CN1-3 input signal is ON (closed). Axis B: Active when CN1-9 input signal is ON (closed).						
			1	Axis A: Active when CN1-4 input signal is ON (closed). Axis B: Active when CN1-10 input signal is ON (closed).						
			2	Axis A: Active when CN1-5 input signal is ON (closed). Axis B: Active when CN1-11 input signal is ON (closed).						
			3	Axis A: Active when CN1-6 input signal is ON (closed). Axis B: Active when CN1-12 input signal is ON (closed).						
			4	Axis A: Active when CN1-7 input signal is ON (closed). Axis B: Active when CN1-13 input signal is ON (closed).						
			5	Axis A: Active when CN1-8 input signal is ON (closed). Axis B: Active when CN1-14 input signal is ON (closed).						
			6	Reserved setting (Do not use.)						
			7	The signal is always active.						
			8	The signal is always inactive.						
			9	Axis A: Active when CN1-3 input signal is OFF (open). Axis B: Active when CN1-9 input signal is OFF (open).						
			A	Axis A: Active when CN1-4 input signal is OFF (open). Axis B: Active when CN1-10 input signal is OFF (open).						
			B	Axis A: Active when CN1-5 input signal is OFF (open). Axis B: Active when CN1-11 input signal is OFF (open).						
			C	Axis A: Active when CN1-6 input signal is OFF (open). Axis B: Active when CN1-12 input signal is OFF (open).						
		D	Axis A: Active when CN1-7 input signal is OFF (open). Axis B: Active when CN1-13 input signal is OFF (open).							
		E	Axis A: Active when CN1-8 input signal is OFF (open). Axis B: Active when CN1-14 input signal is OFF (open).							
		F	Reserved setting (Do not use.)							
		<b>/EXT1 (External Latch Input 1) Signal Allocation</b>								
		n.□□□□	0 to 2	The signal is always inactive.						
			3	Axis A: Active when CN1-6 input signal is ON (closed). Axis B: Active when CN1-12 input signal is ON (closed).						
			4	Axis A: Active when CN1-7 input signal is ON (closed). Axis B: Active when CN1-13 input signal is ON (closed).						
			5	Axis A: Active when CN1-8 input signal is ON (closed). Axis B: Active when CN1-14 input signal is ON (closed).						
			6 to B	The signal is always inactive.						
			C	Axis A: Active when CN1-6 input signal is OFF (open). Axis B: Active when CN1-12 input signal is OFF (open).						
			D	Axis A: Active when CN1-7 input signal is OFF (open). Axis B: Active when CN1-13 input signal is OFF (open).						
			E	Axis A: Active when CN1-8 input signal is OFF (open). Axis B: Active when CN1-14 input signal is OFF (open).						
			F	The signal is always inactive.						
		<b>/EXT2 (External Latch Input 2) Signal Allocation</b>								
		n.□□□□	0 to F	The allocations are the same as the /EXT1 (External Latch Input 1) signal allocations.						
		<b>/EXT3 (External Latch Input 3) Signal Allocation</b>								
		n.X□□□	0 to F	The allocations are the same as the /EXT1 (External Latch Input 1) signal allocations.						

Continued on next page.

11.1 List of Servo Parameters

11.1.2 List of Servo Parameters

Continued from previous page.

Parameter No.	Size	Name	Setting Range	Setting Unit	Default Setting	Applicable Motors	When Enabled	Classification	Reference	
Pn512	2	Output Signal Inverse Settings	0000h to 1111h	-	0000h	All	After restart	Setup	page 6-6	
	n.□□□X		Output Inversion for CN1-23, CN1-24, CN1-25, and CN1-26 Terminals (Axis A: CN1-23 and CN1-24, Axis B: CN1-25 and CN1-26)							
			0	The signal is not inverted.						
			1	The signal is inverted.						
	n.□□□□		Output Inversion for CN1-27, CN1-28, CN1-29, and CN1-30 Terminals (Axis A: CN1-27 and CN1-28, Axis B: CN1-29 and CN1-30)							
			0	The signal is not inverted.						
		1	The signal is inverted.							
n.□X□□		Reserved parameter (Do not change.)								
n.X□□□		Reserved parameter (Do not change.)								
Pn514	2	Output Signal Selections 4	0000h to 0666h	-	0000h	All	After restart	Setup	-	
	n.□□□X		Reserved parameter (Do not change.)							
	n.□□X□		Reserved parameter (Do not change.)							
	n.□X□□		/PM (Preventative Maintenance Output) Signal Allocation							Reference
			0	Disabled (the above signal output is not used).						page 9-16
			1	Axis A: Output the signal from the CN1-23 or CN1-24 output terminal. Axis B: Output the signal from the CN1-25 or CN1-26 output terminal.						
2			Axis A: Output the signal from the CN1-27 or CN1-28 output terminal. Axis B: Output the signal from the CN1-29 or CN1-30 output terminal.							
3 to 6	Reserved setting (Do not use.)									
n.X□□□		Reserved parameter (Do not change.)								

Continued on next page.

Continued from previous page.

Parameter No.	Size	Name	Setting Range	Setting Unit	Default Setting	Applicable Motors	When Enabled	Classification	Reference		
Pn516	2	Input Signal Selections 7	0000h to FFFFh	-	8888h	All	After restart	Setup	-		
	n.□□□X	<b>FSTP (Forced Stop Input) Signal Allocation</b>								<b>Reference</b>	
		0	Axis A: Enable drive when CN1-3 input signal is ON (closed). Axis B: Enable drive when CN1-9 input signal is ON (closed).								page 6-45
		1	Axis A: Enable drive when CN1-4 input signal is ON (closed). Axis B: Enable drive when CN1-10 input signal is ON (closed).								
		2	Axis A: Enable drive when CN1-5 input signal is ON (closed). Axis B: Enable drive when CN1-11 input signal is ON (closed).								
		3	Axis A: Enable drive when CN1-6 input signal is ON (closed). Axis B: Enable drive when CN1-12 input signal is ON (closed).								
		4	Axis A: Enable drive when CN1-7 input signal is ON (closed). Axis B: Enable drive when CN1-13 input signal is ON (closed).								
		5	Axis A: Enable drive when CN1-8 input signal is ON (closed). Axis B: Enable drive when CN1-14 input signal is ON (closed).								
		6	Reserved setting (Do not use.)								
		7	Set the signal to always prohibit drive (always force the motor to stop).								
		8	Set the signal to always enable drive (always disable forcing the motor to stop).								
		9	Axis A: Enable drive when CN1-3 input signal is OFF (open). Axis B: Enable drive when CN1-9 input signal is OFF (open).								
		A	Axis A: Enable drive when CN1-4 input signal is OFF (open). Axis B: Enable drive when CN1-10 input signal is OFF (open).								
		B	Axis A: Enable drive when CN1-5 input signal is OFF (open). Axis B: Enable drive when CN1-11 input signal is OFF (open).								
		C	Axis A: Enable drive when CN1-6 input signal is OFF (open). Axis B: Enable drive when CN1-12 input signal is OFF (open).								
		D	Axis A: Enable drive when CN1-7 input signal is OFF (open). Axis B: Enable drive when CN1-13 input signal is OFF (open).								
		E	Axis A: Enable drive when CN1-8 input signal is OFF (open). Axis B: Enable drive when CN1-14 input signal is OFF (open).								
		F	Reserved setting (Do not use.)								
	n.□□X□	Reserved parameter (Do not change.)									
	n.□X□□	Reserved parameter (Do not change.)									
n.X□□□	Reserved parameter (Do not change.)										
Pn51E	2	Position Deviation Overflow Warning Level	10 to 100	1%	100	All	Immediately	Setup	page 8-9		
Pn520	4	Position Deviation Overflow Alarm Level	1 to 1,073,741,823	1 reference unit	5242880	All	Immediately	Setup	page 8-8, page 8-91		
Pn522	4	Positioning Completed Width	0 to 1,073,741,824	1 reference unit	7	All	Immediately	Setup	page 6-13		
Pn524	4	Near Signal Width	1 to 1,073,741,824	1 reference unit	1073741824	All	Immediately	Setup	page 6-15		
Pn526	4	Position Deviation Overflow Alarm Level at Servo ON	1 to 1,073,741,823	1 reference unit	5242880	All	Immediately	Setup	page 8-10		
Pn528	2	Position Deviation Overflow Warning Level at Servo ON	10 to 100	1%	100	All	Immediately	Setup	page 8-10		
Pn529	2	Speed Limit Level at Servo ON	0 to 10,000	1 min <sup>-1</sup>	10000	Rotary	Immediately	Setup	page 8-10		
Pn52B	2	Overload Warning Level	1 to 100	1%	20	All	Immediately	Setup	page 5-41		

Continued on next page.

11.1 List of Servo Parameters

11.1.2 List of Servo Parameters

Continued from previous page.

Parameter No.	Size	Name	Setting Range	Setting Unit	Default Setting	Applicable Motors	When Enabled	Classification	Reference	
Pn52C	2	Base Current Derating at Motor Overload Detection	10 to 100	1%	100	All	After restart	Setup	page 5-42	
Pn530	2	Program Jogging-Related Selections	0000h to 0005h	–	0000h	All	Immediately	Setup	page 7-14	
			<b>Program Jogging Operation Pattern</b>							
			0	(Waiting time in Pn535 → Forward by travel distance in Pn531) × Number of movements in Pn536						
			1	(Waiting time in Pn535 → Reverse by travel distance in Pn531) × Number of movements in Pn536						
			2	(Waiting time in Pn535 → Forward by travel distance in Pn531) × Number of movements in Pn536 (Waiting time in Pn535 → Reverse by travel distance in Pn531) × Number of movements in Pn536						
			3	(Waiting time in Pn535 → Reverse by travel distance in Pn531) × Number of movements in Pn536 (Waiting time in Pn535 → Forward by travel distance in Pn531) × Number of movements in Pn536						
			4	(Waiting time in Pn535 → Forward by travel distance in Pn531 → Waiting time in Pn535 → Reverse by travel distance in Pn531) × Number of movements in Pn536						
			5	(Waiting time in Pn535 → Reverse by travel distance in Pn531 → Waiting time in Pn535 → Forward by travel distance in Pn531) × Number of movements in Pn536						
			n.□□□□	Reserved parameter (Do not change.)						
			n.□X□□	Reserved parameter (Do not change.)						
		n.X□□□	Reserved parameter (Do not change.)							
Pn531	4	Program Jogging Travel Distance	1 to 1,073,741,824	1 reference unit	32768	All	Immediately	Setup	page 7-14	
Pn533	2	Program Jogging Movement Speed	1 to 10,000	Rotary: 1 min <sup>-1</sup> Direct Drive: 0.1 min <sup>-1</sup>	500	Rotary	Immediately	Setup	page 7-14	
Pn534	2	Program Jogging Acceleration/Deceleration Time	2 to 10,000	1 ms	100	All	Immediately	Setup	page 7-14	
Pn535	2	Program Jogging Waiting Time	0 to 10,000	1 ms	100	All	Immediately	Setup	page 7-14	
Pn536	2	Program Jogging Number of Movements	0 to 1,000	Times	1	All	Immediately	Setup	page 7-14	
Pn550 All Axes	2	Analog Monitor 1 Offset Voltage	-10,000 to 10,000	0.1 V	0	All	Immediately	Setup	page 9-10	
Pn551 All Axes	2	Analog Monitor 2 Offset Voltage	-10,000 to 10,000	0.1 V	0	All	Immediately	Setup	page 9-10	
Pn552 All Axes	2	Analog Monitor 1 Magnification	-10,000 to 10,000	× 0.01	100	All	Immediately	Setup	page 9-10	
Pn553 All Axes	2	Analog Monitor 2 Magnification	-10,000 to 10,000	× 0.01	100	All	Immediately	Setup	page 9-10	
Pn55A All Axes	2	Power Consumption Monitor Unit Time	1 to 1,440	1 min	1	All	Immediately	Setup	–	
Pn560	2	Residual Vibration Detection Width	1 to 3,000	0.1%	400	All	Immediately	Setup	page 8-58	

Continued on next page.

Continued from previous page.

Parameter No.	Size	Name	Setting Range	Setting Unit	Default Setting	Applicable Motors	When Enabled	Classification	Reference																																																																																																																									
Pn561	2	Overshoot Detection Level	0 to 100	1%	100	All	Immediately	Setup	page 8-31, page 8-41																																																																																																																									
Pn56A	2	Output Signal Reference Method Selections 1	0000h to 1111h	-	0000h	All	After restart	Setup	page 6-8																																																																																																																									
		<table border="1"> <tr> <td colspan="2"><b>n.□□□X</b></td> <td colspan="8"><b>SO1 Output Signal Reference Method Selection</b></td> </tr> <tr> <td colspan="2"></td> <td>0</td> <td colspan="7">Output parameter-assigned SO1 signal.</td> </tr> <tr> <td colspan="2"></td> <td>1</td> <td colspan="7">Output OR of parameter-assigned SO1 signal and signal set by SVCMD_IO.</td> </tr> <tr> <td colspan="2"><b>n.□□X□</b></td> <td colspan="8"><b>SO2 Output Signal Reference Method Selection</b></td> </tr> <tr> <td colspan="2"></td> <td>0</td> <td colspan="7">Output parameter-assigned SO2 signal.</td> </tr> <tr> <td colspan="2"></td> <td>1</td> <td colspan="7">Output OR of parameter-assigned SO2 signal and signal set by SVCMD_IO.</td> </tr> <tr> <td colspan="2"><b>n.□X□□</b></td> <td colspan="8"><b>SO3 Output Signal Reference Method Selection</b></td> </tr> <tr> <td colspan="2"></td> <td>0</td> <td colspan="7">Output parameter-assigned SO3 signal.</td> </tr> <tr> <td colspan="2"></td> <td>1</td> <td colspan="7">Output OR of parameter-assigned SO3 signal and signal set by SVCMD_IO.</td> </tr> <tr> <td colspan="2"><b>n.X□□□</b></td> <td colspan="8"><b>SO4 Output Signal Reference Method Selection</b></td> </tr> <tr> <td colspan="2"></td> <td>0</td> <td colspan="7">Output parameter-assigned SO4 signal.</td> </tr> <tr> <td colspan="2"></td> <td>1</td> <td colspan="7">Output OR of parameter-assigned SO4 signal and signal set by SVCMD_IO.</td> </tr> </table>									<b>n.□□□X</b>		<b>SO1 Output Signal Reference Method Selection</b>										0	Output parameter-assigned SO1 signal.									1	Output OR of parameter-assigned SO1 signal and signal set by SVCMD_IO.							<b>n.□□X□</b>		<b>SO2 Output Signal Reference Method Selection</b>										0	Output parameter-assigned SO2 signal.									1	Output OR of parameter-assigned SO2 signal and signal set by SVCMD_IO.							<b>n.□X□□</b>		<b>SO3 Output Signal Reference Method Selection</b>										0	Output parameter-assigned SO3 signal.									1	Output OR of parameter-assigned SO3 signal and signal set by SVCMD_IO.							<b>n.X□□□</b>		<b>SO4 Output Signal Reference Method Selection</b>										0	Output parameter-assigned SO4 signal.									1	Output OR of parameter-assigned SO4 signal and signal set by SVCMD_IO.						
		<b>n.□□□X</b>		<b>SO1 Output Signal Reference Method Selection</b>																																																																																																																														
				0	Output parameter-assigned SO1 signal.																																																																																																																													
				1	Output OR of parameter-assigned SO1 signal and signal set by SVCMD_IO.																																																																																																																													
		<b>n.□□X□</b>		<b>SO2 Output Signal Reference Method Selection</b>																																																																																																																														
				0	Output parameter-assigned SO2 signal.																																																																																																																													
				1	Output OR of parameter-assigned SO2 signal and signal set by SVCMD_IO.																																																																																																																													
		<b>n.□X□□</b>		<b>SO3 Output Signal Reference Method Selection</b>																																																																																																																														
				0	Output parameter-assigned SO3 signal.																																																																																																																													
				1	Output OR of parameter-assigned SO3 signal and signal set by SVCMD_IO.																																																																																																																													
		<b>n.X□□□</b>		<b>SO4 Output Signal Reference Method Selection</b>																																																																																																																														
				0	Output parameter-assigned SO4 signal.																																																																																																																													
				1	Output OR of parameter-assigned SO4 signal and signal set by SVCMD_IO.																																																																																																																													
		Pn56B	2	Output Signal Reference Method Selections 2	0000h to 00001h	-	0000h	All	After restart	Setup	page 6-8																																																																																																																							
				<table border="1"> <tr> <td colspan="2"><b>n.□□□X</b></td> <td colspan="8"><b>SO5 Output Signal Reference Method Selection</b></td> </tr> <tr> <td colspan="2"></td> <td>0</td> <td colspan="7">Output parameter-assigned SO5 signal.</td> </tr> <tr> <td colspan="2"></td> <td>1</td> <td colspan="7">Output OR of parameter-assigned SO5 signal and signal set by SVCMD_IO.</td> </tr> <tr> <td colspan="2"><b>n.□□X□</b></td> <td colspan="8">Reserved parameter (Do not change.)</td> </tr> <tr> <td colspan="2"><b>n.□X□□</b></td> <td colspan="8">Reserved parameter (Do not change.)</td> </tr> <tr> <td colspan="2"><b>n.X□□□</b></td> <td colspan="8">Reserved parameter (Do not change.)</td> </tr> </table>									<b>n.□□□X</b>		<b>SO5 Output Signal Reference Method Selection</b>										0	Output parameter-assigned SO5 signal.									1	Output OR of parameter-assigned SO5 signal and signal set by SVCMD_IO.							<b>n.□□X□</b>		Reserved parameter (Do not change.)								<b>n.□X□□</b>		Reserved parameter (Do not change.)								<b>n.X□□□</b>		Reserved parameter (Do not change.)																																																																	
				<b>n.□□□X</b>		<b>SO5 Output Signal Reference Method Selection</b>																																																																																																																												
						0	Output parameter-assigned SO5 signal.																																																																																																																											
						1	Output OR of parameter-assigned SO5 signal and signal set by SVCMD_IO.																																																																																																																											
				<b>n.□□X□</b>		Reserved parameter (Do not change.)																																																																																																																												
<b>n.□X□□</b>				Reserved parameter (Do not change.)																																																																																																																														
<b>n.X□□□</b>		Reserved parameter (Do not change.)																																																																																																																																
Pn581	2	Zero Speed Level	1 to 10,000	1 mm/s	20	Linear	Immediately	Setup	page 6-11																																																																																																																									
Pn582	2	Speed Coincidence Detection Signal Output Width	0 to 100	1 mm/s	10	Linear	Immediately	Setup	page 6-12																																																																																																																									
Pn583	2	Brake Reference Output Speed Level	0 to 10,000	1 mm/s	10	Linear	Immediately	Setup	page 5-33																																																																																																																									
Pn584	2	Speed Limit Level at Servo ON	0 to 10,000	1 mm/s	10000	Linear	Immediately	Setup	page 8-10																																																																																																																									
Pn585	2	Program Jogging Movement Speed	1 to 10,000	1 mm/s	50	Linear	Immediately	Setup	page 7-14																																																																																																																									
Pn586	2	Motor Running Cooling Ratio	0 to 100	1%/Max. speed	0	Linear	Immediately	Setup	-																																																																																																																									

Continued on next page.



11.1 List of Servo Parameters

11.1.2 List of Servo Parameters

Continued from previous page.

Parameter No.	Size	Name	Setting Range	Setting Unit	Default Setting	Applicable Motors	When Enabled	Classification	Reference		
Pn587	2	Polarity Detection Execution Selection for Absolute Linear Encoder	0000h to 0001h	-	0000h	Linear	Immediately	Setup	-		
	n.□□□X		<b>Polarity Detection Selection for Absolute Linear Encoder</b>								
			0	Do not detect polarity.							
			1	Detect polarity.							
	n.□□□□		Reserved parameter (Do not change.)								
	n.□X□□		Reserved parameter (Do not change.)								
Pn590	2	P-OT (Forward Drive Prohibit) Signal Allocation	0000h to 3019h	-	Axis A: 1003h, Axis B: 1009h	All	After restart	Setup	page 5-29, page 6-4		
	n.□XXX		<b>Allocated Pin Number</b>								
			003	Allocate the signal to CN1-3.							
			004	Allocate the signal to CN1-4.							
			005	Allocate the signal to CN1-5.							
			006	Allocate the signal to CN1-6.							
			007	Allocate the signal to CN1-7.							
			008	Allocate the signal to CN1-8.							
			009	Allocate the signal to CN1-9.							
			010	Allocate the signal to CN1-10.							
			011	Allocate the signal to CN1-11.							
			012	Allocate the signal to CN1-12.							
			013	Allocate the signal to CN1-13.							
			014	Allocate the signal to CN1-14.							
	n.X□□□		<b>Polarity Selection</b>								
		0	Set the signal to always enable forward drive.								
		1	Active when input signal is ON (closed).								
		2	Active when input signal is OFF (open).								
		3	Set the signal to always prohibit forward drive.								

Continued on next page.

Continued from previous page.

Parameter No.	Size	Name	Setting Range	Setting Unit	Default Setting	Applicable Motors	When Enabled	Classification	Reference		
Pn591	2	N-OT (Reverse Drive Prohibit) Signal Allocation	0000h to 3019h	–	Axis A: 1004h, Axis B: 1010h	All	After restart	Setup	page 5-29, page 6-4		
			<b>Allocated Pin Number</b>								
			n.□XXX	003	Allocate the signal to CN1-3.						
			n.□XXX	004	Allocate the signal to CN1-4.						
			n.□XXX	005	Allocate the signal to CN1-5.						
			n.□XXX	006	Allocate the signal to CN1-6.						
			n.□XXX	007	Allocate the signal to CN1-7.						
			n.□XXX	008	Allocate the signal to CN1-8.						
			n.□XXX	009	Allocate the signal to CN1-9.						
			n.□XXX	010	Allocate the signal to CN1-10.						
			n.□XXX	011	Allocate the signal to CN1-11.						
			n.□XXX	012	Allocate the signal to CN1-12.						
			n.□XXX	013	Allocate the signal to CN1-13.						
			n.□XXX	014	Allocate the signal to CN1-14.						
			<b>Polarity Selection</b>								
		n.X□□□	0	Set the signal to always enable reverse drive.							
		n.X□□□	1	Active when input signal is ON (closed).							
		n.X□□□	2	Active when input signal is OFF (open).							
		n.X□□□	3	Set the signal to always prohibit reverse drive.							
Pn592	2	/DEC (Origin Return Deceleration Switch Input) Signal Allocation	0000h to 3019h	–	Axis A: 1005h, Axis B: 1011h	All	After restart	Setup	–		
			<b>Allocated Pin Number</b>								
			n.□XXX	003	Allocate the signal to CN1-3.						
			n.□XXX	004	Allocate the signal to CN1-4.						
			n.□XXX	005	Allocate the signal to CN1-5.						
			n.□XXX	006	Allocate the signal to CN1-6.						
			n.□XXX	007	Allocate the signal to CN1-7.						
			n.□XXX	008	Allocate the signal to CN1-8.						
			n.□XXX	009	Allocate the signal to CN1-9.						
			n.□XXX	010	Allocate the signal to CN1-10.						
			n.□XXX	011	Allocate the signal to CN1-11.						
			n.□XXX	012	Allocate the signal to CN1-12.						
			n.□XXX	013	Allocate the signal to CN1-13.						
			n.□XXX	014	Allocate the signal to CN1-14.						
			<b>Polarity Selection</b>								
		n.X□□□	0	The signal is always inactive.							
		n.X□□□	1	Active when input signal is ON (closed).							
		n.X□□□	2	Active when input signal is OFF (open).							
		n.X□□□	3	The signal is always active.							

Continued on next page.

11.1 List of Servo Parameters

11.1.2 List of Servo Parameters

Continued from previous page.

Parameter No.	Size	Name	Setting Range	Setting Unit	Default Setting	Applicable Motors	When Enabled	Classification	Reference	
Pn593	2	/EXT1 (External Latch Input 1) Signal Allocation	0000h to 2019h	-	Axis A: 1006h, Axis B: 1012h	All	After restart	Setup	-	
			<b>Allocated Pin Number</b>							
			000 to 005	The signal is always inactive.						
			006	Allocate the signal to CN1-6.						
			007	Allocate the signal to CN1-7.						
			008	Allocate the signal to CN1-8.						
			009 to 011	The signal is always inactive.						
			012	Allocate the signal to CN1-12.						
			013	Allocate the signal to CN1-13.						
			014	Allocate the signal to CN1-14.						
			<b>Polarity Selection</b>							
			0	The signal is always inactive.						
			1	Active when input signal is ON (closed).						
			2	Active when input signal is OFF (open).						
	Pn594	2	/EXT2 (External Latch Input 2) Signal Allocation	0000h to 2019h	-	Axis A: 1007h, Axis B: 1013h	All	After restart	Setup	-
		<b>Allocated Pin Number</b>								
		000 to 005	The signal is always inactive.							
		006	Allocate the signal to CN1-6.							
		007	Allocate the signal to CN1-7.							
		008	Allocate the signal to CN1-8.							
		009 to 011	The signal is always inactive.							
		012	Allocate the signal to CN1-12.							
		013	Allocate the signal to CN1-13.							
		014	Allocate the signal to CN1-14.							
		<b>Polarity Selection</b>								
		0	The signal is always inactive.							
		1	Active when input signal is ON (closed).							
		2	Active when input signal is OFF (open).							

Continued on next page.

Continued from previous page.

Parameter No.	Size	Name	Setting Range	Setting Unit	Default Setting	Applicable Motors	When Enabled	Classification	Reference	
Pn595	2	/EXT3 (External Latch Input 3) Signal Allocation	0000h to 2019h	–	Axis A: 1008h, Axis B: 1014h	All	After restart	Setup	–	
			<b>Allocated Pin Number</b>							
			000 to 005	The signal is always inactive.						
			006	Allocate the signal to CN1-6.						
			007	Allocate the signal to CN1-7.						
			008	Allocate the signal to CN1-8.						
			009 to 011	The signal is always inactive.						
			012	Allocate the signal to CN1-12.						
			013	Allocate the signal to CN1-13.						
			014	Allocate the signal to CN1-14.						
			<b>Polarity Selection</b>							
			0	The signal is always inactive.						
			1	Active when input signal is ON (closed).						
			2	Active when input signal is OFF (open).						
	Pn597	2	FSTP (Forced Stop Input) Signal Allocation	0000h to 3019h	–	0000h	All	After restart	Setup	page 6-45
		<b>Allocated Pin Number</b>								
		003	Allocate the signal to CN1-3.							
		004	Allocate the signal to CN1-4.							
		005	Allocate the signal to CN1-5.							
		006	Allocate the signal to CN1-6.							
		007	Allocate the signal to CN1-7.							
		008	Allocate the signal to CN1-8.							
		009	Allocate the signal to CN1-9.							
		010	Allocate the signal to CN1-10.							
		011	Allocate the signal to CN1-11.							
		012	Allocate the signal to CN1-12.							
		013	Allocate the signal to CN1-13.							
		014	Allocate the signal to CN1-14.							
		<b>Polarity Selection</b>								
		0	Set the signal to always enable drive (always disable forcing the motor to stop).							
		1	Enable drive when the input signal is ON (closed).							
		2	Enable drive when the input signal is OFF (open).							
		3	Set the signal to always prohibit drive (always force the motor to stop).							

Continued on next page.

11.1 List of Servo Parameters

11.1.2 List of Servo Parameters

Continued from previous page.

Parameter No.	Size	Name	Setting Range	Setting Unit	Default Setting	Applicable Motors	When Enabled	Classification	Reference																			
Pn598	2	/P-CL (Forward External Torque Limit Input) Signal Allocation	0000h to 3019h	-	0000h	All	After restart	Setup	page 6-4, page 6-23																			
	<table border="1"> <thead> <tr> <th colspan="2">Allocated Pin Number</th> </tr> </thead> <tbody> <tr><td>003</td><td>Allocate the signal to CN1-3.</td></tr> <tr><td>004</td><td>Allocate the signal to CN1-4.</td></tr> <tr><td>005</td><td>Allocate the signal to CN1-5.</td></tr> <tr><td>006</td><td>Allocate the signal to CN1-6.</td></tr> <tr><td>007</td><td>Allocate the signal to CN1-7.</td></tr> <tr><td>008</td><td>Allocate the signal to CN1-8.</td></tr> <tr><td>009</td><td>Allocate the signal to CN1-9.</td></tr> <tr><td>010</td><td>Allocate the signal to CN1-10.</td></tr> <tr><td>011</td><td>Allocate the signal to CN1-11.</td></tr> <tr><td>012</td><td>Allocate the signal to CN1-12.</td></tr> <tr><td>013</td><td>Allocate the signal to CN1-13.</td></tr> <tr><td>014</td><td>Allocate the signal to CN1-14.</td></tr> </tbody> </table>		Allocated Pin Number		003	Allocate the signal to CN1-3.	004	Allocate the signal to CN1-4.	005	Allocate the signal to CN1-5.	006	Allocate the signal to CN1-6.	007	Allocate the signal to CN1-7.	008	Allocate the signal to CN1-8.	009	Allocate the signal to CN1-9.	010	Allocate the signal to CN1-10.	011	Allocate the signal to CN1-11.	012	Allocate the signal to CN1-12.	013	Allocate the signal to CN1-13.	014	Allocate the signal to CN1-14.
	Allocated Pin Number																											
	003	Allocate the signal to CN1-3.																										
	004	Allocate the signal to CN1-4.																										
	005	Allocate the signal to CN1-5.																										
	006	Allocate the signal to CN1-6.																										
	007	Allocate the signal to CN1-7.																										
	008	Allocate the signal to CN1-8.																										
	009	Allocate the signal to CN1-9.																										
	010	Allocate the signal to CN1-10.																										
	011	Allocate the signal to CN1-11.																										
	012	Allocate the signal to CN1-12.																										
	013	Allocate the signal to CN1-13.																										
	014	Allocate the signal to CN1-14.																										
	<table border="1"> <thead> <tr> <th colspan="2">Polarity Selection</th> </tr> </thead> <tbody> <tr><td>0</td><td>The signal is always inactive.</td></tr> <tr><td>1</td><td>Active when input signal is ON (closed).</td></tr> <tr><td>2</td><td>Active when input signal is OFF (open).</td></tr> <tr><td>3</td><td>The signal is always active.</td></tr> </tbody> </table>		Polarity Selection		0	The signal is always inactive.	1	Active when input signal is ON (closed).	2	Active when input signal is OFF (open).	3	The signal is always active.																
	Polarity Selection																											
	0	The signal is always inactive.																										
	1	Active when input signal is ON (closed).																										
	2	Active when input signal is OFF (open).																										
3	The signal is always active.																											
Pn599	2	/N-CL (Reverse External Torque Limit Input) Signal Allocation	0000h to 3019h	-	0000h	All	After restart	Setup	page 6-4, page 6-23																			
	<table border="1"> <thead> <tr> <th colspan="2">Allocated Pin Number</th> </tr> </thead> <tbody> <tr><td>003</td><td>Allocate the signal to CN1-3.</td></tr> <tr><td>004</td><td>Allocate the signal to CN1-4.</td></tr> <tr><td>005</td><td>Allocate the signal to CN1-5.</td></tr> <tr><td>006</td><td>Allocate the signal to CN1-6.</td></tr> <tr><td>007</td><td>Allocate the signal to CN1-7.</td></tr> <tr><td>008</td><td>Allocate the signal to CN1-8.</td></tr> <tr><td>009</td><td>Allocate the signal to CN1-9.</td></tr> <tr><td>010</td><td>Allocate the signal to CN1-10.</td></tr> <tr><td>011</td><td>Allocate the signal to CN1-11.</td></tr> <tr><td>012</td><td>Allocate the signal to CN1-12.</td></tr> <tr><td>013</td><td>Allocate the signal to CN1-13.</td></tr> <tr><td>014</td><td>Allocate the signal to CN1-14.</td></tr> </tbody> </table>		Allocated Pin Number		003	Allocate the signal to CN1-3.	004	Allocate the signal to CN1-4.	005	Allocate the signal to CN1-5.	006	Allocate the signal to CN1-6.	007	Allocate the signal to CN1-7.	008	Allocate the signal to CN1-8.	009	Allocate the signal to CN1-9.	010	Allocate the signal to CN1-10.	011	Allocate the signal to CN1-11.	012	Allocate the signal to CN1-12.	013	Allocate the signal to CN1-13.	014	Allocate the signal to CN1-14.
	Allocated Pin Number																											
	003	Allocate the signal to CN1-3.																										
	004	Allocate the signal to CN1-4.																										
	005	Allocate the signal to CN1-5.																										
	006	Allocate the signal to CN1-6.																										
	007	Allocate the signal to CN1-7.																										
	008	Allocate the signal to CN1-8.																										
	009	Allocate the signal to CN1-9.																										
	010	Allocate the signal to CN1-10.																										
	011	Allocate the signal to CN1-11.																										
	012	Allocate the signal to CN1-12.																										
	013	Allocate the signal to CN1-13.																										
	014	Allocate the signal to CN1-14.																										
	<table border="1"> <thead> <tr> <th colspan="2">Polarity Selection</th> </tr> </thead> <tbody> <tr><td>0</td><td>The signal is always inactive.</td></tr> <tr><td>1</td><td>Active when input signal is ON (closed).</td></tr> <tr><td>2</td><td>Active when input signal is OFF (open).</td></tr> <tr><td>3</td><td>The signal is always active.</td></tr> </tbody> </table>		Polarity Selection		0	The signal is always inactive.	1	Active when input signal is ON (closed).	2	Active when input signal is OFF (open).	3	The signal is always active.																
	Polarity Selection																											
	0	The signal is always inactive.																										
	1	Active when input signal is ON (closed).																										
	2	Active when input signal is OFF (open).																										
3	The signal is always active.																											

Continued on next page.

Continued from previous page.

Parameter No.	Size	Name	Setting Range	Setting Unit	Default Setting	Applicable Motors	When Enabled	Classification	Reference	
Pn5B0	2	/COIN (Positioning Completion Output) Signal Allocation	0000h to 2039h	–	0000h	All	After restart	Setup	page 6-8, page 6-13	
			<b>Allocated Pin Number</b>							
			023	Allocate the signal to CN1-23.						
			025	Allocate the signal to CN1-25.						
			027	Allocate the signal to CN1-27.						
			029	Allocate the signal to CN1-29.						
			031	Allocate the signal to CN1-31.						
			<b>Polarity Selection</b>							
			0	Disabled (the above signal output is not used).						
			1	Output the above signal.						
			2	Invert the above signal and output it.						
Pn5B1	2	/V-CMP (Speed Coincidence Detection Output) Signal Allocation	0000h to 2039h	–	0000h	All	After restart	Setup	page 6-8, page 6-12	
			<b>Allocated Pin Number</b>							
			023	Allocate the signal to CN1-23.						
			025	Allocate the signal to CN1-25.						
			027	Allocate the signal to CN1-27.						
			029	Allocate the signal to CN1-29.						
			031	Allocate the signal to CN1-31.						
			<b>Polarity Selection</b>							
			0	Disabled (the above signal output is not used).						
			1	Output the above signal.						
			2	Invert the above signal and output it.						
Pn5B2	2	/TGON (Rotation Detection Output) Signal Allocation	0000h to 2039h	–	0000h	All	After restart	Setup	page 6-8, page 6-11	
			<b>Allocated Pin Number</b>							
			023	Allocate the signal to CN1-23.						
			025	Allocate the signal to CN1-25.						
			027	Allocate the signal to CN1-27.						
			029	Allocate the signal to CN1-29.						
			031	Allocate the signal to CN1-31.						
			<b>Polarity Selection</b>							
			0	Disabled (the above signal output is not used).						
			1	Output the above signal.						
			2	Invert the above signal and output it.						

Continued on next page.

11.1 List of Servo Parameters

11.1.2 List of Servo Parameters

Continued from previous page.

Parameter No.	Size	Name	Setting Range	Setting Unit	Default Setting	Applicable Motors	When Enabled	Classification	Reference			
Pn5B3	2	/S-RDY (Servo Ready) Signal Allocation	0000h to 2039h	-	0000h	All	After restart	Setup	page 6-8, page 6-12			
										n.□XXX	Allocated Pin Number	
											023	Allocate the signal to CN1-23.
											025	Allocate the signal to CN1-25.
											027	Allocate the signal to CN1-27.
											029	Allocate the signal to CN1-29.
										031	Allocate the signal to CN1-31.	
										n.X□□□	Polarity Selection	
											0	Disabled (the above signal output is not used).
											1	Output the above signal.
										2	Invert the above signal and output it.	
Pn5B4	2	/CLT (Torque Limit Detection Output) Signal Allocation	0000h to 2039h	-	0000h	All	After restart	Setup	page 6-8, page 6-26			
										n.□XXX	Allocated Pin Number	
											023	Allocate the signal to CN1-23.
											025	Allocate the signal to CN1-25.
											027	Allocate the signal to CN1-27.
											029	Allocate the signal to CN1-29.
										031	Allocate the signal to CN1-31.	
										n.X□□□	Polarity Selection	
											0	Disabled (the above signal output is not used).
											1	Output the above signal.
										2	Invert the above signal and output it.	
Pn5B5	2	/VLT (Speed Limit Detection) Signal Allocation	0000h to 2039h	-	0000h	All	After restart	Setup	page 6-8, page 6-15			
										n.□XXX	Allocated Pin Number	
											023	Allocate the signal to CN1-23.
											025	Allocate the signal to CN1-25.
											027	Allocate the signal to CN1-27.
											029	Allocate the signal to CN1-29.
										031	Allocate the signal to CN1-31.	
										n.X□□□	Polarity Selection	
											0	Disabled (the above signal output is not used).
											1	Output the above signal.
										2	Invert the above signal and output it.	

Continued on next page.

Continued from previous page.

Parameter No.	Size	Name	Setting Range	Setting Unit	Default Setting	Applicable Motors	When Enabled	Classification	Reference		
Pn5B6	2	/BK (Brake Output) Signal Allocation	0000h to 2039h	-	Axis A: 1023h, Axis B: 1025h	All	After restart	Setup	page 6-8		
			<b>Allocated Pin Number</b>								
			n.□XXX	023	Allocate the signal to CN1-23.						
			n.□XXX	025	Allocate the signal to CN1-25.						
			n.□XXX	027	Allocate the signal to CN1-27.						
			n.□XXX	029	Allocate the signal to CN1-29.						
			n.□XXX	031	Allocate the signal to CN1-31.						
			<b>Polarity Selection</b>								
			n.X□□□	0	Disabled (the above signal output is not used).						
			n.X□□□	1	Output the above signal.						
			n.X□□□	2	Invert the above signal and output it.						
Pn5B7	2	/WARN (Warning Output) Signal Allocation	0000h to 2039h	-	0000h	All	After restart	Setup	page 6-8, page 6-10		
			<b>Allocated Pin Number</b>								
			n.□XXX	023	Allocate the signal to CN1-23.						
			n.□XXX	025	Allocate the signal to CN1-25.						
			n.□XXX	027	Allocate the signal to CN1-27.						
			n.□XXX	029	Allocate the signal to CN1-29.						
			n.□XXX	031	Allocate the signal to CN1-31.						
			<b>Polarity Selection</b>								
			n.X□□□	0	Disabled (the above signal output is not used).						
			n.X□□□	1	Output the above signal.						
			n.X□□□	2	Invert the above signal and output it.						
Pn5B8	2	/NEAR (Near Output) Signal Allocation	0000h to 2039h	-	0000h	All	After restart	Setup	page 6-8, page 6-14		
			<b>Allocated Pin Number</b>								
			n.□XXX	023	Allocate the signal to CN1-23.						
			n.□XXX	025	Allocate the signal to CN1-25.						
			n.□XXX	027	Allocate the signal to CN1-27.						
			n.□XXX	029	Allocate the signal to CN1-29.						
			n.□XXX	031	Allocate the signal to CN1-31.						
			<b>Polarity Selection</b>								
			n.X□□□	0	Disabled (the above signal output is not used).						
			n.X□□□	1	Output the above signal.						
			n.X□□□	2	Invert the above signal and output it.						

Continued on next page.



11.1 List of Servo Parameters

11.1.2 List of Servo Parameters

Continued from previous page.

Parameter No.	Size	Name	Setting Range	Setting Unit	Default Setting	Applicable Motors	When Enabled	Classification	Reference													
Pn5BC	2	/PM (Preventative Maintenance Output) Signal Allocation	0000h to 2039h	-	0000h	All	After restart	Setup	page 9-16													
			<table border="1"> <thead> <tr> <th colspan="2">Allocated Pin Number</th> </tr> </thead> <tbody> <tr> <td>023</td> <td>Allocate the signal to CN1-23.</td> </tr> <tr> <td>025</td> <td>Allocate the signal to CN1-25.</td> </tr> <tr> <td>027</td> <td>Allocate the signal to CN1-27.</td> </tr> <tr> <td>029</td> <td>Allocate the signal to CN1-29.</td> </tr> <tr> <td>031</td> <td>Allocate the signal to CN1-31.</td> </tr> </tbody> </table>								Allocated Pin Number		023	Allocate the signal to CN1-23.	025	Allocate the signal to CN1-25.	027	Allocate the signal to CN1-27.	029	Allocate the signal to CN1-29.	031	Allocate the signal to CN1-31.
	Allocated Pin Number																					
	023	Allocate the signal to CN1-23.																				
	025	Allocate the signal to CN1-25.																				
	027	Allocate the signal to CN1-27.																				
	029	Allocate the signal to CN1-29.																				
	031	Allocate the signal to CN1-31.																				
			<table border="1"> <thead> <tr> <th colspan="2">Polarity Selection</th> </tr> </thead> <tbody> <tr> <td>0</td> <td>Disabled (the above signal output is not used).</td> </tr> <tr> <td>1</td> <td>Output the above signal.</td> </tr> <tr> <td>2</td> <td>Invert the above signal and output it.</td> </tr> </tbody> </table>								Polarity Selection		0	Disabled (the above signal output is not used).	1	Output the above signal.	2	Invert the above signal and output it.				
	Polarity Selection																					
0	Disabled (the above signal output is not used).																					
1	Output the above signal.																					
2	Invert the above signal and output it.																					
Pn600 All Axes	2	Regenerative Resistor Capacity*3	Depends on model.*4	10 W	0	All	Immediately	Setup	page 5-54													
Pn601	2	Dynamic Brake Resistor Allowable Energy Consumption	0 to 65,535	10 J	0	All	After restart	Setup	*5													
Pn603 All Axes	2	Regenerative Resistance	0 to 65,535	10 mΩ	0	All	Immediately	Setup	page 5-54													
Pn604	2	Dynamic Brake Resistance	0 to 65,535	10 mΩ	0	All	After restart	Setup	*5													
Pn61A	2	Overheat Protection Selections	0000h to 0003h	-	0000h	All	After restart	Setup	page 6-48													
			<table border="1"> <thead> <tr> <th colspan="2">Overheat Protection Selection</th> </tr> </thead> <tbody> <tr> <td>0</td> <td>Disable overheat protection.</td> </tr> <tr> <td>1</td> <td>Use overheat protection in the Yaskawa Linear Servomotor.*6</td> </tr> <tr> <td>2</td> <td>Monitor a negative voltage input from a sensor attached to the machine and use overheat protection.</td> </tr> <tr> <td>3</td> <td>Monitor a positive voltage input from a sensor attached to the machine and use overheat protection.</td> </tr> </tbody> </table>								Overheat Protection Selection		0	Disable overheat protection.	1	Use overheat protection in the Yaskawa Linear Servomotor.*6	2	Monitor a negative voltage input from a sensor attached to the machine and use overheat protection.	3	Monitor a positive voltage input from a sensor attached to the machine and use overheat protection.		
	Overheat Protection Selection																					
	0	Disable overheat protection.																				
	1	Use overheat protection in the Yaskawa Linear Servomotor.*6																				
	2	Monitor a negative voltage input from a sensor attached to the machine and use overheat protection.																				
	3	Monitor a positive voltage input from a sensor attached to the machine and use overheat protection.																				
		n.□□□□ Reserved parameter (Do not change.)																				
		n.□X□□ Reserved parameter (Do not change.)																				
		n.X□□□ Reserved parameter (Do not change.)																				
Pn61B *7 All Axes	2	Overheat Alarm Level	0 to 500	0.01 V	250	All	Immediately	Setup	page 6-49													
Pn61C *7 All Axes	2	Overheat Warning Level	0 to 100	1%	100	All	Immediately	Setup	page 6-49													
Pn61D *7 All Axes	2	Overheat Alarm Filter Time	0 to 65,535	1 s	0	All	Immediately	Setup	page 6-49													

Continued on next page.

Continued from previous page.

Parameter No.	Size	Name	Setting Range	Setting Unit	Default Setting	Applicable Motors	When Enabled	Classification	Reference	
Pn800	2	Communications Controls	0000h to 1FF3h	-	1040h	All	Immediately	Setup	-	
	n.□□□X		<b>MECHATROLINK Communications Check Mask for Debugging</b>							
			0	Do not mask.						
			1	Ignore MECHATROLINK communications errors (A.E60).						
			2	Ignore WDT errors (A.E50).						
			3	Ignore both MECHATROLINK communications errors (A.E60) and WDT errors (A.E50).						
	n.□□X□		<b>Warning Check Masks</b>							
			0	Do not mask.						
			1	Ignore data setting warnings (A.94□).						
			2	Ignore command warnings (A.95□).						
			3	Ignore both A.94□ and A.95□ warnings.						
			4	Ignore communications warnings (A.96□).						
			5	Ignore both A.94□ and A.96□ warnings.						
			6	Ignore both A.95□ and A.96□ warnings.						
			7	Ignore A.94□, A.95□, and A.96□ warnings.						
			8	Ignore data setting warnings (A.97A and A.97b).						
			9	Ignore A.94□, A.97A, and A.97b warnings.						
			A	Ignore A.95□, A.97A, and A.97b warnings.						
			B	Ignore A.94□, A.95□, A.97A, and A.97b warnings.						
			C	Ignore A.96□, A.97A, and A.97b warnings.						
			D	Ignore A.94□, A.96□, A.97A, and A.97b warnings.						
			E	Ignore A.95□, A.96□, A.97A, and A.97b warnings.						
			F	Ignore A.94□, A.95□, A.96□, A.97A, and A.97b warnings.						
	n.□X□□		Reserved parameter (Do not change.)							
	n.X□□□		<b>Automatic Warning Clear Selection for Debugging<sup>*8</sup></b>							
	M3 <sup>*8</sup>		0	Retain warnings for debugging.						
		1	Automatically clear warnings (MECHATROLINK-III specification).							
Pn801	2	Application Function Selections 6 (Software Limits)	0000h to 0103h	-	0003h	All	Immediately	Setup	page 6-21	
	n.□□□X		<b>Software Limit Selection</b>							
			0	Enable both forward and reverse software limits.						
			1	Disable forward software limit.						
			2	Disable reverse software limit.						
			3	Disable both forward and reverse software limits.						
	n.□□X□		Reserved parameter (Do not change.)							
	n.□X□□		<b>Software Limit Check for References</b>							
			0	Do not perform software limit checks for references.						
			1	Perform software limit checks for references.						
n.X□□□		Reserved parameter (Do not change.)								
Pn803	2	Origin Range	0 to 250	1 reference unit	10	All	Immediately	Setup	*1	

Continued on next page.

11.1 List of Servo Parameters

11.1.2 List of Servo Parameters

Continued from previous page.

Parameter No.	Size	Name	Setting Range	Setting Unit	Default Setting	Applicable Motors	When Enabled	Classification	Reference							
Pn804	4	Forward Software Limit	-1,073,741,823 to 1,073,741,823	1 reference unit	1073741823	All	Immediately	Setup	page 6-21							
Pn806	4	Reverse Software Limit	-1,073,741,823 to 1,073,741,823	1 reference unit	-1073741823	All	Immediately	Setup	page 6-21							
Pn808	4	Absolute Encoder Origin Offset	-1,073,741,823 to 1,073,741,823	1 reference unit	0	All	Immediately <sup>*9</sup>	Setup	page 5-51							
Pn80A	2	First Stage Linear Acceleration Constant	1 to 65,535	10,000 reference units/s <sup>2</sup>	100	All	Immediately <sup>*10</sup>	Setup	*1							
Pn80B	2	Second Stage Linear Acceleration Constant	1 to 65,535	10,000 reference units/s <sup>2</sup>	100	All	Immediately <sup>*10</sup>	Setup	*1							
Pn80C	2	Acceleration Constant Switching Speed	0 to 65,535	100 reference units/s	0	All	Immediately <sup>*10</sup>	Setup	*1							
Pn80D	2	First Stage Linear Deceleration Constant	1 to 65,535	10,000 reference units/s <sup>2</sup>	100	All	Immediately <sup>*10</sup>	Setup	*1							
Pn80E	2	Second Stage Linear Deceleration Constant	1 to 65,535	10,000 reference units/s <sup>2</sup>	100	All	Immediately <sup>*10</sup>	Setup	*1							
Pn80F	2	Deceleration Constant Switching Speed	0 to 65,535	100 reference units/s	0	All	Immediately <sup>*10</sup>	Setup	*1							
Pn810	2	Exponential Acceleration/Deceleration Bias	0 to 65,535	100 reference units/s	0	All	Immediately <sup>*11</sup>	Setup	*1							
Pn811	2	Exponential Acceleration/Deceleration Time Constant	0 to 5,100	0.1 ms	0	All	Immediately <sup>*11</sup>	Setup	*1							
Pn812	2	Movement Average Time	0 to 5,100	0.1 ms	0	All	Immediately <sup>*11</sup>	Setup	*1							
Pn814	4	External Positioning Final Travel Distance	-1,073,741,823 to 1,073,741,823	1 reference unit	100	All	Immediately	Setup	*1							
Pn816 <sup>*13</sup> <b>M2</b>	2	Origin Return Mode Settings	0000h to 0001h	-	0000h	All	Immediately	Setup	*11							
			<table border="1"> <thead> <tr> <th colspan="2">Origin Return Direction</th> </tr> </thead> <tbody> <tr> <td>0</td> <td>Return in forward direction.</td> </tr> <tr> <td>1</td> <td>Return in reverse direction.</td> </tr> </tbody> </table>								Origin Return Direction		0	Return in forward direction.	1	Return in reverse direction.
	Origin Return Direction															
	0	Return in forward direction.														
	1	Return in reverse direction.														
			n.□□□□ Reserved parameter (Do not change.)													
		n.□X□□ Reserved parameter (Do not change.)														
		n.X□□□ Reserved parameter (Do not change.)														
Pn817 <sup>*14</sup>	2	Origin Approach Speed 1	0 to 65,535	100 reference units/s	50	All	Immediately <sup>*10</sup>	Setup	*1							
Pn818 <sup>*15</sup>	2	Origin Approach Speed 2	0 to 65,535	100 reference units/s	5	All	Immediately <sup>*10</sup>	Setup	*1							
Pn819	4	Final Travel Distance for Origin Return	-1,073,741,823 to 1,073,741,823	1 reference unit	100	All	Immediately	Setup	*1							

Continued on next page.

Continued from previous page.

Parameter No.	Size	Name	Setting Range	Setting Unit	Default Setting	Applicable Motors	When Enabled	Classification	Reference	
Pn81E M2 <sup>*13</sup>	2	Input Signal Monitor Selections	0000h to CCCCh	-	0000h	All	Immediately	Setup	*12	
			<b>IO12 Signal Mapping</b>							
			0	Do not map.						
			1	Monitor CN1-1 input terminal.						
			2	Monitor CN1-2 input terminal.						
			3	Monitor CN1-3 input terminal.						
			4	Monitor CN1-4 input terminal.						
			5	Monitor CN1-5 input terminal.						
			6	Monitor CN1-6 input terminal.						
			7	Monitor CN1-11 input terminal.						
			8	Monitor CN1-12 input terminal.						
			9	Monitor CN1-13 input terminal.						
			A	Monitor CN1-14 input terminal.						
			B	Monitor CN1-15 input terminal.						
			C	Monitor CN1-16 input terminal.						
		<b>IO13 Signal Mapping</b>								
		0 to C	The mappings are the same as the IO12 signal mappings.							
		<b>IO14 Signal Mapping</b>								
		0 to C	The mappings are the same as the IO12 signal mappings.							
		<b>IO15 Signal Mapping</b>								
		0 to C	The mappings are the same as the IO12 signal mappings.							
Pn81F M2 <sup>*13</sup>	2	Command Data Allocations	0000h to 1111h	-	0010h	All	After restart	Setup	*12	
			<b>Option Field Allocation</b>							
			0	Disable option field allocation.						
			1	Enable option field allocation.						
			<b>Position Control Command TFF/TLIM Allocation</b>							
			0	Disable allocation.						
		1	Enable allocation.							
		n.XXXX Reserved parameter (Do not change.)								
		n.XXXX Reserved parameter (Do not change.)								
Pn820	4	Forward Latching Area	-2,147,483,648 to 2,147,483,647	1 reference unit	0	All	Immediately	Setup	*1	
Pn822	4	Reverse Latching Area	-2,147,483,648 to 2,147,483,647	1 reference unit	0	All	Immediately	Setup	*1	

Continued on next page.

11.1 List of Servo Parameters

11.1.2 List of Servo Parameters

Continued from previous page.

Parameter No.	Size	Name	Setting Range	Setting Unit	Default Setting	Applicable Motors	When Enabled	Classification	Reference	
Pn824 M3**8	2	Option Monitor 1 Selection	0000h to FFFFh	-	0000h	-	Immediately	Setup	*1	
			<b>Setting</b>	<b>Monitor</b>			<b>Applicable Motors</b>			
	<b>High-Speed Monitor Region</b>									
			0000h	Motor speed [1000000h/overspeed detection speed]				All		
			0001h	Speed reference [1000000h/overspeed detection speed]				All		
			0002h	Torque [1000000h/maximum torque]				All		
			0003h	Position deviation (lower 32 bits) [reference units]				All		
			0004h	Position deviation (upper 32 bits) [reference units]				All		
			000Ah	Encoder count (lower 32 bits) [reference units]				All		
			000Bh	Encoder count (upper 32 bits) [reference units]				All		
	<b>Low-Speed Monitor Region</b>									
			0010h	Un000: Motor speed [min <sup>-1</sup> ]				All		
			0011h	Un001: Speed Reference [min <sup>-1</sup> ]				All		
			0012h	Un002: Torque Reference [%]				All		
			0013h	Un003: Rotational Angle 1 [encoder pulses] Number of encoder pulses from origin within one encoder rotation displayed in decimal				All		
				Un003: Electrical Angle 1 [linear encoder pulses] Linear encoder pulses from the polarity origin displayed in decimal						
			0014h	Un004: Rotational Angle 2 [deg] Electrical angle from polarity origin				All		
				Un004: Electrical Angle 2 [deg] Electrical angle from polarity origin						
			0015h	Un005: Input Signal Monitor				All		
			0016h	Un006: Output Signal Monitor				All		
			0017h	Un007: Input Reference Speed [min <sup>-1</sup> ]				All		
			0018h	Un008: Position Deviation [reference units]				All		
			0019h	Un009: Accumulated Load Ratio [%]				All		
			001Ah	Un00A: Regenerative Load Ratio [%]				All		
			001Bh	Un00B: Dynamic Brake Resistor Power Consumption [%]				All		
			001Ch	Un00C: Input Reference Pulse Counter [reference units]				All		
			001Dh	Un00D: Feedback Pulse Counter [encoder pulses]				All		
			0023h	Initial multiturn data [Rev]				Rotary		
			0024h	Initial incremental data [pulses]				Rotary		
			0025h	Initial absolute position data (lower 32 bits) [pulses]				Linear		
			0026h	Initial absolute position data (upper 32 bits) [pulses]				Linear		
			0040h	Un025: SERVOPACK Installation Environment Monitor				All		
			0041h	Un026: Servomotor Installation Environment Monitor				All		
			0042h	Un027: Built-in Fan Remaining Life Ratio				All		
		0043h	Un028: Capacitor Remaining Life Ratio				All			
		0044h	Un029: Surge Prevention Circuit Remaining Life Ratio				All			
		0045h	Un02A: Dynamic Brake Circuit Remaining Life Ratio				All			
		0046h	Un032: Instantaneous Power				All			
		0047h	Un033: Power Consumption				All			
		0048h	Un034: Cumulative Power Consumption				All			

Continued on next page.

Continued from previous page.

Parameter No.	Size	Name	Setting Range	Setting Unit	Default Setting	Applicable Motors	When Enabled	Classification	Reference	
Pn824 M3 <sup>*8</sup>	Setting		Monitor				Applicable Motors			
	Communications Module Only									
	0080h	Previous value of latched feedback position (LPOS1) [reference units]					All			
	0081h	Previous value of latched feedback position (LPOS2) [reference units]					All			
	0084h	Continuous Latch Status (EX STATUS)					All			
	All Areas									
	Other values	Reserved settings (Do not use.)					All			
Pn825	2	Option Monitor 2 Selection	0000h to FFFFh	–	0000h	All	Immediately	Setup	*1	
		0000h to 0084h	The settings are the same as those for the Option Monitor 1 Selection.							
Pn827	2	Linear Deceleration Constant 1 for Stopping	1 to 65,535	10,000 reference units/s <sup>2</sup>	100	All	Immediately <sup>*10</sup>	Setup	*1	
Pn829	2	SVOFF Waiting Time (for SVOFF at Deceleration to Stop)	0 to 65,535	10 ms	0	All	Immediately <sup>*10</sup>	Setup	*1	
Pn82A M2 <sup>*13</sup>	2	Option Field Allocations 1	0000h to 1E1Eh	–	1813h	All	After restart	Setup	*12	
	n.□□□X	ACCFIL Allocation (Option)								
		0	Allocate bits 0 and 1 to ACCFIL.							
		1	Allocate bits 1 and 2 to ACCFIL.							
		2	Allocate bits 2 and 3 to ACCFIL.							
		3	Allocate bits 3 and 4 to ACCFIL.							
		4	Allocate bits 4 and 5 to ACCFIL.							
		5	Allocate bits 5 and 6 to ACCFIL.							
		6	Allocate bits 6 and 7 to ACCFIL.							
		7	Allocate bits 7 and 8 to ACCFIL.							
		8	Allocate bits 8 and 9 to ACCFIL.							
		9	Allocate bits 9 and 10 to ACCFIL.							
		A	Allocate bits 10 and 11 to ACCFIL.							
		B	Allocate bits 11 and 12 to ACCFIL.							
		C	Allocate bits 12 and 13 to ACCFIL.							
D	Allocate bits 13 and 14 to ACCFIL.									
E	Allocate bits 14 and 15 to ACCFIL.									
n.□□X□	ACCFIL Allocation Enable/Disable Selection									
	0	Disable ACCFIL allocation.								
1	Enable ACCFIL allocation.									
n.□X□□	G_SEL Allocation (Option)									
	0 to E	The settings are the same as for the ACCFIL allocations.								
n.X□□□	G_SEL Allocation Enable/Disable Selection									
	0	Disable G_SEL allocation.								
1	Enable G_SEL allocation.									

Continued on next page.

11.1 List of Servo Parameters

11.1.2 List of Servo Parameters

Continued from previous page.

Parameter No.	Size	Name	Setting Range	Setting Unit	Default Setting	Applicable Motors	When Enabled	Classification	Reference																											
Pn82B M2*13	2	Option Field Allocations 2	0000h to 1F1Fh	-	1D1Ch	All	After restart	Setup	*12																											
	<table border="1"> <thead> <tr> <th colspan="2">V_PPI Allocation (Option)</th> </tr> </thead> <tbody> <tr><td>0</td><td>Allocate bit 0 to V_PPI.</td></tr> <tr><td>1</td><td>Allocate bit 1 to V_PPI.</td></tr> <tr><td>2</td><td>Allocate bit 2 to V_PPI.</td></tr> <tr><td>3</td><td>Allocate bit 3 to V_PPI.</td></tr> <tr><td>4</td><td>Allocate bit 4 to V_PPI.</td></tr> <tr><td>5</td><td>Allocate bit 5 to V_PPI.</td></tr> <tr><td>6</td><td>Allocate bit 6 to V_PPI.</td></tr> <tr><td>7</td><td>Allocate bit 7 to V_PPI.</td></tr> <tr><td>8</td><td>Allocate bit 8 to V_PPI.</td></tr> <tr><td>9</td><td>Allocate bit 9 to V_PPI.</td></tr> <tr><td>A</td><td>Allocate bit 10 to V_PPI.</td></tr> <tr><td>B</td><td>Allocate bit 11 to V_PPI.</td></tr> <tr><td>C</td><td>Allocate bit 12 to V_PPI.</td></tr> <tr><td>D</td><td>Allocate bit 13 to V_PPI.</td></tr> <tr><td>E</td><td>Allocate bit 14 to V_PPI.</td></tr> <tr><td>F</td><td>Allocate bit 15 to V_PPI.</td></tr> </tbody> </table>		V_PPI Allocation (Option)		0	Allocate bit 0 to V_PPI.	1	Allocate bit 1 to V_PPI.	2	Allocate bit 2 to V_PPI.	3	Allocate bit 3 to V_PPI.	4	Allocate bit 4 to V_PPI.	5	Allocate bit 5 to V_PPI.	6	Allocate bit 6 to V_PPI.	7	Allocate bit 7 to V_PPI.	8	Allocate bit 8 to V_PPI.	9	Allocate bit 9 to V_PPI.	A	Allocate bit 10 to V_PPI.	B	Allocate bit 11 to V_PPI.	C	Allocate bit 12 to V_PPI.	D	Allocate bit 13 to V_PPI.	E	Allocate bit 14 to V_PPI.	F	Allocate bit 15 to V_PPI.
	V_PPI Allocation (Option)																																			
	0	Allocate bit 0 to V_PPI.																																		
	1	Allocate bit 1 to V_PPI.																																		
	2	Allocate bit 2 to V_PPI.																																		
	3	Allocate bit 3 to V_PPI.																																		
	4	Allocate bit 4 to V_PPI.																																		
	5	Allocate bit 5 to V_PPI.																																		
	6	Allocate bit 6 to V_PPI.																																		
	7	Allocate bit 7 to V_PPI.																																		
	8	Allocate bit 8 to V_PPI.																																		
	9	Allocate bit 9 to V_PPI.																																		
	A	Allocate bit 10 to V_PPI.																																		
	B	Allocate bit 11 to V_PPI.																																		
	C	Allocate bit 12 to V_PPI.																																		
	D	Allocate bit 13 to V_PPI.																																		
	E	Allocate bit 14 to V_PPI.																																		
	F	Allocate bit 15 to V_PPI.																																		
	<table border="1"> <thead> <tr> <th colspan="2">V_PPI Allocation Enable/Disable Selection</th> </tr> </thead> <tbody> <tr><td>0</td><td>Disable V_PPI allocation.</td></tr> <tr><td>1</td><td>Enable V_PPI allocation.</td></tr> </tbody> </table>		V_PPI Allocation Enable/Disable Selection		0	Disable V_PPI allocation.	1	Enable V_PPI allocation.																												
	V_PPI Allocation Enable/Disable Selection																																			
	0	Disable V_PPI allocation.																																		
	1	Enable V_PPI allocation.																																		
	<table border="1"> <thead> <tr> <th colspan="2">P_PI_CLR Allocation (Option)</th> </tr> </thead> <tbody> <tr><td>0 to F</td><td>The settings are the same as for the V_PPI allocations.</td></tr> </tbody> </table>		P_PI_CLR Allocation (Option)		0 to F	The settings are the same as for the V_PPI allocations.																														
P_PI_CLR Allocation (Option)																																				
0 to F	The settings are the same as for the V_PPI allocations.																																			
<table border="1"> <thead> <tr> <th colspan="2">P_PI_CLR Allocation Enable/Disable Selection</th> </tr> </thead> <tbody> <tr><td>0</td><td>Disable P_PI_CLR allocation.</td></tr> <tr><td>1</td><td>Enable P_PI_CLR allocation.</td></tr> </tbody> </table>		P_PI_CLR Allocation Enable/Disable Selection		0	Disable P_PI_CLR allocation.	1	Enable P_PI_CLR allocation.																													
P_PI_CLR Allocation Enable/Disable Selection																																				
0	Disable P_PI_CLR allocation.																																			
1	Enable P_PI_CLR allocation.																																			
Pn82C M2*13	2	Option Field Allocations 3	0000h to 1F1Fh	-	1F1Eh	All	After restart	Setup	*12																											
	<table border="1"> <thead> <tr> <th colspan="2">P_CL Allocation (Option)</th> </tr> </thead> <tbody> <tr><td>0 to F</td><td>The settings are the same as for the V_PPI allocations.</td></tr> </tbody> </table>		P_CL Allocation (Option)		0 to F	The settings are the same as for the V_PPI allocations.																														
	P_CL Allocation (Option)																																			
	0 to F	The settings are the same as for the V_PPI allocations.																																		
	<table border="1"> <thead> <tr> <th colspan="2">P_CL Allocation Enable/Disable Selection</th> </tr> </thead> <tbody> <tr><td>0</td><td>Disable P_CL allocation.</td></tr> <tr><td>1</td><td>Enable P_CL allocation.</td></tr> </tbody> </table>		P_CL Allocation Enable/Disable Selection		0	Disable P_CL allocation.	1	Enable P_CL allocation.																												
	P_CL Allocation Enable/Disable Selection																																			
	0	Disable P_CL allocation.																																		
	1	Enable P_CL allocation.																																		
	<table border="1"> <thead> <tr> <th colspan="2">N_CL Allocation (Option)</th> </tr> </thead> <tbody> <tr><td>0 to F</td><td>The settings are the same as for the V_PPI allocations.</td></tr> </tbody> </table>		N_CL Allocation (Option)		0 to F	The settings are the same as for the V_PPI allocations.																														
	N_CL Allocation (Option)																																			
	0 to F	The settings are the same as for the V_PPI allocations.																																		
	<table border="1"> <thead> <tr> <th colspan="2">N_CL Allocation Enable/Disable Selection</th> </tr> </thead> <tbody> <tr><td>0</td><td>Disable N_CL allocation.</td></tr> <tr><td>1</td><td>Enable N_CL allocation.</td></tr> </tbody> </table>		N_CL Allocation Enable/Disable Selection		0	Disable N_CL allocation.	1	Enable N_CL allocation.																												
N_CL Allocation Enable/Disable Selection																																				
0	Disable N_CL allocation.																																			
1	Enable N_CL allocation.																																			

Continued on next page.

Continued from previous page.

Parameter No.	Size	Name	Setting Range	Setting Unit	Default Setting	Applicable Motors	When Enabled	Classification	Reference																												
Pn82D M2 <sup>*13</sup>	2	Option Field Allocations	0000h to 1F1Ch	–	0000h	All	After restart	Setup	*12																												
		n.□□□X	<table border="1"> <thead> <tr> <th colspan="2">BANK_SEL1 Allocation (Option)</th> </tr> </thead> <tbody> <tr><td>0</td><td>Allocate bits 0 to 3 to BANK_SEL1.</td></tr> <tr><td>1</td><td>Allocate bits 1 to 4 to BANK_SEL1.</td></tr> <tr><td>2</td><td>Allocate bits 2 to 5 to BANK_SEL1.</td></tr> <tr><td>3</td><td>Allocate bits 3 to 6 to BANK_SEL1.</td></tr> <tr><td>4</td><td>Allocate bits 4 to 7 to BANK_SEL1.</td></tr> <tr><td>5</td><td>Allocate bits 5 to 8 to BANK_SEL1.</td></tr> <tr><td>6</td><td>Allocate bits 6 to 9 to BANK_SEL1.</td></tr> <tr><td>7</td><td>Allocate bits 7 to 10 to BANK_SEL1.</td></tr> <tr><td>8</td><td>Allocate bits 8 to 11 to BANK_SEL1.</td></tr> <tr><td>9</td><td>Allocate bits 9 to 12 to BANK_SEL1.</td></tr> <tr><td>A</td><td>Allocate bits 10 to 13 to BANK_SEL1.</td></tr> <tr><td>B</td><td>Allocate bits 11 to 14 to BANK_SEL1.</td></tr> <tr><td>C</td><td>Allocate bits 12 to 15 to BANK_SEL1.</td></tr> </tbody> </table>							BANK_SEL1 Allocation (Option)		0	Allocate bits 0 to 3 to BANK_SEL1.	1	Allocate bits 1 to 4 to BANK_SEL1.	2	Allocate bits 2 to 5 to BANK_SEL1.	3	Allocate bits 3 to 6 to BANK_SEL1.	4	Allocate bits 4 to 7 to BANK_SEL1.	5	Allocate bits 5 to 8 to BANK_SEL1.	6	Allocate bits 6 to 9 to BANK_SEL1.	7	Allocate bits 7 to 10 to BANK_SEL1.	8	Allocate bits 8 to 11 to BANK_SEL1.	9	Allocate bits 9 to 12 to BANK_SEL1.	A	Allocate bits 10 to 13 to BANK_SEL1.	B	Allocate bits 11 to 14 to BANK_SEL1.	C	Allocate bits 12 to 15 to BANK_SEL1.
	BANK_SEL1 Allocation (Option)																																				
	0	Allocate bits 0 to 3 to BANK_SEL1.																																			
	1	Allocate bits 1 to 4 to BANK_SEL1.																																			
	2	Allocate bits 2 to 5 to BANK_SEL1.																																			
	3	Allocate bits 3 to 6 to BANK_SEL1.																																			
	4	Allocate bits 4 to 7 to BANK_SEL1.																																			
	5	Allocate bits 5 to 8 to BANK_SEL1.																																			
	6	Allocate bits 6 to 9 to BANK_SEL1.																																			
	7	Allocate bits 7 to 10 to BANK_SEL1.																																			
	8	Allocate bits 8 to 11 to BANK_SEL1.																																			
	9	Allocate bits 9 to 12 to BANK_SEL1.																																			
	A	Allocate bits 10 to 13 to BANK_SEL1.																																			
	B	Allocate bits 11 to 14 to BANK_SEL1.																																			
	C	Allocate bits 12 to 15 to BANK_SEL1.																																			
		n.□□X□	<table border="1"> <thead> <tr> <th colspan="2">BANK_SEL1 Allocation Enable/Disable Selection</th> </tr> </thead> <tbody> <tr><td>0</td><td>Disable BANK_SEL1 allocation.</td></tr> <tr><td>1</td><td>Enable BANK_SEL1 allocation.</td></tr> </tbody> </table>							BANK_SEL1 Allocation Enable/Disable Selection		0	Disable BANK_SEL1 allocation.	1	Enable BANK_SEL1 allocation.																						
	BANK_SEL1 Allocation Enable/Disable Selection																																				
	0	Disable BANK_SEL1 allocation.																																			
	1	Enable BANK_SEL1 allocation.																																			
	n.□X□□	<table border="1"> <thead> <tr> <th colspan="2">LT_DISABLE Allocation (Option)</th> </tr> </thead> <tbody> <tr><td>0 to F</td><td>The settings are the same as for the V_PPI allocations.</td></tr> </tbody> </table>							LT_DISABLE Allocation (Option)		0 to F	The settings are the same as for the V_PPI allocations.																									
LT_DISABLE Allocation (Option)																																					
0 to F	The settings are the same as for the V_PPI allocations.																																				
	n.X□□□	<table border="1"> <thead> <tr> <th colspan="2">LT_DISABLE Allocation Enable/Disable Selection</th> </tr> </thead> <tbody> <tr><td>0</td><td>Disable LT_DISABLE allocation.</td></tr> <tr><td>1</td><td>Enable LT_DISABLE allocation.</td></tr> </tbody> </table>							LT_DISABLE Allocation Enable/Disable Selection		0	Disable LT_DISABLE allocation.	1	Enable LT_DISABLE allocation.																							
LT_DISABLE Allocation Enable/Disable Selection																																					
0	Disable LT_DISABLE allocation.																																				
1	Enable LT_DISABLE allocation.																																				

Continued on next page.



11.1 List of Servo Parameters

11.1.2 List of Servo Parameters

Continued from previous page.

Parameter No.	Size	Name	Setting Range	Setting Unit	Default Setting	Applicable Motors	When Enabled	Classification	Reference	
Pn82E M2 <sup>*13</sup>	2	Option Field Allocations 5	0000h to 1D1Fh	-	0000h	All	After restart	Setup	*12	
		n.□□□X	Reserved parameter (Do not change.)							
		n.□□X□	Reserved parameter (Do not change.)							
		n.□X□□	OUT_SIGNAL Allocation (Option)							
			0	Allocate bits 0 to 2 to OUT_SIGNAL.						
			1	Allocate bits 1 to 3 to OUT_SIGNAL.						
			2	Allocate bits 2 to 4 to OUT_SIGNAL.						
			3	Allocate bits 3 to 5 to OUT_SIGNAL.						
			4	Allocate bits 4 to 6 to OUT_SIGNAL.						
			5	Allocate bits 5 to 7 to OUT_SIGNAL.						
			6	Allocate bits 6 to 8 to OUT_SIGNAL.						
			7	Allocate bits 7 to 9 to OUT_SIGNAL.						
			8	Allocate bits 8 to 10 to OUT_SIGNAL.						
		9	Allocate bits 9 to 11 to OUT_SIGNAL.							
		A	Allocate bits 10 to 12 to OUT_SIGNAL.							
	B	Allocate bits 11 to 13 to OUT_SIGNAL.								
	C	Allocate bits 12 to 14 to OUT_SIGNAL.								
	D	Allocate bits 13 to 15 to OUT_SIGNAL.								
	n.X□□□	OUT_SIGNAL Allocation Enable/Disable Selection								
		0	Disable OUT_SIGNAL allocation.							
		1	Enable OUT_SIGNAL allocation.							
Pn833	2	Motion Settings	0000h to 0001h	-	0000h	All	After restart	Setup	*1	
		n.□□□X	Linear Acceleration/Deceleration Constant Selection							
			0	Use Pn80A to Pn80F and Pn827. (The settings of Pn834 to Pn840 are ignored.)						
			1	Use Pn834 to Pn840. (The settings of Pn80A to Pn80F and Pn827 are ignored.)						
		n.□□X□	Reserved parameter (Do not change.)							
		n.□X□□	Reserved parameter (Do not change.)							
	n.X□□□	Reserved parameter (Do not change.)								
Pn834	4	First Stage Linear Acceleration Constant 2	1 to 20,971,520	10,000 reference units/s <sup>2</sup>	100	All	Immediately <sup>*10</sup>	Setup	*1	
Pn836	4	Second Stage Linear Acceleration Constant 2	1 to 20,971,520	10,000 reference units/s <sup>2</sup>	100	All	Immediately <sup>*10</sup>	Setup	*1	
Pn838	4	Acceleration Constant Switching Speed 2	0 to 2,097,152,000	1 reference unit/s	0	All	Immediately <sup>*10</sup>	Setup	*1	
Pn83A	4	First Stage Linear Deceleration Constant 2	1 to 20,971,520	10,000 reference units/s <sup>2</sup>	100	All	Immediately <sup>*10</sup>	Setup	*1	

Continued on next page.

Continued from previous page.

Parameter No.	Size	Name	Setting Range	Setting Unit	Default Setting	Applicable Motors	When Enabled	Classification	Reference																				
Pn83C	4	Second Stage Linear Deceleration Constant 2	1 to 20,971,520	10,000 reference units/s <sup>2</sup>	100	All	Immediately *10	Setup	*1																				
Pn83E	4	Deceleration Constant Switching Speed 2	0 to 2,097,152,000	1 reference unit/s	0	All	Immediately *10	Setup	*1																				
Pn840	4	Linear Deceleration Constant 2 for Stopping	1 to 20,971,520	10,000 reference units/s <sup>2</sup>	100	All	Immediately *10	Setup	*1																				
Pn842 *14	4	Second Origin Approach Speed 1	0 to 20,971,520	100 reference units/s	0	All	Immediately *10	Setup	*1																				
Pn844 *15	4	Second Origin Approach Speed 2	0 to 20,971,520	100 reference units/s	0	All	Immediately *10	Setup	*1																				
Pn846	2	POSING Command Scurve Acceleration/Deceleration Rate	0 to 50	1%	0	All	Immediately *10	Setup	–																				
Pn850	2	Number of Latch Sequences	0 to 8	–	0	All	Immediately	Setup	*1																				
Pn851	2	Continuous Latch Sequence Count	0 to 255	–	0	All	Immediately	Setup	*1																				
Pn852	2	Latch Sequence 1 to 4 Settings	0000h to 3333h	–	0000h	All	Immediately	Setup	*1																				
	<table border="1"> <thead> <tr> <th colspan="2">n.□□□X</th> <th colspan="2">Latch Sequence 1 Signal Selection</th> </tr> </thead> <tbody> <tr> <td>0</td> <td>Phase C</td> <td></td> <td></td> </tr> <tr> <td>1</td> <td>EXT1 signal</td> <td></td> <td></td> </tr> <tr> <td>2</td> <td>EXT2 signal</td> <td></td> <td></td> </tr> <tr> <td>3</td> <td>EXT3 signal</td> <td></td> <td></td> </tr> </tbody> </table>									n.□□□X		Latch Sequence 1 Signal Selection		0	Phase C			1	EXT1 signal			2	EXT2 signal			3	EXT3 signal		
	n.□□□X		Latch Sequence 1 Signal Selection																										
	0	Phase C																											
	1	EXT1 signal																											
2	EXT2 signal																												
3	EXT3 signal																												
<table border="1"> <thead> <tr> <th colspan="2">n.□□X□</th> <th colspan="2">Latch Sequence 2 Signal Selection</th> </tr> </thead> <tbody> <tr> <td>0 to 3</td> <td colspan="3">The settings are the same as those for the Latch Sequence 1 Signal Selection.</td> </tr> </tbody> </table>									n.□□X□		Latch Sequence 2 Signal Selection		0 to 3	The settings are the same as those for the Latch Sequence 1 Signal Selection.															
n.□□X□		Latch Sequence 2 Signal Selection																											
0 to 3	The settings are the same as those for the Latch Sequence 1 Signal Selection.																												
<table border="1"> <thead> <tr> <th colspan="2">n.□X□□</th> <th colspan="2">Latch Sequence 3 Signal Selection</th> </tr> </thead> <tbody> <tr> <td>0 to 3</td> <td colspan="3">The settings are the same as those for the Latch Sequence 1 Signal Selection.</td> </tr> </tbody> </table>									n.□X□□		Latch Sequence 3 Signal Selection		0 to 3	The settings are the same as those for the Latch Sequence 1 Signal Selection.															
n.□X□□		Latch Sequence 3 Signal Selection																											
0 to 3	The settings are the same as those for the Latch Sequence 1 Signal Selection.																												
<table border="1"> <thead> <tr> <th colspan="2">n.X□□□</th> <th colspan="2">Latch Sequence 4 Signal Selection</th> </tr> </thead> <tbody> <tr> <td>0 to 3</td> <td colspan="3">The settings are the same as those for the Latch Sequence 1 Signal Selection.</td> </tr> </tbody> </table>									n.X□□□		Latch Sequence 4 Signal Selection		0 to 3	The settings are the same as those for the Latch Sequence 1 Signal Selection.															
n.X□□□		Latch Sequence 4 Signal Selection																											
0 to 3	The settings are the same as those for the Latch Sequence 1 Signal Selection.																												

Continued on next page.

11.1 List of Servo Parameters

11.1.2 List of Servo Parameters

Continued from previous page.

Parameter No.	Size	Name	Setting Range	Setting Unit	Default Setting	Applicable Motors	When Enabled	Classification	Reference	
Pn853	2	Latch Sequence 5 to 8 Settings	0000h to 3333h	-	0000h	All	Immediately	Setup	*1	
	n.□□□X	<b>Latch Sequence 5 Signal Selection</b>								
		0	Phase C							
		1	EXT1 signal							
		2	EXT2 signal							
	n.□□□□	<b>Latch Sequence 6 Signal Selection</b>								
		0 to 3	The settings are the same as those for the Latch Sequence 5 Signal Selection.							
	n.□X□□	<b>Latch Sequence 7 Signal Selection</b>								
		0 to 3	The settings are the same as those for the Latch Sequence 5 Signal Selection.							
	n.X□□□	<b>Latch Sequence 8 Signal Selection</b>								
0 to 3		The settings are the same as those for the Latch Sequence 5 Signal Selection.								
Pn860 M3*8	2	SVCMD_IO Input Signal Monitor Allocations 1	0000h to 1717h	-	0000h	All	Immediately	Setup	*1	
	n.□□□X	<b>Input Signal Monitor Allocation for CN1-3 (SVCMD_IO)</b>								
		0	Allocate bit 24 (IO_STS1) to CN1-3 input signal monitor.							
		1	Allocate bit 25 (IO_STS2) to CN1-3 input signal monitor.							
		2	Allocate bit 26 (IO_STS3) to CN1-3 input signal monitor.							
		3	Allocate bit 27 (IO_STS4) to CN1-3 input signal monitor.							
		4	Allocate bit 28 (IO_STS5) to CN1-3 input signal monitor.							
		5	Allocate bit 29 (IO_STS6) to CN1-3 input signal monitor.							
		6	Allocate bit 30 (IO_STS7) to CN1-3 input signal monitor.							
	n.□□□□	<b>CN1-3 Input Signal Monitor Enable/Disable Selection</b>								
0		Disable allocation for CN1-3 input signal monitor.								
n.□X□□	<b>Input Signal Monitor Allocation for CN1-4 (SVCMD_IO)</b>									
	0 to 7	The settings are the same as the CN1-3 allocations.								
n.X□□□	<b>CN1-4 Input Signal Monitor Enable/Disable Selection</b>									
	0	Disable allocation for CN1-4 input signal monitor.								
		1	Enable allocation for CN1-4 input signal monitor.							

Continued on next page.

Continued from previous page.

Parameter No.	Size	Name	Setting Range	Setting Unit	Default Setting	Applicable Motors	When Enabled	Classification	Reference
Pn861 M3*8	2	SVCMD_IO Input Signal Monitor Allocations 2	0000h to 1717h	-	0000h	All	Immediately	Setup	*1
	n.□□□X	Input Signal Monitor Allocation for CN1-5 (SVCMD_IO)							
		0 to 7	The settings are the same as the CN1-3 allocations.						
	n.□□X□	CN1-5 Input Signal Monitor Enable/Disable Selection							
		0	Disable allocation for CN1-5 input signal monitor.						
		1	Enable allocation for CN1-5 input signal monitor.						
	n.□X□□	Input Signal Monitor Allocation for CN1-6 (SVCMD_IO)							
		0 to 7	The settings are the same as the CN1-3 allocations.						
	n.X□□□	CN1-6 Input Signal Monitor Enable/Disable Selection							
		0	Disable allocation for CN1-6 input signal monitor.						
	1	Enable allocation for CN1-6 input signal monitor.							
Pn862 M3*8	2	SVCMD_IO Input Signal Monitor Allocations 3	0000h to 1717h	-	0000h	All	Immediately	Setup	*1
	n.□□□X	Input Signal Monitor Allocation for CN1-7 (SVCMD_IO)							
		0 to 7	The settings are the same as the CN1-3 allocations.						
	n.□□X□	CN1-7 Input Signal Monitor Enable/Disable Selection							
		0	Disable allocation for CN1-7 input signal monitor.						
		1	Enable allocation for CN1-7 input signal monitor.						
	n.□X□□	Input Signal Monitor Allocation for CN1-8 (SVCMD_IO)							
		0 to 7	The settings are the same as the CN1-3 allocations.						
	n.X□□□	CN1-8 Input Signal Monitor Enable/Disable Selection							
		0	Disable allocation for CN1-8 input signal monitor.						
	1	Enable allocation for CN1-8 input signal monitor.							
Pn863 M3*8	2	SVCMD_IO Input Signal Monitor Allocations 4	0000h to 1717h	-	0000h	All	Immediately	Setup	*1
	n.□□□X	Input Signal Monitor Allocation for CN1-9 (SVCMD_IO)							
		0 to 7	The settings are the same as the CN1-3 allocations.						
	n.□□X□	CN1-9 Input Signal Monitor Enable/Disable Selection							
		0	Disable allocation for CN1-9 input signal monitor.						
		1	Enable allocation for CN1-9 input signal monitor.						
	n.□X□□	Input Signal Monitor Allocation for CN1-10 (SVCMD_IO)							
		0 to 7	The settings are the same as the CN1-3 allocations.						
	n.X□□□	CN1-10 Input Signal Monitor Enable/Disable Selection							
		0	Disable allocation for CN1-10 input signal monitor.						
	1	Enable allocation for CN1-10 input signal monitor.							

Continued on next page.

11.1 List of Servo Parameters

11.1.2 List of Servo Parameters

Continued from previous page.

Parameter No.	Size	Name	Setting Range	Setting Unit	Default Setting	Applicable Motors	When Enabled	Classification	Reference	
Pn864 M3*§	2	SVCMD_IO Input Signal Monitor Allocations 5	0000h to 1717h	-	0000h	All	Immediately	Setup	*1	
	n.□□□X		Input Signal Monitor Allocation for CN1-11 (SVCMD_IO)							
			0 to 7	The settings are the same as the CN1-3 allocations.						
	n.□□X□		CN1-11 Input Signal Monitor Enable/Disable Selection							
			0	Disable allocation for CN1-11 input signal monitor.						
			1	Enable allocation for CN1-11 input signal monitor.						
	n.□X□□		Input Signal Monitor Allocation for CN1-12 (SVCMD_IO)							
			0 to 7	The settings are the same as the CN1-3 allocations.						
	n.X□□□		CN1-12 Input Signal Monitor Enable/Disable Selection							
			0	Disable allocation for CN1-12 input signal monitor.						
			1	Enable allocation for CN1-12 input signal monitor.						
	Pn865 M3*§	2	SVCMD_IO Input Signal Monitor Allocations 6	0000h to 1717h	-	0000h	All	Immediately	Setup	*1
n.□□□X		Input Signal Monitor Allocation for CN1-13 (SVCMD_IO)								
		0 to 7	The settings are the same as the CN1-3 allocations.							
n.□□X□		CN1-13 Input Signal Monitor Enable/Disable Selection								
		0	Disable allocation for CN1-13 input signal monitor.							
		1	Enable allocation for CN1-13 input signal monitor.							
n.□X□□		Input Signal Monitor Allocation for CN1-14 (SVCMD_IO)								
		0 to 7	The settings are the same as the CN1-3 allocations.							
n.X□□□		CN1-14 Input Signal Monitor Enable/Disable Selection								
		0	Disable allocation for CN1-14 input signal monitor.							
		1	Enable allocation for CN1-14 input signal monitor.							

Continued on next page.

Continued from previous page.

Parameter No.	Size	Name	Setting Range	Setting Unit	Default Setting	Applicable Motors	When Enabled	Classification	Reference		
Pn868 M3*8	2	SVCMD_IO Output Signal Monitor Allocations 1	0000h to 1717h	-	0000h	All	Immediately	Setup	*1		
			<b>Output Signal Monitor Allocation for CN1-23 and CN1-24 (SVCMD_IO)</b>								
	n.□□□X		0	Allocate bit 24 (IO_STS1) to CN1-23/CN1-24 output signal monitor.							
			1	Allocate bit 25 (IO_STS2) to CN1-23/CN1-24 output signal monitor.							
			2	Allocate bit 26 (IO_STS3) to CN1-23/CN1-24 output signal monitor.							
			3	Allocate bit 27 (IO_STS4) to CN1-23/CN1-24 output signal monitor.							
			4	Allocate bit 28 (IO_STS5) to CN1-23/CN1-24 output signal monitor.							
			5	Allocate bit 29 (IO_STS6) to CN1-23/CN1-24 output signal monitor.							
			6	Allocate bit 30 (IO_STS7) to CN1-23/CN1-24 output signal monitor.							
			7	Allocate bit 31 (IO_STS8) to CN1-23/CN1-24 output signal monitor.							
			<b>CN1-23/CN1-24 Output Signal Monitor Enable/Disable Selection</b>								
	n.□□X□		0	Disable allocation for CN1-23/CN1-24 output signal monitor.							
			1	Enable allocation for CN1-23/CN1-24 output signal monitor.							
			<b>Output Signal Monitor Allocation for CN1-25 and CN1-26 (SVCMD_IO)</b>								
	n.□X□□		0 to 7	The settings are the same as the CN1-23/CN1-24 allocations.							
		<b>CN1-25/CN1-26 Output Signal Monitor Enable/Disable Selection</b>									
n.X□□□		0	Disable allocation for CN1-25/CN1-26 output signal monitor.								
		1	Enable allocation for CN1-25/CN1-26 output signal monitor.								
Pn869 M3*8	2	SVCMD_IO Output Signal Monitor Allocations 2	0000h to 1717h	-	0000h	All	Immediately	Setup	*1		
			<b>Output Signal Monitor Allocation for CN1-27 and CN1-28 (SVCMD_IO)</b>								
	n.□□□X		0 to 7	The settings are the same as the CN1-23/CN1-24 allocations.							
			<b>CN1-27/CN1-28 Output Signal Monitor Enable/Disable Selection</b>								
	n.□□X□		0	Disable allocation for CN1-27/CN1-28 output signal monitor.							
			1	Enable allocation for CN1-27/CN1-28 output signal monitor.							
			<b>Output Signal Monitor Allocation for CN1-29 and CN1-30 (SVCMD_IO)</b>								
	n.□X□□		0 to 7	The settings are the same as the CN1-23/CN1-24 allocations.							
			<b>CN1-29/CN1-30 Output Signal Monitor Enable/Disable Selection</b>								
	n.X□□□		0	Disable allocation for CN1-29/CN1-30 output signal monitor.							
			1	Enable allocation for CN1-29/CN1-30 output signal monitor.							
	Pn86A M3*8	2	SVCMD_IO Output Signal Monitor Allocations 3	0000h to 1717h	-	0000h	All	Immediately	Setup	*1	
				<b>Output Signal Monitor Allocation for CN1-31 and CN1-32 (SVCMD_IO)</b>							
		n.□□□X		0 to 7	The settings are the same as the CN1-23/CN1-24 allocations.						
				<b>CN1-31/CN1-32 Output Signal Monitor Enable/Disable Selection</b>							
n.□□X□		0	Disable allocation for CN1-31/CN1-32 output signal monitor.								
		1	Enable allocation for CN1-31/CN1-32 output signal monitor.								
		<b>Reserved parameter (Do not change.)</b>									
n.□X□□											
		<b>Reserved parameter (Do not change.)</b>									
n.X□□□											

Continued on next page.

11.1 List of Servo Parameters

11.1.2 List of Servo Parameters

Continued from previous page.

Parameter No.	Size	Name	Setting Range	Setting Unit	Default Setting	Applicable Motors	When Enabled	Classification	Reference	
Pn880	2	Station Address Monitor (for maintenance, read only)	03h to EFh	-	-	All	-	Setup	page 5-11	
Pn881	2	Set Transmission Byte Count Monitor [bytes] (for maintenance, read only)	17, 32, 48	-	-	All	-	Setup	page 5-11	
Pn882	2	Transmission Cycle Setting Monitor [ $\times 0.25 \mu\text{s}$ ] (for maintenance, read only)	0h to FFFFh	-	-	All	-	Setup	page 5-11	
Pn883	2	Communications Cycle Setting Monitor [transmission cycles] (for maintenance, read only)	0 to 32	-	-	All	-	Setup	page 5-11	
Pn884 M3*8	2	Communications Controls 2	0000h to 0001h	-	0000h	All	Immediately	Setup	*1	
	MECHATROLINK Communications Error Holding Brake Signal Setting									
	n.□□□X	0	Maintain the status set by the BRK_ON or BRK_OFF command when a MECHATROLINK communications error occurs.							
	n.□□□X	1	Apply the holding brake when a MECHATROLINK communications error occurs.							
	n.□□□□	Reserved parameter (Do not change.)								
	n.□X□□	Reserved parameter (Do not change.)								
n.X□□□	Reserved parameter (Do not change.)									
Pn88A	2	MECHATROLINK Receive Error Counter Monitor (for maintenance, read only)	0 to 65,535	-	0	All	-	Setup	-	
Pn890 to Pn8A6	4	Command Data Monitor during Alarm/Warning (for maintenance, read only)	0h to FFFFFFFFh	-	0h	All	-	Setup	*1	
Pn8A8 to Pn8BE	4	Response Data Monitor during Alarm/Warning (for maintenance, read only)	0h to FFFFFFFFh	-	0h	All	-	Setup	*1	
Pn900	2	Number of Parameter Banks	0 to 16	-	0	All	After restart	Setup	*1	
Pn901	2	Number of Parameter Bank Members	0 to 15	-	0	All	After restart	Setup	*1	
Pn902 to Pn910	2	Parameter Bank Member Definition	0000h to 08FFh	-	0000h	All	After restart	Setup	*1	
Pn920 to Pn95F	2	Parameter Bank Data (Not saved in nonvolatile memory.)	0000h to FFFFh	-	0000h	All	Immediately	Setup	*1	

- \*1. Refer to the following manual for details.  
 $\Sigma$ -7-Series MECHATROLINK-III Communications Standard Servo Profile Command Manual (Manual No.: SIEP S800001 31)
- \*2. Set a percentage of the motor rated torque.
- \*3. Normally set this parameter to 0. If you use an External Regenerative Resistor, set the capacity (W) of the External Regenerative Resistor.
- \*4. The upper limit is two times the maximum output capacity (W) of the SERVOPACK.
- \*5. These parameters are for SERVOPACKs with the dynamic brake option. Refer to the following manual for details.  
 $\Sigma$ -7-Series  $\Sigma$ -7S/ $\Sigma$ -7W SERVOPACK with Dynamic Brake Hardware Option Specifications Product Manual (Manual No.: SIEP S800001 73)
- \*6. The SGLFW2 is the only Yaskawa Linear Servomotor that supports this function.
- \*7. Enabled only when Pn61A is set to n.□□□2 or n.□□□3.
- \*8. This parameter is valid only when the MECHATROLINK-III standard servo profile is used.
- \*9. The parameter setting is enabled after SENS\_ON command execution is completed.
- \*10. Change the setting when the reference is stopped (i.e., while DEN is set to 1). If you change the setting during operation, the reference output will be affected.

\*11.The settings are updated only if the reference is stopped (i.e., only if DEN is set to 1).

\*12.Refer to the following manual for details.

  $\Sigma$ -7-Series MECHATROLINK-II Communications Command Manual (Manual No.: SIEP S800001 30)

\*13.This parameter is valid only when the MECHATROLINK-II-compatible profile is used.

\*14.The setting of Pn842 is valid while Pn817 is set to 0.

\*15.The setting of Pn844 is valid while Pn818 is set to 0.



# 11.2 List of MECHATROLINK-III Common Parameters

## 11.2.1 Interpreting the Parameter Lists

The types of motors to which the parameter applies.

- All: The parameter is used for both Rotary Servomotors and Linear Servomotors.
- Rotary: The parameter is used for only Rotary Servomotors.
- Linear: The parameter is used for only Linear Servomotors.

Rotary Servomotor terms are used for parameters that are applicable to all Servomotors. If you are using a Linear Servomotor, you need to interpret the terms accordingly. Refer to the following section for details.

 **Differences in Terms for Rotary Servomotors and Linear Servomotors on page x**

Indicates when a change to the parameter will be effective.

“After restart” indicates parameters that will be effective after one of the following is executed.

- The power supply is turned OFF and ON again.
- The CONFIG command is sent.
- A software reset is executed.

Parameter No.	Size	Name	Setting Range	Setting Unit [Resolution]	Default Setting	Applicable Motors	When Enabled	Classification
61 PnAC2	4	Speed Loop Gain	1,000 to 2,000,000	0.001 Hz [0.1 Hz]	40000	All	Immediately	Tuning

You can set the parameter in increments of the setting unit. However, if a unit is given in square brackets, the setting is automatically converted to the resolution given in the square brackets.

## 11.2.2 List of MECHATROLINK-III Common Parameters

The following table lists the common MECHATROLINK-III parameters. These common parameters are used to make settings from the host controller via MECHATROLINK communications. Do not change the settings with the Digital Operator or any other device.

Parameter No.	Size	Name	Setting Range	Setting Unit [Resolution]	Default Setting	Applicable Motors	When Enabled	Classification
01 PnA02	4	Encoder Type Selection (read only)	0h, 1h	-	-	All	-	Device information
		0000h	Absolute encoder					
		0001h	Incremental encoder					
02 PnA04	4	Motor Type Selection (read only)	0h, 1h	-	-	All	-	
		0000h	Rotary Servomotor					
		0001h	Linear Servomotor					
04 PnA08	4	Rated Motor Speed (read only)	0h to FFFFFFFh	1 min <sup>-1</sup>	-	All	-	
05 PnA0A	4	Maximum Output Speed (read only)	0h to FFFFFFFh	1 min <sup>-1</sup>	-	All	-	

Continued on next page.

Continued from previous page.

Parameter No.	Size	Name	Setting Range	Setting Unit [Resolution]	Default Setting	Applicable Motors	When Enabled	Classification	
06 PnA0C	4	Speed Multiplier (read only)	-1,073,741,823 to 1,073,741,823	-	-	All	-	Device information	
07 PnA0E	4	Rated Torque (read only)	0h to FFFFFFFh	1 N·m	-	All	-		
08 PnA10	4	Maximum Output Torque (read only)	0h to FFFFFFFh	1 N·m	-	All	-		
09 PnA12	4	Torque Multiplier (read only)	-1,073,741,823 to 1,073,741,823	-	-	All	-		
0A PnA14	4	Resolution (read only)	0h to FFFFFFFh	1 pulse/rev	-	Rotary	-		
0B PnA16	4	Scale Pitch	0 to 65,536,000	1 nm [0.01 μm]	0	Linear	After restart*1		
0C PnA18	4	Pulses per Scale Pitch (read only)	0h to FFFFFFFh	1 pulse/pitch	-	Linear	-		
21 PnA42	4	Electronic Gear Ratio (Numerator)	1 to 1,073,741,824	-	16	All	After restart	Machine specifications	
22 PnA44	4	Electronic Gear Ratio (Denominator)	1 to 1,073,741,824	-	1	All	After restart		
23 PnA46	4	Absolute Encoder Origin Offset	-1,073,741,823 to 1,073,741,823	1 reference unit	0	All	Immediately*1		
24 PnA48	4	Multiturn Limit Setting	0 to 65,535	1 Rev	65535	Rotary	After restart		
25 PnA4A	4	Limit Setting	0h to 33h	-	0h	All	After restart		
		Bit 0	P-OT (0: Enabled, 1: Disabled)						
		Bit 1	N-OT (0: Enabled, 1: Disabled)						
		Bit 2	Reserved.						
		Bit 3	Reserved.						
		Bit 4	P-SOT (0: Disabled, 1: Enabled)						
		Bit 5	N-SOT (0: Disabled, 1: Enabled)						
Bits 6 to 31	Reserved.								
26 PnA4C	4	Forward Software Limit	-1,073,741,823 to 1,073,741,823	1 reference unit	1073741823	All	Immediately		
27 PnA4E	4	Reserved parameter (Do not change.)	-	-	0	All	Immediately		
28 PnA50	4	Reverse Software Limit	-1,073,741,823 to 1,073,741,823	1 reference unit	-1073741823	All	Immediately		
29 PnA52	4	Reserved parameter (Do not change.)	-	-	0	All	Immediately		
41 PnA82	4	Speed Unit Selection	0h to 4h	-	0h	All	After restart		
		0000h	Reference units/s						
		0001h	Reference units/min						
		0002h	Percentage (%) of rated speed*2						
		0003h	min <sup>-1+2</sup>						
		0004h	Maximum motor speed/4000000h*3						
Continued on next page.									

11.2 List of MECHATROLINK-III Common Parameters

11.2.2 List of MECHATROLINK-III Common Parameters

Continued from previous page.

Parameter No.	Size	Name	Setting Range	Setting Unit [Resolution]	Default Setting	Applicable Motors	When Enabled	Classification	
42 PnA84	4	Speed Base Unit Selection <sup>*2, *3</sup> (Set the value of n from the following formula: Speed unit selection (41 PnA82) × 10 <sup>n</sup> )	-3 to 3	-	0	All	After restart	Unit settings	
43 PnA86	4	Position Unit Selection	0h	-	0h	All	After restart		
		0000h    Reference units							
44 PnA88	4	Position Base Unit Selection (Set the value of n from the following formula: Position unit selection (43 PnA86) × 10 <sup>n</sup> )	0	-	0	All	After restart		
45 PnA8A	4	Acceleration Unit Selection	0h	-	0h	All	After restart		
		0000h    Reference units/s <sup>2</sup>							
46 PnA8C	4	Acceleration Base Unit Selection (Set the value of n from the following formula: Acceleration unit selection (45 PnA8A) × 10 <sup>n</sup> )	4 to 6	-	4	All	After restart		
47 PnA8E	4	Torque Unit Selection	1h, 2h	-	1h	All	After restart		
		0001h    Percentage (%) of rated torque							
		0002h    Maximum torque/40000000h <sup>*4</sup>							
48 PnA90	4	Torque Base Unit Selection <sup>*4</sup> (Set the value of n from the following formula: Torque unit selection (47 PnA8E) × 10 <sup>n</sup> )	-5 to 0	-	0	All	After restart		

Continued on next page.

Continued from previous page.

Parameter No.	Size	Name	Setting Range	Setting Unit [Resolution]	Default Setting	Applicable Motors	When Enabled	Classification		
49 PnA92	4	Supported Unit Systems (read only)	-	-	0601011Fh	All	-	Unit settings		
		<b>Speed Units</b>								
		Bit 0	Reference units/s (1: Enabled)							
		Bit 1	Reference units/min (1: Enabled)							
		Bit 2	Percentage (%) of rated speed (1: Enabled)							
		Bit 3	min <sup>-1</sup> (rpm) (1: Enabled)							
		Bit 4	Maximum motor speed/4000000h (1: Enabled)							
		Bits 5 to 7	Reserved (0: Disabled).							
		<b>Position Units</b>								
		Bit 8	Reference units (1: Enabled)							
		Bits 9 to 15	Reserved (0: Disabled).							
		<b>Acceleration Units</b>								
		Bit 16	Reference units/s <sup>2</sup> (1: Enabled)							
		Bit 17	ms (acceleration time required to reach rated speed) (0: Disabled)							
		Bits 18 to 23	Reserved (0: Disabled).							
		<b>Torque Units</b>								
		Bit 24	N·m (0: Disabled)							
Bit 25	Percentage (%) of rated torque (1: Enabled)									
Bit 26	Maximum torque/40000000h									
Bits 27 to 31	Reserved (0: Disabled).									
61 PnAC2	4	Speed Loop Gain	1,000 to 2,000,000	0.001 Hz [0.1 Hz]	40000	All	Immediately	Tuning		
62 PnAC4	4	Speed Loop Integral Time Constant	150 to 512,000	1 μs [0.01 ms]	20000	All	Immediately			
63 PnAC6	4	Position Loop Gain	1,000 to 2,000,000	0.001/s [0.1/s]	40000	All	Immediately			
64 PnAC8	4	Feedforward Compensation	0 to 100	1%	0	All	Immediately			
65 PnACA	4	Position Loop Integral Time Constant	0 to 5,000,000	1 μs [0.1 ms]	0	All	Immediately			
66 PnACC	4	Positioning Completed Width	0 to 1,073,741,824	1 reference unit	7	All	Immediately			
67 PnACE	4	Near Signal Width	1 to 1,073,741,824	1 reference unit	1073741824	All	Immediately			
81 PnB02	4	Exponential Acceleration/Deceleration Time Constant	0 to 510,000	1 μs [0.1 ms]	0	All	Immediately* <sup>s</sup>			
82 PnB04	4	Average Movement Time	0 to 510,000	1 μs [0.1 ms]	0	All	Immediately* <sup>s</sup>			
83 PnB06	4	External Positioning Final Travel Distance	-1,073,741,823 to 1,073,741,823	1 reference unit	100	All	Immediately			
84 PnB08	4	Origin Approach Speed	0h to 3FFFFFFFh	10 <sup>-3</sup> min <sup>-1</sup>	× 5,000h reference units/s converted to 10 <sup>-3</sup> min <sup>-1</sup>	All	Immediately			
85 PnB0A	4	Origin Return Creep Speed	0h to 3FFFFFFFh	10 <sup>-3</sup> min <sup>-1</sup>	× 500h reference units/s converted to 10 <sup>-3</sup> min <sup>-1</sup>	All	Immediately			

Continued on next page.

11.2 List of MECHATROLINK-III Common Parameters

11.2.2 List of MECHATROLINK-III Common Parameters

Continued from previous page.

Parameter No.	Size	Name	Setting Range	Setting Unit [Resolution]	Default Setting	Applicable Motors	When Enabled	Classification
86 PnB0C	4	Final Travel Distance for Origin Return	-1,073,741,823 to 1,073,741,823	1 reference unit	100	All	Immediately	Tuning
87 PnB0E	4	Fixed Monitor Selection 1	0h to Fh	-	1h	All	Immediately	
	0000h	APOS						
	0001h	CPOS						
	0002h	PERR						
	0003h	LPOS1						
	0004h	LPOS2						
	0005h	FSPD						
	0006h	CSPD						
	0007h	TRQ						
	0008h	ALARM						
	0009h	MPOS						
	000Ah	Reserved (undefined value).						
	000Bh	Reserved (undefined value).						
	000Ch	CMN1 (common monitor 1)						
	000Dh	CMN2 (common monitor 2)						
	000Eh	OMN1 (optional monitor 1)						
000Fh	OMN2 (optional monitor 2)							

Continued on next page.

Continued from previous page.

Parameter No.	Size	Name	Setting Range	Setting Unit [Resolution]	Default Setting	Applicable Motors	When Enabled	Classification			
88 PnB10	4	Fixed Monitor Selection 2	0h to Fh	–	0h	All	Immediately				
		0000 to 000Fh	The settings are the same as those for Fixed Monitor Selection 1.								
89 PnB12	4	SEL_MON (CMN1) Monitor Selection 1	0h to 9h	–	0h	All	Immediately	Command-related parameters			
		0000h	TPOS (target position in reference coordinate system)								
		0001h	IPOS (reference position in reference coordinate system)								
		0002h	POS_OFFSET (offset set in POS_SET (Set Coordinate System) command)								
		0003h	TSPD (target speed)								
		0004h	SPD_LIM (speed limit)								
		0005h	TRQ_LIM (torque limit)								
		0006h	SV_STAT (servo actual operating status) Monitor Description Byte 1: Current communications phase 00h: Phase 0 01h: Phase 1 02h: Phase 2 03h: Phase 3 Byte 2: Current control mode 00h: Position control mode 01h: Speed control mode 02h: Torque control mode Byte 3: Reserved Byte 4: Expansion signal monitor								
			Bit 0	LT_RDY1	Processing status for latch detection for LT_REQ1 in SVCM-D_CTRL region	0	Latch detection not yet processed.				
						1	Processing latch detection in progress.				
			Bit 1	LT_RDY1	Processing status for latch detection for LT_REQ2 in SVCM-D_CTRL region	0	Latch detection not yet processed.				
						1	Processing latch detection in progress.				
			Bits 2 and 3	LT_SEL1R	Latch signal	0	Phase C				
						1	External input signal 1				
						2	External input signal 2				
Bits 4 and 5	LT_SEL2R		Latch signal	0	Phase C						
				1	External input signal 1						
		2		External input signal 2							
Bit 6	Reserved (0).										
0007h	Reserved.										
0008h	INIT_PGPOS (Low)			Lower 32 bits of initial encoder position converted to 64-bit position reference data							
0009h	INIT_PGPOS (High)			Upper 32 bits of initial encoder position converted to 64-bit position reference data							

Continued on next page.

11.2 List of MECHATROLINK-III Common Parameters

11.2.2 List of MECHATROLINK-III Common Parameters

Continued from previous page.

Parameter No.	Size	Name	Setting Range	Setting Unit [Resolution]	Default Setting	Applicable Motors	When Enabled	Classification	
8A PnB14	4	SEL_MON (CMN2) Monitor Selection 2	0h to 9h	-	0h	All	Immediately	Command-related parameters	
	0000h to 0009h		The settings are the same as those for SEL_MON Monitor Selection 1.						
8B PnB16	4	Origin Detection Width	0 to 250	1 reference unit	10	All	Immediately		
8C PnB18	4	Forward Torque Limit	0 to 800	1%	100	All	Immediately		
8D PnB1A	4	Reverse Torque Limit	0 to 800	1%	100	All	Immediately		
8E PnB1C	4	Zero Speed Detection Range	1,000 to 10,000,000	10 <sup>-3</sup> min <sup>-1</sup>	20000	All	Immediately		
8F PnB1E	4	Speed Coincidence Signal Detection Width	0 to 100,000	10 <sup>-3</sup> min <sup>-1</sup>	10000	All	Immediately		
90 PnB20	4	Servo Command Control Field Enable/Disable Selections (read only)	-	-	0FFF3F3Fh	All	-		
	Bit 0		CMD_PAUSE (1: Enabled)						
	Bit 1		CMD_CANCEL (1: Enabled)						
	Bits 2 and 3		STOP_MODE (1: Enabled)						
	Bits 4 and 5		ACCFIL (1: Enabled)						
	Bits 6 and 7		Reserved (0: Disabled).						
	Bit 8		LT_REQ1 (1: Enabled)						
	Bit 9		LT_REQ2 (1: Enabled)						
	Bits 10 and 11		LT_SEL1 (1: Enabled)						
	Bits 12 and 13		LT_SEL2 (1: Enabled)						
	Bits 14 and 15		Reserved (0: Disabled).						
	Bits 16 to 19		SEL_MON1 (1: Enabled)						
	Bits 20 to 23		SEL_MON2 (1: Enabled)						
	Bits 24 to 27		SEL_MON3 (1: Enabled)						
	Bits 28 to 31		Reserved (0: Disabled).						

Continued on next page.

Continued from previous page.

Parameter No.	Size	Name	Setting Range	Setting Unit [Resolution]	Default Setting	Applicable Motors	When Enabled	Classification
91 PnB22	4	Servo Status Field Enable/Disable Selections (read only)	-	-	0FFF3F33 h	All	-	Command-related parameters
		Bit 0	CMD_PAUSE_CMP (1: Enabled)					
		Bit 1	CMD_CANCEL_CMP (1: Enabled)					
		Bit 2 and 3	Reserved (0: Disabled).					
		Bits 4 and 5	ACCFIL (1: Enabled)					
		Bits 6 and 7	Reserved (0: Disabled).					
		Bit 8	L_CMP1 (1: Enabled)					
		Bit 9	L_CMP2 (1: Enabled)					
		Bit 10	POS_RDY (1: Enabled)					
		Bit 11	PON (1: Enabled)					
		Bit 12	M_RDY (1: Enabled)					
		Bit 13	SV_ON (1: Enabled)					
		Bits 14 and 15	Reserved (0: Disabled).					
		Bits 16 to 19	SEL_MON1 (1: Enabled)					
		Bits 20 to 23	SEL_MON2 (1: Enabled)					
		Bits 24 to 27	SEL_MON3 (1: Enabled)					
Bits 28 to 31	Reserved (0: Disabled).							
92 PnB24	4	Output Bit Enable/Disable Selections (read only)	-	-	01FF01F0 h	All	-	Command-related parameters
		Bits 0 to 3	Reserved (0: Disabled).					
		Bit 4	V_PPI (1: Enabled)					
		Bit 5	P_PPI (1: Enabled)					
		Bit 6	P_CL (1: Enabled)					
		Bit 7	N_CL (1: Enabled)					
		Bit 8	G_SEL (1: Enabled)					
		Bits 9 to 11	G_SEL (0: Disabled)					
		Bits 12 to 15	Reserved (0: Disabled).					
		Bits 16 to 19	BANK_SEL (1: Enabled)					
		Bits 20 to 24	SO1 to SO5 (1: Enabled)					
		Bit 25 to 31	Reserved (0: Disabled).					

Continued on next page.



11.2 List of MECHATROLINK-III Common Parameters

11.2.2 List of MECHATROLINK-III Common Parameters

Continued from previous page.

Parameter No.	Size	Name	Setting Range	Setting Unit [Resolution]	Default Setting	Applicable Motors	When Enabled	Classification		
93 PnB26	4	Input Bit Enable/Disable Selections (read only)	-	-	FF0FFEFh	All	-	Command-related parameters		
	Bit 0		Reserved (0: Disabled).							
	Bit 1		DEC (1: Enabled)							
	Bit 2		P-OT (1: Enabled)							
	Bit 3		N-OT (1: Enabled)							
	Bit 4		EXT1 (1: Enabled)							
	Bit 5		EXT2 (1: Enabled)							
	Bit 6		EXT3 (1: Enabled)							
	Bit 7		ESTP (1: Enabled)							
	Bit 8		Reserved (0: Disabled).							
	Bit 9		BRK_ON (1: Enabled)							
	Bit 10		P-SOT (1: Enabled)							
	Bit 11		N-SOT (1: Enabled)							
	Bit 12		DEN (1: Enabled)							
	Bit 13		NEAR (1: Enabled)							
	Bit 14		PSET (1: Enabled)							
	Bit 15		ZPOINT (1: Enabled)							
	Bit 16		T_LIM (1: Enabled)							
	Bit 17		V_LIM (1: Enabled)							
	Bit 18		V_CMP (1: Enabled)							
	Bit 19		ZSPD (1: Enabled)							
Bits 20 to 23		Reserved (0: Disabled).								
Bits 24 to 31		IO_STS1 to IO_STS8 (1: Enabled)								

- \*1. The parameter setting is enabled after SENS\_ON command execution is completed.
- \*2. If you set the Speed Unit Selection (parameter 41) to either 0002h or 0003h, set the Speed Base Unit Selection (parameter 42) to a number between -3 and 0.
- \*3. If you set the Speed Unit Selection (parameter 41) to 0004h, set the Speed Base Unit Selection (parameter 42) to 0.
- \*4. If you set the Torque Unit Selection (parameter 47) to 0002h, set the Torque Base Unit Selection (parameter 48) to 0.
- \*5. Change the setting when the reference is stopped (i.e., while DEN is set to 1). If you change the setting during operation, the reference output will be affected.

## 11.3 Parameter Recording Table

Use the following table to record the settings of the parameters.

Parameter No.	Default Setting					Name	When Enabled
Pn000	0000h					Basic Function Selections 0	After restart
Pn001	0000h					Application Function Selections 1	After restart
Pn002	0011h					Application Function Selections 2	After restart
Pn006	0002h					Application Function Selections 6	Immediately
Pn007	0000h					Application Function Selections 7	Immediately
Pn008	4000h					Application Function Selections 8	After restart
Pn009	0010h					Application Function Selections 9	After restart
Pn00A	0001h					Application Function Selections A	After restart
Pn00B	0000h					Application Function Selections B	After restart
Pn00C	0000h					Application Function Selections C	After restart
Pn00D	0000h					Application Function Selections D	After restart
Pn00F	0000h					Application Function Selections F	After restart
Pn021	0000h					Reserved parameter	–
Pn022	0000h					Reserved parameter	–
Pn080	0000h					Application Function Selections 80	After restart
Pn100	400					Speed Loop Gain	Immediately
Pn101	2000					Speed Loop Integral Time Constant	Immediately
Pn102	400					Position Loop Gain	Immediately
Pn103	100					Moment of Inertia Ratio	Immediately
Pn104	400					Second Speed Loop Gain	Immediately
Pn105	2000					Second Speed Loop Integral Time Constant	Immediately
Pn106	400					Second Position Loop Gain	Immediately
Pn109	0					Feedforward	Immediately
Pn10A	0					Feedforward Filter Time Constant	Immediately
Pn10B	0000h					Gain Application Selections	*1
Pn10C	200					Mode Switching Level for Torque Reference	Immediately
Pn10D	0					Mode Switching Level for Speed Reference	Immediately
Pn10E	0					Mode Switching Level for Acceleration	Immediately
Pn10F	0					Mode Switching Level for Position Deviation	Immediately
Pn11F	0					Position Integral Time Constant	Immediately

Continued on next page.

Continued from previous page.

Parameter No.	Default Setting						Name	When Enabled
Pn121	100						Friction Compensation Gain	Immediately
Pn122	100						Second Friction Compensation Gain	Immediately
Pn123	0						Friction Compensation Coefficient	Immediately
Pn124	0						Friction Compensation Frequency Correction	Immediately
Pn125	100						Friction Compensation Gain Correction	Immediately
Pn131	0						Gain Switching Time 1	Immediately
Pn132	0						Gain Switching Time 2	Immediately
Pn135	0						Gain Switching Waiting Time 1	Immediately
Pn136	0						Gain Switching Waiting Time 2	Immediately
Pn139	0000h						Automatic Gain Switching Selections 1	Immediately
Pn13D	2000						Current Gain Level	Immediately
Pn140	0100h						Model Following Control-Related Selections	Immediately
Pn141	500						Model Following Control Gain	Immediately
Pn142	1000						Model Following Control Gain Correction	Immediately
Pn143	1000						Model Following Control Bias in the Forward Direction	Immediately
Pn144	1000						Model Following Control Bias in the Reverse Direction	Immediately
Pn145	500						Vibration Suppression 1 Frequency A	Immediately
Pn146	700						Vibration Suppression 1 Frequency B	Immediately
Pn147	1000						Model Following Control Speed Feedforward Compensation	Immediately
Pn148	500						Second Model Following Control Gain	Immediately
Pn149	1000						Second Model Following Gain Control Correction	Immediately
Pn14A	800						Vibration Suppression 2 Frequency	Immediately
Pn14B	100						Vibration Suppression 2 Correction	Immediately
Pn14F	0021h						Control-Related Selections	After restart
Pn160	0010h						Anti-Resonance Control-Related Selections	Immediately
Pn161	1000						Anti-Resonance Frequency	Immediately
Pn162	100						Anti-Resonance Gain Correction	Immediately
Pn163	0						Anti-Resonance Damping Gain	Immediately
Pn164	0						Anti-Resonance Filter Time Constant 1 Correction	Immediately

Continued on next page.

Continued from previous page.

Parameter No.	Default Setting						Name	When Enabled
Pn165	0						Anti-Resonance Filter Time Constant 2 Correction	Immediately
Pn166	0						Anti-Resonance Damping Gain 2	Immediately
Pn170	1401h						Tuning-less Function-Related Selections	*1
Pn181	0						Mode Switching Level for Speed Reference	Immediately
Pn182	0						Mode Switching Level for Acceleration	Immediately
Pn205	65535						Multiturn Limit	After restart
Pn207	0010h						Position Control Function Selections	After restart
Pn20E	16						Electronic Gear Ratio (Numerator)	After restart
Pn210	1						Electronic Gear Ratio (Denominator)	After restart
Pn230	0000h						Position Control Expansion Function Selections	After restart
Pn231	0						Backlash Compensation	Immediately
Pn233	0						Backlash Compensation Time Constant	Immediately
Pn282	0						Linear Encoder Pitch	After restart
Pn304	500						Jogging Speed	Immediately
Pn305	0						Soft Start Acceleration Time	Immediately
Pn306	0						Soft Start Deceleration Time	Immediately
Pn308	0						Speed Feedback Filter Time Constant	Immediately
Pn30A	0						Deceleration Time for Servo OFF and Forced Stops	Immediately
Pn30C	0						Speed Feedforward Average Movement Time	Immediately
Pn310	0000h						Vibration Detection Selections	Immediately
Pn311	100						Vibration Detection Sensitivity	Immediately
Pn312	50						Vibration Detection Level	Immediately
Pn316	10000						Maximum Motor Speed	After restart
Pn324	300						Moment of Inertia Calculation Starting Level	Immediately
Pn383	50						Jogging Speed	Immediately
Pn384	10						Vibration Detection Level	Immediately
Pn385	50						Maximum Motor Speed	After restart
Pn401	100						First Stage First Torque Reference Filter Time Constant	Immediately
Pn402	800						Forward Torque Limit	Immediately
Pn403	800						Reverse Torque Limit	Immediately
Pn404	100						Forward External Torque Limit	Immediately
Pn405	100						Reverse External Torque Limit	Immediately
Pn406	800						Emergency Stop Torque	Immediately

Continued on next page.

Continued from previous page.

Parameter No.	Default Setting						Name	When Enabled
Pn407	10000						Speed Limit during Torque Control	Immediately
Pn408	0000h						Torque-Related Function Selections	*1
Pn409	5000						First Stage Notch Filter Frequency	Immediately
Pn40A	70						First Stage Notch Filter Q Value	Immediately
Pn40B	0						First Stage Notch Filter Depth	Immediately
Pn40C	5000						Second Stage Notch Filter Frequency	Immediately
Pn40D	70						Second Stage Notch Filter Q Value	Immediately
Pn40E	0						Second Stage Notch Filter Depth	Immediately
Pn40F	5000						Second Stage Second Torque Reference Filter Frequency	Immediately
Pn410	50						Second Stage Second Notch Filter Q Value	Immediately
Pn412	100						First Stage Second Torque Reference Filter Time Constant	Immediately
Pn416	0000h						Torque-Related Function Selections 2	Immediately
Pn417	5000						Third Stage Notch Filter Frequency	Immediately
Pn418	70						Third Stage Notch Filter Q Value	Immediately
Pn419	0						Third Stage Notch Filter Depth	Immediately
Pn41A	5000						Fourth Stage Notch Filter Frequency	Immediately
Pn41B	70						Fourth Stage Notch Filter Q Value	Immediately
Pn41C	0						Fourth Stage Notch Filter Depth	Immediately
Pn41D	5000						Fifth Stage Notch Filter Frequency	Immediately
Pn41E	70						Fifth Stage Notch Filter Q Value	Immediately
Pn41F	0						Fifth Stage Notch Filter Depth	Immediately
Pn423	0000h						Speed Ripple Compensation Selections	*1
Pn424	50						Torque Limit at Main Circuit Voltage Drop	Immediately
Pn425	100						Release Time for Torque Limit at Main Circuit Voltage Drop	Immediately
Pn426	0						Torque Feedforward Average Movement Time	Immediately
Pn427	0						Speed Ripple Compensation Enable Speed	Immediately
Pn456	15						Sweep Torque Reference Amplitude	Immediately

Continued on next page.

Continued from previous page.

Parameter No.	Default Setting						Name	When Enabled
Pn460	0101h						Notch Filter Adjustment Selections 1	Immediately
Pn480	10000						Speed Limit during Force Control	Immediately
Pn481	400						Polarity Detection Speed Loop Gain	Immediately
Pn482	3000						Polarity Detection Speed Loop Integral Time Constant	Immediately
Pn483	30						Forward Force Limit	Immediately
Pn484	30						Reverse Force Limit	Immediately
Pn485	20						Polarity Detection Reference Speed	Immediately
Pn486	25						Polarity Detection Reference Acceleration/Deceleration Time	Immediately
Pn487	0						Polarity Detection Constant Speed Time	Immediately
Pn488	100						Polarity Detection Reference Waiting Time	Immediately
Pn48E	10						Polarity Detection Range	Immediately
Pn490	100						Polarity Detection Load Level	Immediately
Pn495	100						Polarity Detection Confirmation Force Reference	Immediately
Pn498	10						Polarity Detection Allowable Error Range	Immediately
Pn49F	0						Speed Ripple Compensation Enable Speed	Immediately
Pn502	20						Rotation Detection Level	Immediately
Pn503	10						Speed Coincidence Detection Signal Output Width	Immediately
Pn506	0						Brake Reference-Servo OFF Delay Time	Immediately
Pn507	100						Brake Reference Output Speed Level	Immediately
Pn508	50						Servo OFF-Brake Command Waiting Time	Immediately
Pn509	20						Momentary Power Interruption Hold Time	Immediately
Pn50A	0881h						Input Signal Selections 1	After restart
Pn50B	8881h						Input Signal Selections 2	After restart
Pn50E	0000h						Output Signal Selections 1	After restart
Pn50F	0100h						Output Signal Selections 2	After restart
Pn510	0000h						Output Signal Selections 3	After restart
Pn511	5432h						Input Signal Selections 5	After restart
Pn512	0000h						Output Signal Inverse Settings	After restart
Pn514	0000h						Output Signal Selections 4	After restart
Pn516	8888h						Input Signal Selections 7	After restart
Pn51E	100						Position Deviation Overflow Warning Level	Immediately
Pn520	5242880						Position Deviation Overflow Alarm Level	Immediately

Continued on next page.

Continued from previous page.

Parameter No.	Default Setting						Name	When Enabled
Pn522	7						Positioning Completed Width	Immediately
Pn524	1073741824						Near Signal Width	Immediately
Pn526	5242880						Position Deviation Overflow Alarm Level at Servo ON	Immediately
Pn528	100						Position Deviation Overflow Warning Level at Servo ON	Immediately
Pn529	10000						Speed Limit Level at Servo ON	Immediately
Pn52B	20						Overload Warning Level	Immediately
Pn52C	100						Base Current Derating at Motor Overload Detection	After restart
Pn530	0000h						Program Jogging-Related Selections	Immediately
Pn531	32768						Program Jogging Travel Distance	Immediately
Pn533	500						Program Jogging Movement Speed	Immediately
Pn534	100						Program Jogging Acceleration/Deceleration Time	Immediately
Pn535	100						Program Jogging Waiting Time	Immediately
Pn536	1						Program Jogging Number of Movements	Immediately
Pn550	0						Analog Monitor 1 Offset Voltage	Immediately
Pn551	0						Analog Monitor 2 Offset Voltage	Immediately
Pn552	100						Analog Monitor 1 Magnification	Immediately
Pn553	100						Analog Monitor 2 Magnification	Immediately
Pn55A	1						Power Consumption Monitor Unit Time	Immediately
Pn560	400						Residual Vibration Detection Width	Immediately
Pn561	100						Overshoot Detection Level	Immediately
Pn56A	0000h						Output Signal Reference Method Selections 1	After restart
Pn56B	0000h						Output Signal Reference Method Selections 2	After restart
Pn581	20						Zero Speed Level	Immediately
Pn582	10						Speed Coincidence Detection Signal Output Width	Immediately
Pn583	10						Brake Reference Output Speed Level	Immediately
Pn584	10000						Speed Limit Level at Servo ON	Immediately
Pn585	50						Program Jogging Movement Speed	Immediately
Pn586	0						Motor Running Cooling Ratio	Immediately

Continued on next page.

Continued from previous page.

Parameter No.	Default Setting						Name	When Enabled
Pn587	0000h						Polarity Detection Execution Selection for Absolute Linear Encoder	Immediately
Pn590	Axis A: 1003h, Axis B: 1009h						P-OT (Forward Drive Prohibit) Signal Allocation	After restart
Pn591	Axis A: 1004h, Axis B: 1010h						N-OT (Reverse Drive Prohibit) Signal Allocation	After restart
Pn592	Axis A: 1005h, Axis B: 1011h						/DEC (Origin Return Deceleration Switch Input) Signal Allocation	After restart
Pn593	Axis A: 1006h, Axis B: 1012h						/EXT1 (External Latch Input 1) Signal Allocation	After restart
Pn594	Axis A: 1007h, Axis B: 1013h						/EXT2 (External Latch Input 2) Signal Allocation	After restart
Pn595	Axis A: 1008h, Axis B: 1014h						/EXT3 (External Latch Input 3) Signal Allocation	After restart
Pn597	0000h						FSTP (Forced Stop Input) Signal Allocation	After restart
Pn598	0000h						/P-CL (Forward External Torque Limit Input) Signal Allocation	After restart
Pn599	0000h						/N-CL (Reverse External Torque Limit Input) Signal Allocation	After restart
Pn5B0	0000h						/COIN (Positioning Completion Output) Signal Allocation	After restart
Pn5B1	0000h						/V-CMP (Speed Coincidence Detection Output) Signal Allocation	After restart
Pn5B2	0000h						/TGON (Rotation Detection Output) Signal Allocation	After restart
Pn5B3	0000h						/S-RDY (Servo Ready) Signal Allocation	After restart
Pn5B4	0000h						/CLT (Torque Limit Detection Output) Signal Allocation	After restart
Pn5B5	0000h						/VLT (Speed Limit Detection) Signal Allocation	After restart
Pn5B6	Axis A: 1023h, Axis B: 1025h						/BK (Brake Output) Signal Allocation	After restart
Pn5B7	0000h						/WARN (Warning Output) Signal Allocation	After restart
Pn5B8	0000h						/NEAR (Near Output) Signal Allocation	After restart

Continued on next page.



Continued from previous page.

Parameter No.	Default Setting						Name	When Enabled
Pn5BC	0000h						/PM (Preventative Maintenance Output) Signal Allocation	After restart
Pn600	0						Regenerative Resistor Capacity	Immediately
Pn601	0						Dynamic Brake Resistor Allowable Energy Consumption	After restart
Pn603	0						Regenerative Resistance	Immediately
Pn604	0						Dynamic Brake Resistance	After restart
Pn61A	0000h						Overheat Protection Selections	After restart
Pn61B	250						Overheat Alarm Level	Immediately
Pn61C	100						Overheat Warning Level	Immediately
Pn61D	0						Overheat Alarm Filter Time	Immediately
Pn800	1040h						Communications Controls	Immediately
Pn801	0003h						Application Function Selections 6 (Software Limits)	Immediately
Pn803	10						Origin Range	Immediately
Pn804	1073741823						Forward Software Limit	Immediately
Pn806	-1073741823						Reverse Software Limit	Immediately
Pn808	0						Absolute Encoder Origin Offset	Immediately <sup>*2</sup>
Pn80A	100						First Stage Linear Acceleration Constant	Immediately <sup>*3</sup>
Pn80B	100						Second Stage Linear Acceleration Constant	Immediately <sup>*3</sup>
Pn80C	0						Acceleration Constant Switching Speed	Immediately <sup>*3</sup>
Pn80D	100						First Stage Linear Deceleration Constant	Immediately <sup>*3</sup>
Pn80E	100						Second Stage Linear Deceleration Constant	Immediately <sup>*3</sup>
Pn80F	0						Deceleration Constant Switching Speed	Immediately <sup>*3</sup>
Pn810	0						Exponential Acceleration/Deceleration Bias	Immediately <sup>*3</sup>
Pn811	0						Exponential Acceleration/Deceleration Time Constant	Immediately <sup>*3</sup>
Pn812	0						Movement Average Time	Immediately <sup>*3</sup>
Pn814	100						External Positioning Final Travel Distance	Immediately <sup>*3</sup>
Pn816	0000h						Origin Return Mode Settings	Immediately <sup>*3</sup>
Pn817	50						Origin Approach Speed 1	Immediately <sup>*3</sup>
Pn818	5						Origin Approach Speed 2	Immediately <sup>*3</sup>
Pn819	100						Final Travel Distance for Origin Return	Immediately <sup>*3</sup>

Continued on next page.

Continued from previous page.

Parameter No.	Default Setting						Name	When Enabled
Pn81E	0000h						Input Signal Monitor Selections	Immediately
Pn81F	0010h						Command Data Allocations	After restart
Pn820	0						Forward Latching Area	Immediately
Pn822	0						Reverse Latching Area	Immediately
Pn824	0000h						Option Monitor 1 Selection	Immediately
Pn825	0000h						Option Monitor 2 Selection	Immediately
Pn827	100						Linear Deceleration Constant 1 for Stopping	Immediately <sup>*3</sup>
Pn829	0						SVOFF Waiting Time (for SVOFF at Deceleration to Stop)	Immediately
Pn82A	1813h						Option Field Allocations 1	After restart
Pn82B	1D1Ch						Option Field Allocations 2	After restart
Pn82C	1F1Eh						Option Field Allocations 3	After restart
Pn82D	0000h						Option Field Allocations 4	After restart
Pn82E	0000h						Option Field Allocations 5	After restart
Pn833	0000h						Motion Settings	After restart
Pn834	100						First Stage Linear Acceleration Constant 2	Immediately <sup>*3</sup>
Pn836	100						Second Stage Linear Acceleration Constant 2	Immediately <sup>*3</sup>
Pn838	0						Acceleration Constant Switching Speed 2	Immediately <sup>*3</sup>
Pn83A	100						First Stage Linear Deceleration Constant 2	Immediately <sup>*3</sup>
Pn83C	100						Second Stage Linear Deceleration Constant 2	Immediately <sup>*3</sup>
Pn83E	0						Deceleration Constant Switching Speed 2	Immediately <sup>*3</sup>
Pn840	100						Linear Deceleration Constant 2 for Stopping	Immediately <sup>*3</sup>
Pn842	0						Second Origin Approach Speed 1	Immediately <sup>*3</sup>
Pn844	0						Second Origin Approach Speed 2	Immediately <sup>*3</sup>
Pn846	0						POSING Command Scurve Acceleration/Deceleration Rate	Immediately <sup>*3</sup>
Pn850	0						Number of Latch Sequences	Immediately
Pn851	0						Continuous Latch Sequence Count	Immediately
Pn852	0000h						Latch Sequence 1 to 4 Settings	Immediately
Pn853	0000h						Latch Sequence 5 to 8 Settings	Immediately
Pn860	0000h						SVCMD_IO Input Signal Monitor Allocations 1	Immediately
Pn861	0000h						SVCMD_IO Input Signal Monitor Allocations 2	Immediately
Pn862	0000h						SVCMD_IO Input Signal Monitor Allocations 3	Immediately

Continued on next page.

Continued from previous page.

Parameter No.	Default Setting						Name	When Enabled
Pn863	0000h						SVCMD_IO Input Signal Monitor Allocations 4	Immediately
Pn864	0000h						SVCMD_IO Input Signal Monitor Allocations 5	Immediately
Pn865	0000h						SVCMD_IO Input Signal Monitor Allocations 6	Immediately
Pn868	0000h						SVCMD_IO Output Signal Monitor Allocations 1	Immediately
Pn869	0000h						SVCMD_IO Output Signal Monitor Allocations 2	Immediately
Pn86A	0000h						SVCMD_IO Output Signal Monitor Allocations 3	Immediately
Pn880	-						Station Address Monitor (for maintenance, read only)	-
Pn881	-						Set Transmission Byte Count Monitor [bytes] (for maintenance, read only)	-
Pn882	-						Transmission Cycle Setting Monitor [ $\times 0.25 \mu\text{s}$ ] (for maintenance, read only)	-
Pn883	-						Communications Cycle Setting Monitor [transmission cycles] (for maintenance, read only)	-
Pn884	0000h						Communications Controls 2	Immediately
Pn88A	0						MECHATROLINK Receive Error Counter Monitor (for maintenance, read only)	-
Pn890 to Pn8A6	0h						Command Data Monitor during Alarm/Warning (for maintenance, read only)	-
Pn8A8 to Pn8BE	0h						Response Data Monitor during Alarm/Warning (for maintenance, read only)	-
Pn900	0						Number of Parameter Banks	After restart
Pn901	0						Number of Parameter Bank Members	After restart
Pn902 to Pn910	0h						Parameter Bank Member Definition	After restart
Pn920 to Pn95F	0h						Parameter Bank Data (Not saved in nonvolatile memory.)	Immediately
01 PnA02	-						Encoder Type Selection (read only)	-
02 PnA04	-						Motor Type Selection (read only)	-
04 PnA08	-						Rated Motor Speed (read only)	-
05 PnA0A	-						Maximum Output Speed (read only)	-
06 PnA0C	-						Speed Multiplier (read only)	-
07 PnA0E	-						Rated Torque (read only)	-
08 PnA10	-						Maximum Output Torque (read only)	-

Continued on next page.

Continued from previous page.

Parameter No.	Default Setting						Name	When Enabled
09 PnA12	–						Torque Multiplier (read only)	–
0A PnA14	–						Resolution (read only)	–
0B PnA16	0						Scale Pitch	After restart
0C PnA18	–						Pulses per Scale Pitch (read only)	–
21 PnA42	16						Electronic Gear Ratio (Numerator)	After restart
22 PnA44	1						Electronic Gear Ratio (Denominator)	After restart
23 PnA46	0						Absolute Encoder Origin Offset	Immediately*2
24 PnA48	65535						Multiturn Limit Setting	After restart
25 PnA4A	0000h						Limit Setting	After restart
26 PnA4C	1073741 823						Forward Software Limit	Immediately
27 PnA4E	0						Reserved (Do not change.)	Immediately
28 PnA50	-107374 1823						Reverse Software Limit	Immediately
29 PnA52	0						Reserved (Do not change.)	Immediately
41 PnA82	0h						Speed Unit Selection	After restart
42 PnA84	0						Speed Base Unit Selection	After restart
43 PnA86	0h						Position Unit Selection	After restart
44 PnA88	0						Position Base Unit Selection	After restart
45 PnA8A	0h						Acceleration Unit Selection	After restart
46 PnA8C	4						Acceleration Base Unit Selection	After restart
47 PnA8E	1h						Torque Unit Selection	After restart
48 PnA90	0						Torque Base Unit Selection	After restart
49 PnA92	0601011 Fh						Supported Unit Systems (read only)	–
61 PnAC2	40000						Speed Loop Gain	Immediately
62 PnAC4	20000						Speed Loop Integral Time Constant	Immediately
63 PnAC6	40000						Position Loop Gain	Immediately
64 PnAC8	0						Feedforward Compensation	Immediately
65 PnACA	0						Position Loop Integral Time Constant	Immediately

Continued on next page.

Continued from previous page.

Parameter No.	Default Setting						Name	When Enabled
66 PnACC	7						Positioning Completed Width	Immediately
67 PnACE	1073741 824						Near Signal Width	Immediately
81 PnB02	0						Exponential Acceleration/ Deceleration Time Constant	Immediately* <sup>3</sup>
82 PnB04	0						Movement Average Time	Immediately* <sup>3</sup>
83 PnB06	100						External Positioning Final Travel Distance	Immediately
84 PnB08	× 5,000h reference units/s converted to 10 <sup>-3</sup> min <sup>-1</sup>						Origin Approach Speed	Immediately
85 PnB0A	× 500h reference units/s converted to 10 <sup>-3</sup> min <sup>-1</sup>						Origin Return Creep Speed <sup>†</sup>	Immediately
86 PnB0C	100						Final Travel Distance for Origin Return	Immediately
87 PnB0E	1h						Fixed Monitor Selection 1	Immediately
88 PnB10	0h						Fixed Monitor Selection 2	Immediately
89 PnB12	0h						SEL_MON (CMN1) Monitor Selection 1	Immediately
8A PnB14	0h						SEL_MON (CMN2) Monitor Selection 2	Immediately
8B PnB16	10						Origin Detection Width	Immediately
8C PnB18	100						Forward Torque Limit	Immediately
8D PnB1A	100						Reverse Torque Limit	Immediately
8E PnB1C	20000						Zero Speed Detection Range	Immediately
8F PnB1E	10000						Speed Coincidence Signal Detection Width	Immediately
90 PnB20	0FFF3F3 Fh						Servo Command Control Field Enable/Disable Selec- tions (read only)	-
91 PnB22	0FFF3F3 3h						Servo Status Field Enable/ Disable Selections (read only)	-
92 PnB24	01FF01F 0h						Output Bit Enable/Disable Selections (read only)	-
93 PnB26	FF0FFEF Eh						Input Bit Enable/Disable Selections (read only)	-

\*1. The enable timing depends on the digit that is changed. Refer to the following section for details.

 11.1 List of Servo Parameters on page 11-2

- \*2. The parameter setting is enabled after SENS\_ON command execution is completed.
- \*3. Change the setting when the reference is stopped (i.e., while DEN is set to 1). If you change the setting during operation, the reference output will be affected.

# Appendices

---

# 12

The appendix provides information on interpreting panel displays, and tables of corresponding SERVOPACK and SigmaWin+ function names.

## **12.1** Interpreting Panel Displays ..... 12-2

- 12.1.1 Interpreting Status Displays ..... 12-2
- 12.1.2 Alarm and Warning Displays ..... 12-2
- 12.1.3 Overtravel Display ..... 12-2
- 12.1.4 Forced Stop Display ..... 12-2

## **12.2** Corresponding SERVOPACK and SigmaWin+ Function Names .. 12-3

- 12.2.1 Corresponding SERVOPACK Utility Function Names ..... 12-3
- 12.2.2 Corresponding SERVOPACK Monitor Display Function Names ..... 12-4

# 12.1 Interpreting Panel Displays

You can check the Servo Drive status on the panel display of the SERVOPACK.  
 Also, if an alarm or warning occurs, the alarm or warning number will be displayed.

## 12.1.1 Interpreting Status Displays

The status is displayed as described below.

Display	Meaning	Display	Meaning
	/TGON (Rotation Detection) Signal Display Lit if the Servomotor speed is higher than the setting of Pn502 or Pn581 and not lit if the speed is lower than the setting. (The default setting is 20 min <sup>-1</sup> or 20 mm/s.)		Reference Input Display Lit while a reference is being input.
	Base Block Display Lit during the base block state (servo OFF). Not lit while the servo is ON.		Control Power Supply ON Display Lit while the control power is being supplied.

**Information** The locations for the axes on the panel display are as follows:

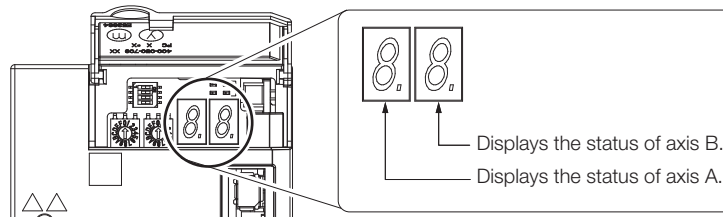

## 12.1.2 Alarm and Warning Displays

If there is an alarm or warning, the display will change in the following order.

Example: Alarm A.E60

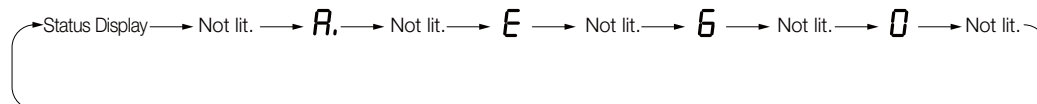

## 12.1.3 Overtravel Display

If overtravel has occurred, the display will change in the following order.

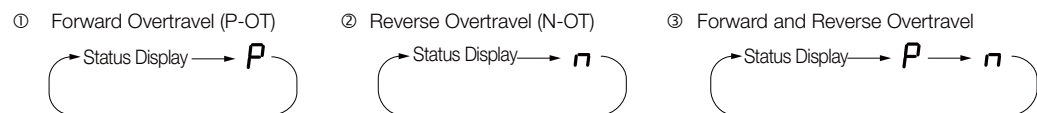

## 12.1.4 Forced Stop Display

During a forced stop, the following display will appear.

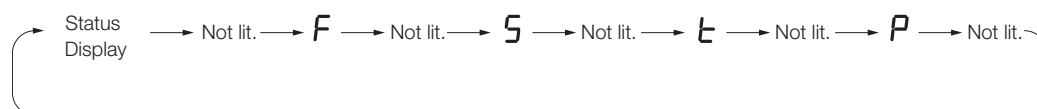



## 12.2 Corresponding SERVOPACK and SigmaWin+ Function Names

This section gives the names and numbers of the utility functions and monitor display functions used by the SERVOPACKs and the names used by the SigmaWin+.

### 12.2.1 Corresponding SERVOPACK Utility Function Names

SigmaWin+		SERVOPACK	
Button in Menu Dialog Box	Function Name	Fn No.	Function Name
Setup	Origin Search	Fn003	Origin Search
	Absolute Encoder Reset	Fn008	Reset Absolute Encoder
	Adjust the Analog Monitor Output	Fn00C	Adjust Analog Monitor Output Offset
		Fn00D	Adjust Analog Monitor Output Gain
	Adjust the Motor Current Detection Signal Offsets	Fn00E	Autotune Motor Current Detection Signal Offset
		Fn00F	Manually Adjust Motor Current Detection Signal Offset
	Multiturn Limit Setting	Fn013	Multiturn Limit Setting after Multiturn Limit Disagreement Alarm
	Initialize Vibration Detection Level	Fn01B	Initialize Vibration Detection Level
	Set Origin	Fn020	Set Absolute Linear Encoder Origin
	Reset Motor Type Alarm	Fn021	Reset Motor Type Alarm
	Software Reset	Fn030	Software Reset
	Polarity Detection	Fn080	Polarity Detection
Tuning-less Level Setting	Fn200	Tuning-less Level Setting	
Easy FFT	Fn206	Easy FFT	
Parameters	Initialize	Fn005	Initializing Parameters
	Write Prohibition Setting	Fn010	Write Prohibition Setting
	Setup Wizard	–	–
Tuning	Autotuning without Host Reference	Fn201	Advanced Autotuning without Reference
	Autotuning with Host Reference	Fn202	Advanced Autotuning with Reference
	Custom Tuning	Fn203	One-Parameter Tuning
	Adjust Anti-resonance Control	Fn204	Adjust Anti-resonance Control
	Vibration Suppression	Fn205	Vibration Suppression
Monitoring	Product Information	Fn011	Display Servomotor Model
		Fn012	Display Software Version
		Fn01E	Display SERVOPACK and Servomotor IDs
Test Operation	Jog	Fn002	Jog
	Jog Program	Fn004	Jog Program
Alarms	Alarm Display	Fn000	Display Alarm History
		Fn006	Clear Alarm History
Solutions	Mechanical Analysis	–	–

## 12.2.2 Corresponding SERVOPACK Monitor Display Function Names

If “All Axes” is given below the Un number, the monitor display applies to both axes. The total value for all axes or the contents for all axes are displayed on the monitor.

SigmaWin+		SERVOPACK	
Button in Menu Dialog Box	Name [Unit]	Un No.	Name [Unit]
Motion Monitor	Motor Speed [ $\text{min}^{-1}$ ]	Un000	Motor Speed [ $\text{min}^{-1}$ ]
	Speed Reference [ $\text{min}^{-1}$ ]	Un001	Speed Reference [ $\text{min}^{-1}$ ]
	Torque Reference [%]	Un002	Torque Reference [%] (percentage of rated torque)
	<ul style="list-style-type: none"> <li>Rotary Servomotors: Rotational Angle 1 [encoder pulses] (number of encoder pulses from origin within one encoder rotation)</li> <li>Linear Servomotors: Electrical Angle 1 [linear encoder pulses] (linear encoder pulses from the polarity origin)</li> </ul>	Un003	<ul style="list-style-type: none"> <li>Rotary Servomotors: Rotational Angle 1 [encoder pulses] (number of encoder pulses from origin within one encoder rotation displayed in decimal)</li> <li>Linear Servomotors: Electrical Angle 1 [linear encoder pulses] (linear encoder pulses from the polarity origin displayed in decimal)</li> </ul>
	<ul style="list-style-type: none"> <li>Rotary Servomotors: Rotational Angle 2 [deg] (electrical angle from origin within one encoder rotation)</li> <li>Linear Servomotors: Electrical Angle 2 [deg] (electrical angle from polarity origin)</li> </ul>	Un004	<ul style="list-style-type: none"> <li>Rotary Servomotors: Rotational Angle 2 [deg] (electrical angle from polarity origin)</li> <li>Linear Servomotors: Electrical Angle 2 [deg] (electrical angle from polarity origin)</li> </ul>
	Input Reference Pulse Speed [ $\text{min}^{-1}$ ]	Un007	Input Reference Pulse Speed [ $\text{min}^{-1}$ ] (displayed only during position control)
	Position Deviation [reference units]	Un008	Position Error Amount [reference units] (displayed only during position control)
	Accumulated Load Ratio [%]	Un009	Accumulated Load Ratio [%] (percentage of rated torque: effective torque in cycles of 10 seconds)
	Regenerative Load Ratio [%]	Un00A <u>All Axes</u>	Regenerative Load Ratio [%] (percentage of processable regenerative power: regenerative power consumption in cycles of 10 seconds)
	Dynamic Brake Resistor Power Consumption [%]	Un00B	Power Consumed by DB Resistance [%] (percentage of processable power at DB activation: displayed in cycles of 10 seconds)
	Input Reference Pulse Counter [reference units]	Un00C	Input Reference Pulse Counter [reference units]
	Feedback Pulse Counter [encoder pulses]	Un00D	Feedback Pulse Counter [encoder pulses]
	Total Operation Time [100 ms]	Un012 <u>All Axes</u>	Total Operation Time [100 ms]
	Feedback Pulse Counter [reference units]	Un013	Feedback Pulse Counter [reference units]
	Overheat Protection Input [0.01 V]	Un02F	Overheat Protection Input [0.01 V]
Current Backlash Compensation Value [0.1 reference units]	Un030	Current Backlash Compensation Value [0.1 reference units]	
Backlash Compensation Value Setting Limit [0.1 reference units]	Un031	Backlash Compensation Value Setting Limit [0.1 reference units]	

Continued on next page.

Continued from previous page.

SigmaWin+		SERVOPACK	
Button in Menu Dialog Box	Name [Unit]	Un No.	Name [Unit]
Motion Monitor	Power Consumption [W]	Un032 All Axes	Power Consumption [W]
	Consumed Power [0.001 Wh]	Un033 All Axes	Consumed Power [0.001 Wh]
	Cumulative Power Consumption [Wh]	Un034 All Axes	Cumulative Power Consumption [Wh]
	Absolute Encoder Multiturn Data	Un040	Absolute Encoder Multiturn Data
	Position within One Rotation of Absolute Encoder [encoder pulses]	Un041	Position within One Rotation of Absolute Encoder [encoder pulses]
	Lower Bits of Absolute Encoder Position [encoder pulses]	Un042	Lower Bits of Absolute Encoder Position [encoder pulses]
	Upper Bits of Absolute Encoder Position [encoder pulses]	Un043	Upper Bits of Absolute Encoder Position [encoder pulses]
Status Monitor	Polarity Sensor Signal Monitor	Un011	Polarity Sensor Signal Monitor
	Active Gain Monitor	Un014	Effective Gain Monitor (gain settings 1 = 1, gain settings 2 = 2)
Input Signal Monitor	Input Signal Monitor	Un005	Input Signal Monitor
		Un050 All Axes	All Input Signal Monitor 1
		Un052 All Axes	All Input Signal Monitor 2
Output Signal Monitor	Output Signal Monitor	Un006	Output Signal Monitor
		Un051 All Axes	All Output Signal Monitor
Service Life Monitor	Installation Environment Monitor – SERVOPACK	Un025 All Axes	SERVOPACK Installation Environment Monitor [%]
	Installation Environment Monitor – Servomotor*	Un026*	Servomotor Installation Environment Monitor [%]
	Service Life Prediction Monitor – Built-in Fan	Un027 All Axes	Built-in Fan Remaining Life Ratio [%]
	Service Life Prediction Monitor – Capacitor	Un028 All Axes	Capacitor Remaining Life Ratio [%]
	Service Life Prediction Monitor – Surge Prevention Circuit	Un029 All Axes	Surge Prevention Circuit Remaining Life Ratio [%]
	Service Life Prediction Monitor – Dynamic Brake Circuit	Un02A	Dynamic Brake Circuit Remaining Life Ratio [%]
Product Information	Motor – Resolution	Un084	Linear Encoder Pitch (Scale pitch = $Un084 \times 10^{Un085}$ [µm])
		Un085	Linear Encoder Pitch Exponent (Scale pitch = $Un084 \times 10^{Un085}$ [µm])
–	–	Un020	Rated Motor Speed [ $\text{min}^{-1}$ ]
	–	Un021	Maximum Motor Speed [ $\text{min}^{-1}$ ]

\* This applies to the following motors. The display will show 0 for all other models.  
SGM7M, SGM7J, SGM7A, SGM7P, SGM7G, SGM7E, SGM7F, and SGM7C

# Index

## Symbols

/BK - - - - -	5-34
/BK (Brake) signal- - - - -	5-34
/CLT (Torque Limit Detection) signal - - - - -	6-26
/COIN - - - - -	6-13
/COIN (Positioning Completion) signal - - - - -	6-13
/N-CL - - - - -	6-23
/N-CL (Reverse External Torque Limit) signal - - - - -	6-23
/NEAR - - - - -	6-14
/NEAR (Near) signal - - - - -	6-14
/P-CL - - - - -	6-23
/P-CL (Forward External Torque Limit) signal- - - - -	6-23
/S-RDY - - - - -	6-12
/TGON- - - - -	6-11
/TGON (Rotation Detection) signal - - - - -	6-11
/V-CMP - - - - -	6-12
/V-CMP (Speed Coincidence Detection) signal - - - - -	6-12
/VLT - - - - -	6-15
/VLT (Speed Limit Detection) signal - - - - -	6-15
/WARN - - - - -	6-10
/WARN (Warning) signal- - - - -	6-10

## A

A.CC0 - - - - -	6-30
absolute encoder - - - - -	6-27
origin offset - - - - -	5-51
resetting - - - - -	5-48
wiring - - - - -	4-22
AC power supply input	
setting - - - - -	5-13
additional adjustment functions - - - - -	8-68
alarm reset possibility - - - - -	10-5
alarm tracing - - - - -	9-17
ALM - - - - -	6-10
ALM (Servo Alarm) signal - - - - -	6-10
Analog Monitor Connector - - - - -	4-42
analog monitor factors- - - - -	9-10
anti-resonance control- - - - -	8-52
automatic detection of connected motor - - - - -	5-15
automatic gain switching - - - - -	8-69
automatic notch filters - - - - -	8-32
autotuning with a host reference - - - - -	8-35
autotuning without a host reference - - - - -	8-24

## B

backlash compensation - - - - -	8-76
base block (BB) - - - - -	x
battery	
replacement - - - - -	10-3

block diagram - - - - -	2-8
brake operation delay time - - - - -	5-33
brake release delay time- - - - -	5-33

## C

CCW - - - - -	5-16
clearing alarm history - - - - -	10-40
CN1 - - - - -	4-33
CN2A - - - - -	4-21
CN2B - - - - -	4-21
CN5 - - - - -	4-42
CN502 - - - - -	4-41
CN6A - - - - -	4-40
CN6B - - - - -	4-40
CN7 - - - - -	4-41
coasting - - - - -	5-38
coasting to a stop- - - - -	5-38
coefficient of speed fluctuation - - - - -	2-7
compatible adjustment functions - - - - -	8-92
Computer Connector- - - - -	4-41
countermeasures against noise - - - - -	4-6
current gain level setting - - - - -	8-75
custom tuning - - - - -	8-43
CW - - - - -	5-16

## D

DC power supply input - - - - -	4-12
setting- - - - -	5-13
wiring example - - - - -	4-17
DC Reactor	
terminals - - - - -	4-11
wiring - - - - -	4-20
decelerating to a stop - - - - -	5-38
detection timing for Overload Alarms (A.720) - - - - -	5-42
detection timing for Overload Warnings (A.910) - - - - -	5-41
diagnostic tools - - - - -	8-96
displaying alarm history - - - - -	10-39
dynamic brake applied- - - - -	5-38
dynamic brake stopping- - - - -	5-38

## E

EasyFFT - - - - -	8-97
electronic gear - - - - -	5-43
encoder resolution - - - - -	5-45
estimating the moment of inertia - - - - -	8-16
External Regenerative Resistor - - - - -	5-54
external torque limits - - - - -	6-23

## F

feedback pulse counter - - - - -	5-23
feedforward- - - - -	8-33, 8-92
feedforward compensation - - - - -	8-92
FG - - - - -	4-34

- forward rotation - - - - - 5-16  
friction compensation - - - - - 8-33, 8-72
- G**
- gain switching- - - - - 8-68  
gravity compensation - - - - - 8-74  
grounding - - - - - 4-9  
group 1 alarms - - - - - 5-39  
group 2 alarms - - - - - 5-39  
G-SEL - - - - - 8-69
- H**
- holding brake - - - - - 5-33
- I**
- I/O signals  
    allocations - - - - - 6-3  
    functions - - - - - 4-33  
    monitoring - - - - - 9-5  
    names - - - - - 4-33  
    wiring example- - - - - 4-36  
initializing the vibration detection level - - - - - 6-37  
input signals  
    allocations - - - - - 6-3  
internal torque limits - - - - - 6-22  
I-P control - - - - - 8-89
- J**
- jogging - - - - - 7-7
- L**
- limiting torque- - - - - 6-22  
Linear Encoder  
    wiring example- - - - - 4-22  
linear encoder  
    feedback resolution- - - - - 5-46  
    scale pitch setting- - - - - 5-17  
Linear Servomotor - - - - - x  
list of alarms- - - - - 10-5  
list of MECHATROLINK-III common parameters - - - - - 11-54  
list of parameters- - - - - 11-2  
    MECHATROLINK-III common parameters- - - - - 11-54  
list of warnings - - - - - 10-42
- M**
- Main Circuit Cable - - - - - X  
manual gain switching - - - - - 8-69  
manual tuning- - - - - 8-82  
mechanical analysis - - - - - 8-96  
mode switching (changing between proportional  
and PI control) - - - - - 8-93  
Momentary Power Interruption Hold Time - - - - - 6-17  
monitor factors - - - - - 9-10  
Motion Monitor - - - - - 9-3
- motor current detection signal  
    automatic adjustment - - - - - 6-41  
    manual adjustment - - - - - 6-43  
    offset - - - - - 6-41  
motor direction setting - - - - - 5-16  
motor maximum speed - - - - - 6-20  
motor overload detection level - - - - - 5-41  
multiturn limit - - - - - 6-28  
Multiturn Limit Disagreement - - - - - 6-30
- N**
- Noise Filter - - - - - 4-7  
Noise Filter connection precautions - - - - - 4-8  
N-OT - - - - - 5-28, 5-29  
N-OT (Reverse Drive Prohibit) signal- - - - - 5-29  
notch filters - - - - - 8-85, 8-88
- O**
- operation for momentary power interruptions - - - - - 6-17  
origin search- - - - - 7-20  
overheat protection - - - - - 6-48  
Overheat Protection Input - - - - - 4-33  
overload warnings - - - - - 5-41  
overtravel- - - - - 5-28  
    warnings- - - - - 5-31
- P**
- parameter settings recording table- - - - - 11-63  
parameters  
    classification - - - - - 5-3  
    initializing parameter settings- - - - - 5-9  
    notation (numeric settings) - - - - - xi, 5-4  
    notation (selecting functions)- - - - - xi, 5-4  
    setting methods - - - - - 5-5  
    write prohibition setting - - - - - 5-6  
photocoupler input circuits- - - - - 4-38  
photocoupler output circuits- - - - - 4-39  
PI control- - - - - 8-89  
polarity detection - - - - - 5-25  
polarity sensor - - - - - 5-24  
position integral- - - - - 8-95  
position loop gain - - - - - 8-83  
positioning completed width- - - - - 6-14  
P-OT - - - - - 5-28, 5-29  
P-OT (Forward Drive Prohibit) signal- - - - - 5-29  
program jogging - - - - - 7-14  
    operation pattern - - - - - 7-14
- R**
- reactors  
    DC reactor Connection terminal - - - - - 4-12  
    DC reactor wiring - - - - - 4-20  
reference unit - - - - - 5-43

Regenerative Resistor  
     connection - - - - - 4-19  
 regenerative resistor - - - - - 5-54  
 regenerative resistor capacity - - - - - 5-54  
 resetting alarms - - - - -10-38  
 Rotary Servomotor - - - - - x

**S**

safety functions  
     monitoring - - - - - 9-5  
 scale pitch - - - - - 5-17  
 selecting the phase sequence for a Linear Servomotor - 5-22  
 selecting torque limits - - - - - 6-22  
 SEMI F47 function - - - - - 6-18  
 Serial Communications Connector - - - - - 4-41  
 Serial Converter Unit - - - - - 5-17  
 Servo Drive - - - - - x  
 servo gains - - - - - 8-82  
 servo lock - - - - - x  
 servo OFF - - - - - x  
 servo ON - - - - - x  
 Servo System - - - - - x  
 Servomotor - - - - - x  
 Servomotor stopping method for alarms - - - - - 5-39  
 SERVOPACK - - - - - x  
     inspections and part replacement - - - - - 10-2  
     part names - - - - - 1-4  
     ratings - - - - - 2-2  
     specifications - - - - - 2-5  
 setting the origin - - - - - 5-51  
 setting the position deviation overflow alarm level - - - - - 8-8  
 setting the position deviation overflow alarm level  
 at servo ON - - - - - 8-10  
 setup parameters - - - - - 5-3  
 SG - - - - - 4-34  
 SigmaWin+ - - - - - x  
 signal allocations - - - - - 6-3  
 single-phase AC power supply input  
     setting - - - - - 5-14  
 single-phase, 200-VAC power supply input  
     wiring example - - - - - 4-16  
 sink circuits - - - - - 4-38  
 software limits - - - - - 6-21  
 software reset - - - - - 6-34  
 source circuits - - - - - 4-38  
 speed detection method selection - - - - - 8-76  
 speed limit during torque control - - - - - 6-15  
 speed loop gain - - - - - 8-84  
 speed loop integral time constant - - - - - 8-84  
 Spring Opener - - - - - 4-12  
 Status Monitor - - - - - 9-3  
 stopping by applying the dynamic brake - - - - - 5-38  
 stopping method for servo OFF - - - - - 5-38

storage humidity - - - - - 2-5  
 storage temperature - - - - - 2-5  
 surrounding air humidity - - - - - 2-5  
 surrounding air temperature - - - - - 2-5  
 switching condition A - - - - - 8-69

**T**

test without a motor - - - - - 7-23  
 TH\_A - - - - - 4-33  
 TH\_B - - - - - 4-33  
 three-phase AC power supply input  
     setting - - - - - 5-14  
 three-phase, 200-VAC power supply input - - - - - 4-11  
     wiring example - - - - - 4-15  
 torque reference filter - - - - - 8-85  
 troubleshooting alarms - - - - - 10-10  
 troubleshooting warnings - - - - - 10-44  
 tuning parameters - - - - - 5-4  
 tuning-less  
     load level - - - - - 8-14  
     rigidity level - - - - - 8-14  
 tuning-less function - - - - - 8-12

**V**

vibration suppression - - - - - 8-57

**W**

writing parameters - - - - - 5-18

**Z**

zero clamping - - - - - 5-38  
 zero-speed stopping - - - - - 5-38

## Revision History

The revision dates and numbers of the revised manuals are given on the bottom of the back cover.

MANUAL NO. SIEP S800001 63B <1>  
 Published in Japan May 2015

Revision number

Date of publication

Date of Publication	Rev. No.	Section	Revised Contents
April 2018	<8>	Preface	Partly revised.
		4.3.1	Revision: Specifications for L1C and L2C
December 2017	<7>	Preface	Partly revised.
		Preface, 1.4.2, 1.5.1, 5.12.1, 5.15.1	Addition: Information on Rotary Servomotors (SGM7M)
		1.2	Revision: Information on nameplate
		Back cover	Revision: Address
March 2017	<6>	Preface, 10.5	Partly revised.
		4.4.3, 5.15.1	Addition: Information on SQ47 and SQ57 Linear Encoders from Magnescale Co., Ltd.
		5.15.1	Addition: Information on LIC2100-Series and LC415 Linear Encoders from Heidenhain Corporation.
		5.15.1, 5.17.2	Addition: Information on RESOLUTE Linear Encoders from Renishaw PLC.
		6.1.2	Addition: Information on forcing outputs with MECHATROLINK-III commands
		11.1.2	Revisions: Reference information
		Chapter 11	Addition: Pn56A and Pn56B
December 2016	<5>	Preface	Partly revised.
		1.4.2, 4.4.2, 4.4.3, 5.16.1, 5.17, 6.12	Addition: Information on Rotary Servomotors with 24-bit batteryless absolute encoders.
		Back cover	Revision: Address
October 2016	<4>	All chapters	Addition: Information on Direct Drive Servomotors (SGM7E)
		Preface	Partly revised.
		2.1.3, 4.2, 4.5	Revision: "Linear Servomotor overheat protection signal input" changed to "overheat protection input."
		3.7	Addition: EMC installations for single-phase 200-VAC models
		4.4.3, 5.15.1, 5.17.2	Addition: Absolute linear encoders from Renishaw PLC (models: EL36Y-□□□□□□□□)
		6.13, 8.12.3	Newly added.
		Chapter 10	Addition: A.862 and A.93B
		Chapter 11	Addition: Pn022, Pn475, Pn476, Pn61A, Pn61B, Pn61C, and Pn61D
		12.2.2	Addition: Un02F
May 2016	<3>	All chapters	Addition: Information on SGM7F Direct Drive Servomotors Addition: Information on dynamic brake option
		1.5.3	Deletion: Information on SGLC Linear Servomotors
		Chapters 1, 2, 3	Addition: Information on SGD7W-5R5A and -7R6A
		2.1.1	Addition: Information on input current of control power supply
		Preface, 9.1, 9.2	Partly revised.
		Chapter 11	Deletion: Pn52D

Date of Publication	Rev. No.	Section	Revised Contents
December 2015	<2>	All chapters	Addition: Information on SERVOPACKs with single-phase, 100-VAC power supply inputs Revision: Information on SigmaWin+ procedures
		Preface	Addition: Information on SGMMV Rotary Servomotors Revision: Information on certification for standards
		Chapter 1	Addition: Information on SGMMV Rotary Servomotors
		1.5.2	Addition: Information on Direct Drive Servomotors (SGMCMV-16D and -35D)
		4.4.3, 5.15.1	Addition: Information on SQ10 Linear Encoder from Magnescale Co., Ltd.
		9.4.1	Partly revised.
		9.5	Addition: Alarm tracing
		Chapter 10	Additions: A.bF5, A.bF6, A.bF7, A.bF8, and FL-6
		Back cover	Revision: Address
		May 2015	<1>
All chapters	Addition: Information on Safety Modules Addition: Information on dynamic brake		
Preface	Revision: Information on certification for standards		
2.1.1	Revision: Power loss		
4.2, 4.4.3, 4.5.3	Revision: Diagrams around Battery for absolute encoder		
5.15.1, 5.17.2	Addition: Information on Linear Encoders (ST1381 and ST1382) from Mitutoyo Corporation		
6.1.10	Revision: Information on speed limit during torque control		
7.6.3	Revision: Information on test without a motor		
8.3.3, 8.3.5	Revision: Related Parameters Addition: Related Warnings		
8.12.3, 13.1.2	Revision: Information on current control mode selection		
Chapters 10, 11	Revision: Reference information		
Chapter 10	Revision: Information on A.900, A.910, and A.911		
Chapter 11	Deletion: Pn51B Revision: Information on Pn601 and Pn604 Addition: Pn846		
October 2014	–	–	First edition



# Σ-7-Series AC Servo Drive

# Σ-7W SERVOPACK with

# MECHATROLINK-III

# Communications References

# RJ-45 Connectors

# Product Manual

---

#### **IRUMA BUSINESS CENTER (SOLUTION CENTER)**

480, Kamifujisawa, Iruma, Saitama, 358-8555, Japan  
Phone: +81-4-2962-5151 Fax: +81-4-2962-6138  
<http://www.yaskawa.co.jp>

#### **YASKAWA AMERICA, INC.**

2121, Norman Drive South, Waukegan, IL 60085, U.S.A.  
Phone: +1-800-YASKAWA (927-5292) or +1-847-887-7000 Fax: +1-847-887-7310  
<http://www.yaskawa.com>

#### **YASKAWA ELÉTRICO DO BRASIL LTDA.**

777, Avenida Piraporinha, Diadema, São Paulo, 09950-000, Brasil  
Phone: +55-11-3585-1100 Fax: +55-11-3585-1187  
<http://www.yaskawa.com.br>

#### **YASKAWA EUROPE GmbH**

Hauptstraße 185, 65760 Eschborn, Germany  
Phone: +49-6196-569-300 Fax: +49-6196-569-398  
<http://www.yaskawa.eu.com> E-mail: [info@yaskawa.eu.com](mailto:info@yaskawa.eu.com)

#### **YASKAWA ELECTRIC KOREA CORPORATION**

35F, Three IFC, 10 Gukjegeumyung-ro, Yeongdeungpo-gu, Seoul, 07326, Korea  
Phone: +82-2-784-7844 Fax: +82-2-784-8495  
<http://www.yaskawa.co.kr>

#### **YASKAWA ELECTRIC (SINGAPORE) PTE. LTD.**

151, Lorong Chuan, #04-02A, New Tech Park, 556741, Singapore  
Phone: +65-6282-3003 Fax: +65-6289-3003  
<http://www.yaskawa.com.sg>

#### **YASKAWA ELECTRIC (THAILAND) CO., LTD.**

59, 1st-5th Floor, Flourish Building, Soi Ratchadapisek 18, Ratchadapisek Road, Huaykwang, Bangkok, 10310, Thailand  
Phone: +66-2-017-0099 Fax: +66-2-017-0799  
<http://www.yaskawa.co.th>

#### **YASKAWA ELECTRIC (CHINA) CO., LTD.**

22F, One Corporate Avenue, No.222, Hubin Road, Shanghai, 200021, China  
Phone: +86-21-5385-2200 Fax: +86-21-5385-3299  
<http://www.yaskawa.com.cn>

#### **YASKAWA ELECTRIC (CHINA) CO., LTD. BEIJING OFFICE**

Room 1011, Tower W3 Oriental Plaza, No.1, East Chang An Ave.,  
Dong Cheng District, Beijing, 100738, China  
Phone: +86-10-8518-4086 Fax: +86-10-8518-4082

#### **YASKAWA ELECTRIC TAIWAN CORPORATION**

12F, No. 207, Sec. 3, Beishin Rd., Shindian Dist., New Taipei City 23143, Taiwan  
Phone: +886-2-8913-1333 Fax: +886-2-8913-1513 or +886-2-8913-1519  
<http://www.yaskawa.com.tw>

---

## **YASKAWA**

**YASKAWA ELECTRIC CORPORATION**

In the event that the end user of this product is to be the military and said product is to be employed in any weapons systems or the manufacture thereof, the export will fall under the relevant regulations as stipulated in the Foreign Exchange and Foreign Trade Regulations. Therefore, be sure to follow all procedures and submit all relevant documentation according to any and all rules, regulations and laws that may apply. Specifications are subject to change without notice for ongoing product modifications and improvements.

© 2014 YASKAWA ELECTRIC CORPORATION

MANUAL NO. SIEP S800001 63I <8>

Published in Japan April 2018

17-4-13

Original instructions